

User Guide

Vaisala Polaris Process Refractometer
PR53 Series

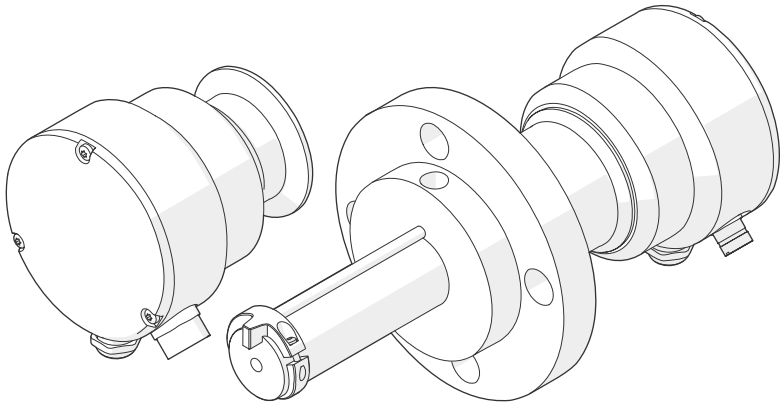

PUBLISHED BY

Vaisala Oyj
Vanha Nurmijärventie 21, FI-01670 Vantaa, Finland
P.O. Box 26, FI-00421 Helsinki, Finland
+358 9 8949 1
www.vaisala.com
docs.vaisala.com

© Vaisala 2024

No part of this document may be reproduced, published, or publicly displayed in any form or by any means, electronic or mechanical (including photocopying), nor may its contents be modified, translated, adapted, sold, or disclosed to a third party without prior written permission of the copyright holder. Translated documents and translated portions of multilingual documents are based on the original English versions. In ambiguous cases, the English versions are applicable, not the translations.

The contents of this document are subject to change without prior notice.

Local rules and regulations applicable to the products and services may vary and they shall take precedence over the information contained in this document. Vaisala makes no representations on this document's compliance with the local rules and regulations applicable at any given time, and hereby disclaims any and all responsibilities related thereto. You are instructed to confirm the applicability of the local rules and regulations and their effect on the intended use of the products and services.

This document does not create any legally binding obligations for Vaisala towards customers or end users. All legally binding obligations are set forth exclusively in the applicable contract or in the relevant set of General Conditions of Vaisala (www.vaisala.com/policies).

This product contains software developed by Vaisala or third parties. Use of the software is governed by license terms and conditions included in the applicable contract or, in the absence of separate license terms and conditions, by the General License Conditions of Vaisala Group.

This product may contain open-source software (OSS) components. In the event this product contains OSS components, then such OSS is governed by the terms and conditions of the applicable OSS licenses, and you are bound by the terms and conditions of such licenses in connection with your use and distribution of the OSS in this product. Applicable OSS licenses are included in the product itself or provided to you on any other applicable media, depending on each individual product and the product items delivered to you.

Table of contents

1.	About this document	9
1.1	Version information.....	9
1.2	Related manuals.....	9
1.3	Documentation conventions.....	10
1.4	Trademarks.....	11
1.5	Patent notice.....	11
2.	Product overview	12
2.1	Safety.....	12
2.1.1	ESD protection.....	12
2.2	Product nomenclature.....	12
2.3	PR53 product overview.....	13
2.4	PR53 refractometer models.....	13
2.5	Refractometer structure.....	15
2.6	Storing and transporting.....	16
3.	Refractometer connections	17
3.1	Refractometer connections.....	17
3.2	System wiring.....	18
3.3	Wiring considerations.....	20
4.	User interfaces	22
4.1	Refractometer LED indicators.....	22
4.2	Indigo520 user interfaces.....	23
4.3	Vaisala Insight PC software.....	24
4.4	Modbus RTU.....	24
4.5	Analog output.....	24
5.	Start-up	26
5.1	Start-up.....	26
5.1.1	Starting up stand-alone refractometer.....	26
5.1.2	Starting up refractometer with Indigo520.....	26
6.	Using refractometer with Vaisala Indigo520	28
6.1	Vaisala Indigo520 transmitter.....	28
6.2	Connecting to Indigo520.....	28
6.3	General settings.....	29
6.4	Diagnostics menu.....	29
6.4.1	Viewing refractometer status.....	29
6.5	Concentration measurement.....	29
6.5.1	Overview of concentration measurement.....	29
6.5.2	Concentration curve.....	30
6.5.3	Field sample.....	34
6.5.4	Field calibration service.....	34

6.6	RI calibration.....	34
6.6.1	Preparing RI calibration.....	35
6.6.2	Performing RI calibration with Indigo520.....	36
6.7	Configuring analog outputs with Indigo520.....	37
6.8	Signal damping.....	37
6.8.1	Exponential damping.....	37
6.8.2	Linear damping.....	38
6.8.3	Slew rate limit.....	39
7.	Using refractometer with Vaisala Insight software.....	41
7.1	Insight PC software.....	41
7.2	Connecting to Insight software.....	41
7.3	Insight main view.....	43
7.3.1	Basic and Advanced user modes.....	44
7.4	Concentration measurement.....	44
7.4.1	Overview of concentration measurement.....	44
7.4.2	Concentration curve.....	45
7.4.3	Field sample.....	50
7.5	RI calibration.....	50
7.5.1	Preparing RI calibration.....	51
7.5.2	Performing RI calibration with Insight.....	51
7.5.3	Completing RI calibration.....	52
7.6	RI adjustment.....	53
7.6.1	Overwriting factory adjustment.....	53
7.7	Temperature adjustment.....	53
7.7.1	Adjusting temperature using previously measured value.....	54
7.8	Blank image.....	54
7.8.1	Creating blank image.....	55
7.9	Configuring analog output.....	55
7.9.1	Adjusting output level for analog output 1.....	56
7.9.2	Configuring analog output signal damping.....	57
7.10	Configuring Modbus communication settings with Insight.....	60
7.11	Restoring factory settings.....	61
8.	Preventive maintenance.....	62
8.1	Preventive maintenance.....	62
8.2	Cleaning refractometer and prism.....	62
9.	Troubleshooting.....	64
9.1	Troubleshooting messages.....	64
9.2	Diagnostic message priorities.....	68
9.3	Measurement status details.....	69
9.4	Calibration check.....	70
9.5	RI calibration failure.....	70
10.	Technical data.....	72
10.1	Compatibility.....	72
10.2	PR53 common specifications.....	72

10.3	PR53AC specifications.....	74
10.4	PR53AP specifications.....	77
10.5	PR53GC specifications.....	80
10.6	PR53GP specifications.....	82
10.7	Spare parts and accessories.....	85
10.7.1	Interconnecting cable specifications.....	85
10.8	Recycling instructions.....	85
11.	Modbus registers.....	88
11.1	Modbus registers.....	88
Appendix A: Principle of measurement.....		98
Appendix B: Analyzing optical image.....		100
Maintenance and calibration services.....		103
Warranty.....		103
Technical support.....		103

List of figures

Figure 1	Refractometer equipment.....	13
Figure 2	PR53 refractometer structure.....	15
Figure 3	Connecting wires inside the refractometer (Modbus RTU or Indigo520).....	17
Figure 4	Connecting wires inside the refractometer (analog output).....	18
Figure 5	Wiring diagram for PR53 and Indigo520.....	19
Figure 6	Wiring diagram for PR53 and analog output.....	19
Figure 7	Wiring diagram for PR53 and Modbus RTU.....	20
Figure 8	Wiring PR53 to Indigo520.....	21
Figure 9	PR53 main circuit board.....	22
Figure 10	Indigo520 transmitter.....	23
Figure 11	Connecting refractometer to Indigo520.....	28
Figure 12	Concentration measurement layers.....	30
Figure 13	Exponential damping.....	38
Figure 14	Linear damping.....	39
Figure 15	Slew rate damping.....	40
Figure 16	Connecting refractometer to Insight.....	42
Figure 17	Concentration measurement layers.....	45
Figure 18	Exponential damping.....	58
Figure 19	Linear damping.....	59
Figure 20	Slew rate damping.....	60
Figure 21	PR53AC process temperature, options Sanitary 2.5" and Type N (indicative).....	75
Figure 22	PR53AC process pressure.....	75
Figure 23	PR53AP process temperature (indicative).....	78
Figure 24	PR53AP process pressure.....	78
Figure 25	PR53GC process temperature (indicative).....	81
Figure 26	PR53GC process pressure.....	81
Figure 27	PR53GP process temperature (indicative).....	83
Figure 28	PR53GP process pressure.....	83
Figure 29	Materials for recycling.....	86
Figure 30	Refractometer principle.....	98
Figure 31	Optical images.....	99
Figure 32	Optical image detection.....	99

List of tables

Table 1	Document versions (English).....	9
Table 2	Related manuals.....	10
Table 3	Product nomenclature.....	12
Table 4	Default Modbus communication settings	24
Table 5	C-parameters.....	31
Table 6	C-parameters.....	46
Table 7	Preventive maintenance.....	62
Table 8	Hardware troubleshooting.....	64
Table 9	Measurement troubleshooting.....	65
Table 10	Diagnostic message priorities.....	68
Table 11	Measurement status details.....	69
Table 12	Measurement performance.....	72
Table 13	Inputs and outputs.....	72
Table 14	Compliance.....	73
Table 15	Operating environment.....	74
Table 16	Sanitary compliance.....	75
Table 17	Mechanical specifications.....	76
Table 18	Operating environment.....	77
Table 19	Sanitary compliance.....	78
Table 20	Mechanical specifications.....	79
Table 21	Operating environment.....	80
Table 22	Mechanical specifications.....	81
Table 23	Operating environment.....	82
Table 24	Mechanical specifications.....	84
Table 25	Interconnecting cable specifications.....	85
Table 26	Materials for recycling.....	86
Table 27	Measurement data registers (read-only).....	88
Table 28	Measurement diagnostic registers (read-only).....	88
Table 29	Status registers (read-only).....	89
Table 30	Error code encoding.....	89
Table 31	Device information registers (read-only).....	90
Table 32	Configuration registers.....	91
Table 33	Concentration curve configuration registers.....	93
Table 34	Test value registers.....	96
Table 35	Device identification objects.....	96
Table 36	Analyzing the optical image.....	100
Table 37	Prism scaling.....	101

1. About this document

1.1 Version information

This document provides instructions for using and maintaining PR53 process refractometers.

Table 1 Document versions (English)

Document code	Date	Description
M212898EN-C	February 2024	<p>This document.</p> <p>Added sections:</p> <ul style="list-style-type: none"> • System wiring (page 18) • Wiring considerations (page 20) • Starting up stand-alone refractometer (page 26) • Starting up refractometer with Indigo520 (page 26) • Managing concentration curves (page 33) • Blank image (page 54) • Measurement status details (page 69) <p>Updated sections:</p> <ul style="list-style-type: none"> • Product nomenclature (page 12) • PR53 product overview (page 13) • Refractometer structure (page 15) • Refractometer LED indicators (page 22) • Start-up (page 26) • Diagnostics menu (page 29) • Concentration curve (page 30) • Concentration curve parameters (page 31) • Troubleshooting messages (page 64)
M212898EN-B	October 2023	<p>Previous version.</p> <p>Added sections:</p> <ul style="list-style-type: none"> • PR53AP specifications (page 77) • PR53GC specifications (page 80) • Cleaning refractometer and prism (page 62) <p>Updated sections:</p> <ul style="list-style-type: none"> • Refractometer connections (page 17)
M212898EN-A	May 2023	First version.

1.2 Related manuals



For the latest versions of these documents, see docs.vaisala.com.

Table 2 Related manuals

Document code	Name
M212866EN	Vaisala Polaris Process Refractometer PR53AC Installation Guide
M212932EN	Vaisala Polaris Process Refractometer PR53AP Installation Guide
M212931EN	Vaisala Polaris Process Refractometer PR53GC Installation Guide
M212873EN	Vaisala Polaris Process Refractometer PR53GP Installation Guide
M212808EN	Vaisala Polaris Process Refractometer PR53 Prism Wash System User Guide
M212287EN	Vaisala Indigo500 Series Transmitters User Guide

1.3 Documentation conventions



WARNING! Warning alerts you to a serious hazard. If you do not read and follow instructions carefully at this point, there is a risk of injury or even death.



CAUTION! Caution warns you of a potential hazard. If you do not read and follow instructions carefully at this point, the product could be damaged or important data could be lost.



Highlights important information on using the product.



Gives information for using the product more efficiently.



Lists tools needed to perform the task.



Indicates that you need to take some notes during the task.

1.4 Trademarks

Vaisala®, Polaris™, and Indigo™ are trademarks of Vaisala Oyj.

Modbus® is a registered trademark of Schneider Automation Inc.

All other product or company names that may be mentioned in this publication are trade names, trademarks, or registered trademarks of their respective owners.

1.5 Patent notice

This product is protected by the following patents and patent applications and their corresponding national rights:

- US2019391074A1

2. Product overview

2.1 Safety

This product has been tested for safety according to IEC 61010-1. Note the following precautions:



WARNING! Only licensed experts may install electrical components. They must adhere to local and state legislation and regulations.

2.1.1 ESD protection

Electrostatic discharge (ESD) can damage electronic circuits. Vaisala products are adequately protected against ESD for their intended use. However, it is possible to damage the product by delivering electrostatic discharges when touching, removing, or inserting any objects in the equipment housing.

To avoid delivering high static voltages to the product:

- Handle ESD-sensitive components on a properly grounded and protected ESD workbench or by grounding yourself to the equipment chassis with a wrist strap and a resistive connection cord.
- If you are unable to take either precaution, touch a conductive part of the equipment chassis with your other hand before touching ESD-sensitive components.
- Hold component boards by the edges and avoid touching component contacts.

2.2 Product nomenclature

Table 3 Product nomenclature

Item	Name
CCD camera	Charge Coupled Device camera, line camera in the refractometer optics.
LA	Light area, sector of an optical image that corresponds to the light that is reflected.
RI	Refractive index, number that indicates how much the path of light is bent, or refracted, when entering a material.
QF	Quality factor, dimensionless value, depicting the quality (sharpness) of the optical image. Changes in QF may indicate coating of the prism.

2.3 PR53 product overview

The PR53 inline refractometer is an instrument for measuring liquid concentration in the process line. The measurement is based on the refraction of light in the process medium, an accurate and safe way of measuring liquid concentration.

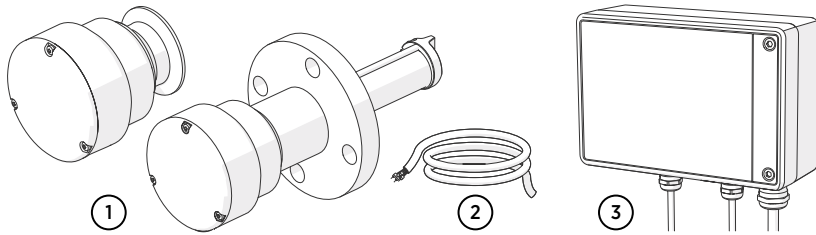

Figure 1 Refractometer equipment

- 1 Vaisala Polaris™ Process Refractometers
- 2 Interconnecting cables
- 3 Vaisala Indigo520 Transmitter (optional)

The inline process refractometer (1) measures the refractive index (RI) and the temperature of the process medium. Using a pre-defined concentration model, the refractometer uses the measurement data to calculate the concentration. The output value can be read directly from the refractometer through configurable integrated analog output channel, or through the Modbus RTU interface. Alternatively, it can be connected to the optional Indigo520 (3) transmitter using the interconnecting cable (2).

Indigo520 is a configurable transmitter, containing 4 configurable analog output channels, 2 binary contact control relays, Modbus TCP/IP output, a web server and a graphical touch panel display. The current values and trend data may be read from the Indigo520, which also contains a local data logger. One or two refractometers can be connected to one Indigo520 transmitter. For service purposes, the PR53 refractometer can be connected directly to an Indigo80 handheld indicator, or to a PC using a USB adapter and Vaisala Insight software.

2.4 PR53 refractometer models

There are different PR53 refractometer models. Each model is adapted for different process requirements.

- **The Vaisala Polaris PR53AC** sanitary compact process refractometer is designed to measure liquid concentrations, such as Brix.
- **The Vaisala Polaris PR53AP** sanitary probe process refractometer is designed for food and beverage, dairy and brewery industry customers, and OEMs to measure liquid concentrations, such as Brix, in applications such as jam cookers and mixing tanks.

- **The Vaisala Polaris PR53GC** general-purpose compact process refractometer is designed for measuring concentrations of acids, alkaline solutions, alcohols, hydrocarbons, solvents, and various other solutions.
- **The Vaisala Polaris PR53GP** general-purpose probe process refractometer is designed for measuring concentrations of sugars/Brix, acids, alkaline solutions, hydrocarbons, solvents, and various other solutions.
- **The Vaisala Polaris PR53M** PTFE-body process refractometer is designed to measure concentrations of aggressive chemicals, such as hydrochloric acid (HCl), sodium hydroxide (NaOH), sodium chloride (NaCl), and sulfuric acid (H₂SO₄) in the chemical and semiconductor industries.
- **The retractable Vaisala Polaris PR53SD** Safe-Drive process refractometer is designed for safety-critical measurements in pulp mills, such as firing liquor concentration. The Safe-Drive system with a PR53SD refractometer enables safe sensor insertion and removal also when the process line is in full operation.
- **The Vaisala Polaris PR53W** valve-body process refractometer is designed to measure concentrations of aggressive chemicals, such as sulfuric acid, hydrochloric acid (HCl), and sodium hydroxide (NaOH) in production pipelines such as in the chemical, biochemical, and pharmaceutical industries.

PR53AC and PR53AP have been designed to be used in food contact applications and meet the 3-A and EHEDG sanitary standard requirements.

2.5 Refractometer structure

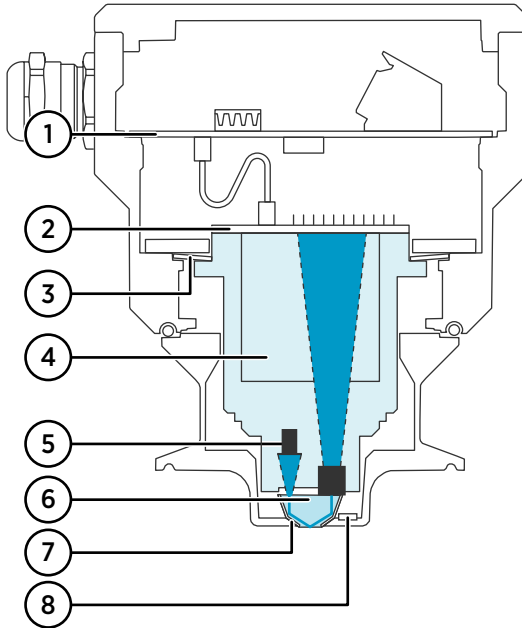

Figure 2 PR53 refractometer structure

- 1 Main circuit board
- 2 CCD Charge Coupled Device
- 3 Disc springs
- 4 CORE-Module
- 5 Light source
- 6 Prism
- 7 Prism gasket
- 8 Integrated temperature sensor

The measurement prism (6) is flush-mounted to the surface of the probe tip. The prism (6) and all the other optical components are fixed to the solid CORE-Module (4), which is springloaded (3) against the prism gasket (8). The light source (5) is a yellow LED, emitting light with 589 nm wavelength (Sodium D-line wavelength), which is a standard in refractive index values in literature. The main circuit board (1) receives the raw data from the CCD Charge Coupled Device (2) and the process temperature sensor (7), and then calculates the refractive index RI, the process temperature T, and process concentration according to a predefined concentration curve. This information is transmitted to the user with integrated analog output channel, digital Modbus RTU, or Indigo520 transmitter.

2.6 Storing and transporting

Soft shell packaging prevents damage to the components of the refractometer. Transport the device in its original packaging.

Before storing, remove any dirt and grease from the refractometer and make sure that it is dry.

Storage conditions:

- Temperature: -40 ... +40 °C (-40 ... +104 °F)
- Humidity: No condensation

3. Refractometer connections

3.1 Refractometer connections

The refractometer has built-in isolated 4–20 mA analog output channel, which represents the output of the refractometer. The output range and the engineering unit depend on the concentration curve used; for example, if the unit is configured with 0–100 °Brix output, the scaling of the output channel is 4 mA = 0 °Brix and 20 mA = 100 °Brix. The default error state indication level is 3.6 mA. The output is configurable: The output value (refractive index, temperature, concentration, quality factor), scaling, and error status indication level can be configured using the Vaisala Insight software and a USB adapter.

The connection header also has an RS-485 port. This allows using the refractometer directly as a Modbus RTU server device. Alternatively, the same port is used to connect the refractometer to an Indigo520 transmitter.

For digital communications, see [Modbus RTU \(page 24\)](#).

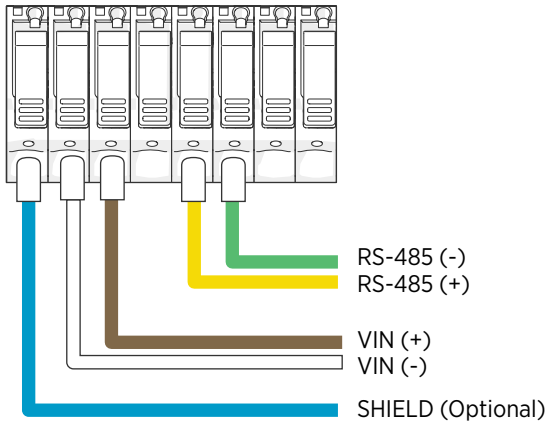

Figure 3 Connecting wires inside the refractometer (Modbus RTU or Indigo520)

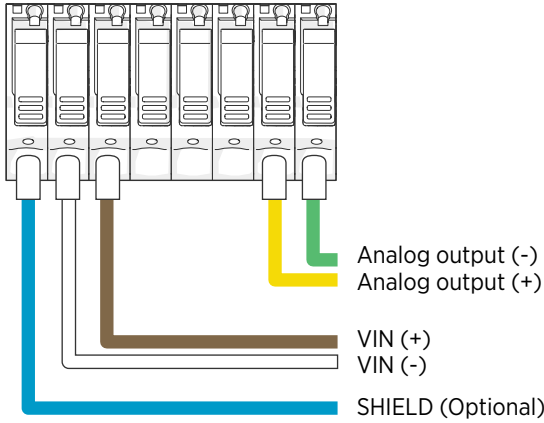

Figure 4 Connecting wires inside the refractometer (analog output)

More information

- [Starting up refractometer with Indigo520 \(page 26\)](#)

3.2 System wiring



The analog and Modbus RTU wiring configurations are examples of system wiring. Your system may differ from the wiring examples presented here.



It is recommended to connect Shield into the cable gland or metal conduit hub.

Indigo520 wiring

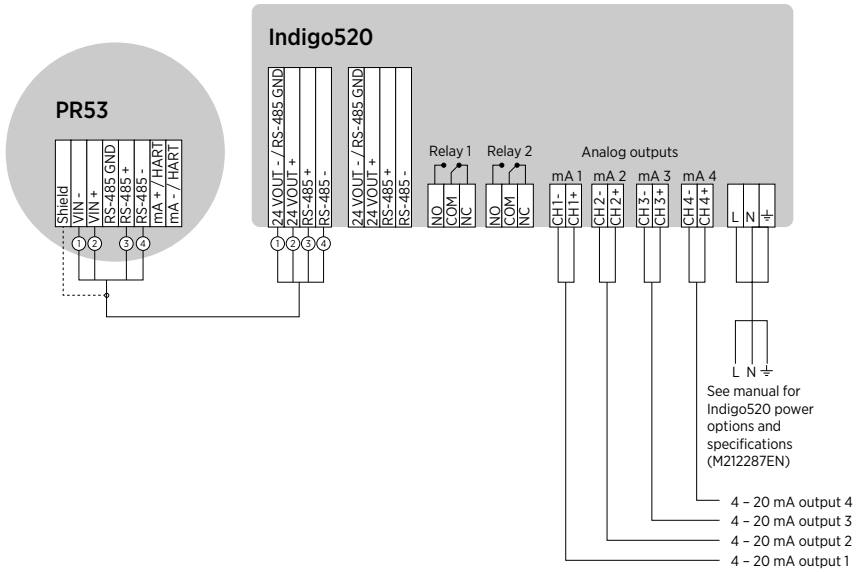

Figure 5 Wiring diagram for PR53 and Indigo520

Analog system

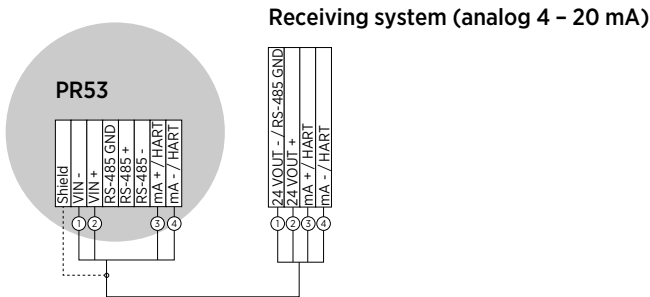

Figure 6 Wiring diagram for PR53 and analog output

Modbus RTU system

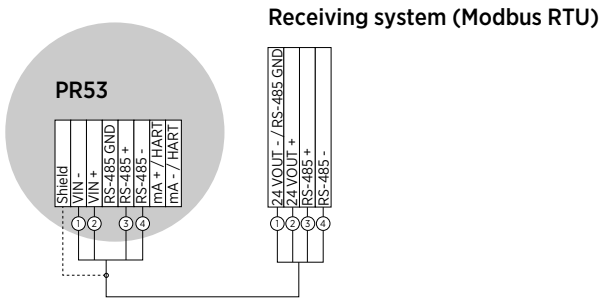

Figure 7 Wiring diagram for PR53 and Modbus RTU

3.3 Wiring considerations

The chassis ground and ground terminal are electrically connected. Grounding can be done either by connecting the cable shield to the respective terminal in the wiring header, or alternatively by connecting the cable shield to the cable gland.

The integrated mA signal is galvanically isolated from the power supply in order to minimize the possibility of ground loops.

The signal ground of the integrated RS485 bus signal ground is galvanically connected to the power supply ground. Consider grounding to avoid the effect of ground loops in the RS485 bus.

The signal cable shield should be connected to the PR53 chassis ground. Grounding through the cable gland is recommended. Alternatively, the cable shield can be connected to the SHIELD pin in the wiring header.

Consider the grounding of the PR53 refractometer in situations where the device is connected to non-conductive (such as glass fiber) pipelines in order to avoid static electricity.

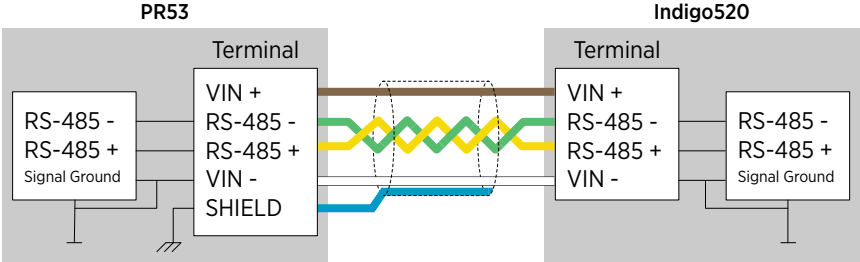

Figure 8 Wiring PR53 to Indigo520

4. User interfaces

4.1 Refractometer LED indicators

The LED indicators are used to indicate the status of the refractometer when used without the Indigo520 transmitter.

The color of the LED corresponds to the severity:

- **Green** indicates normal operation and power on.
- **Blinking green** indicates successful digital communication to the RS485 port. When the green LED blinks, the refractometer has successfully received and responded to a Modbus request, or received successful communication from the Indigo520 transmitter.
- **Yellow** indicates warning status. You need to attach the refractometer to Modbus, the Indigo520 transmitter, Indigo80 handheld indicator or Insight software.
- **Red** indicates a critical failure where user interference is required. When the red LED is on, the refractometer may need to be sent to Vaisala for service. Contact helpdesk@vaisala.com.

The error codes can be read either through the Indigo520 transmitter, Modbus RTU port, Indigo80 handheld indicator, or Vaisala Insight software with a USB adapter.

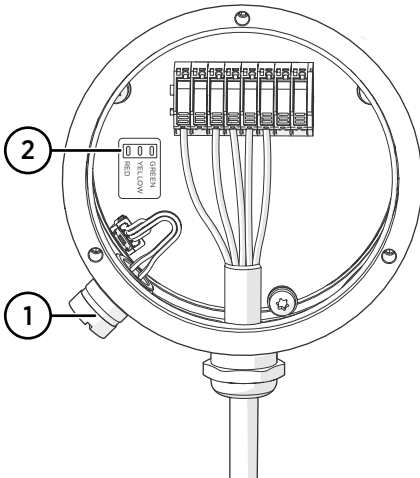

Figure 9 PR53 main circuit board

- 1 Service port
- 2 LED indicators

4.2 Indigo520 user interfaces

Vaisala Indigo520 is a transmitter that accommodates maximum of two PR53 refractometers for liquid measurements. The transmitter can display measurements on the spot as well as transmit them to automation systems through analog signals, control relays, or Modbus TCP/IP protocol.

Indigo520 can be used with two interfaces:

- Touch screen display
- Web interface

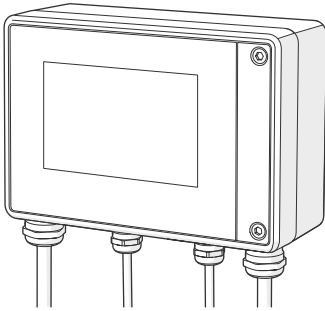

Figure 10 Indigo520 transmitter

Indigo520 provides:

- Easy-to-use touch panel display
- Web-based user interface
- Data logging
- Status and diagnostics info
- Optical image diagnostics
- Wash system control

The PR53 prism wash system is controlled and configured with Indigo520. In most applications the prism keeps clean due to the self-cleaning effect. If coating occurs, your application may require a wash system.

For more information on the use of Indigo520, see [Indigo500 User Guide \(M212287EN\)](#).

More information

- [Connecting to Indigo520 \(page 28\)](#)
- [Vaisala Indigo520 transmitter \(page 28\)](#)

4.3 Vaisala Insight PC software

Vaisala Insight PC software is a configuration software for Indigo-compatible probes and other supported devices. Insight is available for Microsoft Windows® operating systems (64-bit only).

With the Insight software, you can:

- See device information and status.
- See real-time measurement data.
- Manage concentration curves
- Calibrate and adjust the device.

Download Insight at www.vaisala.com/insight.

The refractometer can be connected to Insight using a Vaisala Indigo USB adapter (item code USB2).

More information

- [Connecting to Insight software \(page 41\)](#)

4.4 Modbus RTU

The Modbus variant used in PR53 series refractometers is Modbus RTU.

The following table lists the default communication settings used when Modbus is enabled at the factory (chosen when ordering).

Table 4 Default Modbus communication settings

Description	Default value
Baud rate	19200
Parity	No parity
Number of data bits	8
Number of stop bits	2

More information

- [Configuring Modbus communication settings with Insight \(page 60\)](#)
- [Modbus registers \(page 88\)](#)

4.5 Analog output

PR53 process refractometers provide one scalable analog output channel with 4–20 mA current output.

When PR53 is connected to Indigo520, Indigo provides more analog output channels. The integrated analog output channel and the Indigo520 analog outputs are independent from each other, and can also be used simultaneously.

For configuring analog output with Indigo520, see [Indigo500 User Guide \(M212287EN\)](#).

For configuring analog output with Insight, see [Configuring analog output \(page 55\)](#).

Error state levels

PR53 process refractometers have two configurable error state levels.

- Default: 3.4 mA
- Secondary error state: Enabled, 3.2 mA

There are 4 error state messages, in rising severity order:

1. Info
2. Warning
3. Error
4. Critical

More information

- [Configuring analog output \(page 55\)](#)
- [Diagnostic message priorities \(page 68\)](#)

5. Start-up

5.1 Start-up

The PR53 unit is configured at the factory and ready to be used. The concentration model has been set up according to the order. If the concentration model needs to be changed, it can be done using the service port and Insight software.

More information

- [Uploading concentration curves \(page 49\)](#)

5.1.1 Starting up stand-alone refractometer

- ▶ 1. Connect the refractometer to the receiving system either with the analog output channel or Modbus RTU.

The refractometer is now ready to measure and transmit measurement signals.

2. Check the LED - green light indicates that the power is on.
3. If Modbus RTU is used, change the RS-485 communication parameters and the Modbus unit ID as needed by using the Insight software and a USB adapter.
4. After the wiring is made, check that the green LED blinks when the master system polls the values.

This indicates that the refractometer has successfully received a request and responded to a Modbus request made to its unit ID.

More information

- [System wiring \(page 18\)](#)
- [Configuring Modbus communication settings with Insight \(page 60\)](#)

5.1.2 Starting up refractometer with Indigo520

- ▶ 1. Connect the refractometer to the Indigo520 transmitter using the interconnecting cable. Make sure the 8th character of the configuration code on the Indigo520 type label is "L".
- 2. Connect the wires from the refractometer to Indigo520 probe port 1 or 2 according to chapter Refractometer connections.

Indigo520 transmitter provides the power supply for the refractometer and initializes the communication with the sensor automatically.

3. After the refractometer has been detected, configure the numerical and graphical display views and analog output channels using the Indigo520 display or the web user interface. See [Indigo500 User Guide \(M212287EN\)](#) for details.



If you have the optional prism wash system installed, you need to perform a prism wash test. See [PR53 Prism Wash System User Guide \(M212808EN\)](#).

More information

- [Refractometer connections \(page 17\)](#)

6. Using refractometer with Vaisala Indigo520

6.1 Vaisala Indigo520 transmitter

With Vaisala Indigo520 Transmitter, you can:

- View the refractometer status
- Adjust concentration measurement
- RI calibration
- Configure analog output channel
- Configure analog output signal damping
- Configure refractometer prism washes

For the full user guide, see [Indigo500 User Guide \(M212287EN\)](#).

6.2 Connecting to Indigo520

Before connecting the wires or cables, make sure that the transmitter is powered off.

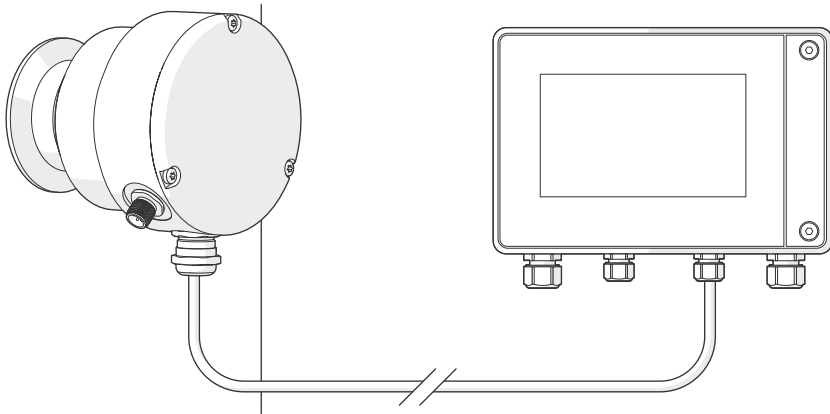

Figure 11 Connecting refractometer to Indigo520

- ▶ 1. Open the 2 hex screws on the cover of the transmitter using a 4-mm Allen key.
2. Open the transmitter cover.
3. Connect the wires inside the refractometer.

For more information on connecting the refractometer, see model-specific installation guide.

4. Connect the wires inside the transmitter, see [Indigo500 User Guide \(M212287EN\)](#).

6.3 General settings

You can edit the general settings of the refractometer in **Menu > <your refractometer> > General**.

In **General**, you can give a custom name to the refractometer.

6.4 Diagnostics menu

You can view various diagnostic and measurement values in the **Diagnostics** menu. From Indigo software version 1.16.2 onwards, you can find the **Diagnostics** menu from **Menu > <your refractometer> > Diagnostics**. In older Indigo software versions the **Diagnostics** view is the fourth **Home** view.

In **Diagnostics**, you can perform the following actions:

- Take a **Field sample**.
 - Field sample is a sample of the calculated average of 10 consequent measurements.
 - The samples are shown in a window so that they can be registered for later use.
- Start a **Prism wash**.
 - Activate a configured prism wash.
 - View any configured prism washes and drainings.
 - See diagnostics of the previous prism wash.

6.4.1 Viewing refractometer status

The refractometer status is shown in **Diagnostics**. The status **Normal operation** is shown when there are no active errors.

6.5 Concentration measurement

Adjustment of the raw concentration value may be required to compensate for some process conditions or to fit the measurement to the laboratory results.

There are four presets that each have their own C and F parameters that can be stored in their memory slots.

6.5.1 Overview of concentration measurement

The concentration measurement is organized in 6 layers.

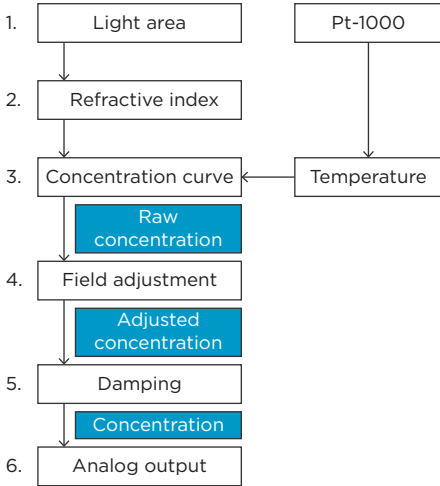

Figure 12 Concentration measurement layers

- 1 Light area information comes from the CCD element and temperature information from Pt-1000 temperature element. The position of the shadow edge is light area and scaled 0–100 %.
- 2 RI adjustment: The actual refractive index RI is calculated from the light area. The temperature is calculated from the Pt-1000 resistance. The RI measurement of each refractometer can be verified using standard nominal reference liquids.
- 3 Concentration curve: The refractometer calculates raw concentration from RI and temperature according to the chemical curve. The result is a temperature-compensated raw concentration value.
- 4 Field adjustment: Adjustment of the raw concentration value may be required to compensate for some process conditions or to fit the measurement to the laboratory results. The field adjustment parameters are used to convert raw concentration into adjusted concentration. The adjusted concentration is called concentration. If there is no adjustment, raw concentration and adjusted concentration are equal.
- 5 Damping: You can apply signal damping to diminish the influence of process noise.
- 6 Output signal: The range of the 4–20 mA signal is defined by its 2 endpoints on the concentration scale.

More information

- [Principle of measurement \(page 98\)](#)

6.5.2 Concentration curve

Concentration curve consists of:

- Actual concentration curve parameters (C-parameters, engineering unit, valid temperature and concentration ranges)

- Related field adjustment parameters (F-parameters)
- Alias name

6.5.2.1 Concentration curve parameters

Concentration curve is the theoretical concentration curve based on RI and temperature. It is defined by a set of 16 parameters, C-parameters.

A concentration curve is specific to the given process medium, for example, sucrose or sodium hydroxide. The set of parameters is given by Vaisala. Do not alter the C-parameters, except if you are changing to another process medium.

There are 4 parallel concentration curves in the refractometer internal memory. They can be changed via Indigo520, Insight or Modbus.



The primary method for correcting the concentration measurement is field adjustment. However, in some cases the linear field adjustment may not be enough and the C-parameters may require fine-tuning. In this case, please contact Vaisala helpdesk for support. Concentration curve contains also other information besides the C-parameters (for example, measurement unit, valid concentration and temperature ranges, and similar).

Table 5 C-parameters

C ₀₀	C ₀₁	C ₀₂	C ₀₃
C ₁₀	C ₁₁	C ₁₂	C ₁₃
C ₂₀	C ₂₁	C ₂₂	C ₂₃
C ₃₀	C ₃₁	C ₃₂	C ₃₃

More information

- [Field adjustment parameters \(page 31\)](#)
- [Changing concentration curves \(page 33\)](#)

6.5.2.2 Field adjustment parameters

The field adjustment can be calculated with the following pattern: **Adjusted concentration = Raw concentration × Field gain + Field offset**

Each concentration curve has its own field adjustment. If you change the concentration curve, field adjustment is no longer the same.

To edit the field gain and field offset,

1. Go to **Menu > Concentration curves**.
2. Select the concentration curve and **Modify adjustment**.
3. Modify **Offset** and **Gain**.

To check which concentration curve is active, see [Changing concentration curves \(page 33\)](#).

Accurate calibration is only achieved if the sample is taken correctly. Pay special attention to following details:

- Field adjustment using the process liquid must always be made inline.
- The sampling valve and the refractometer should be installed close to each other in the process.



WARNING! Wear protective clothing appropriate to your process when operating the sampling valve and handling the sample.

- Run the sample before starting to collect data points to avoid sampling old process liquid that has remained in the sampling valve.
- Read the raw concentration value at exactly the same time with sampling. The easiest way of doing this is to use the Field sample feature. The value of each sample is the average of 10 consequent measurements to increase accuracy and reduce possible process noise.
- Use a tight container for the sample to avoid evaporation.



Offline calibration using process liquid very seldom gives reliable results, as problems are caused by:

- Low flow which makes sample to form an unrepresentative film on the prism
- Sample evaporation at high temperature or undissolved solids at low temperature giving deviations from laboratory determinations
- An aging sample which is not representative
- Outside light reaching the prism

More information

- [Field sample \(page 34\)](#)
- [Changing concentration curves \(page 33\)](#)
- [Concentration curve parameters \(page 31\)](#)

6.5.2.3 Calculating field adjustment

To calculate field gain and field offset, you need to take samples from the process liquid.

- ▶ 1. Take samples from the process liquid and take a field sample.
2. Repeat as many times as needed.

To calculate offset and gain you need at least two points. Take samples from process conditions with a wide span in the measurement range.

3. Calculate field gain and field offset from the data points.

4. Type the values to **Offset** and **Gain**.

If there is already a previous field calibration, before calculating the offset and gain values for a new field calibration, reset the values as follows:

- **Offset:** 0
- **Gain:** 1

More information

- [Field sample \(page 34\)](#)

6.5.2.4 Managing concentration curves

There are 3 different cases in which you may need to change the concentration curve:

- Switching active concentration curve to another curve that has been configured in the refractometer. For example, switching between Brix, Oeschle, NaOH. This can be done using Indigo520, Insight, Modbus RTU, or Indigo80.
- Changing a preconfigured concentration curve or adding a completely new curve. For example, changing from Brix 0–100 °Bx to NaOH 0–50 g/l. This is done by using the Insight software.
- Finetuning the C-parameters of a preconfigured concentration curve. This can be done by using Indigo520 or Insight.

More information

- [Uploading concentration curves \(page 49\)](#)

6.5.2.5 Changing concentration curves

The PR53 refractometer is able to hold up to 4 concentration curves in its memory. By default, the unit is delivered with one concentration curve pre-configured at the factory as ordered. Additional concentration curves can be added using the Insight software and a USB adapter. Multiple concentration curves pre-configured at the factory are available as a tailored order.

Do not alter the concentration curve parameters, except if you are changing to another process medium. If you are unsure what to do, contact helpdesk@vaisala.com.

A concentration curve is specific to the given process medium, for example, sucrose or sodium hydroxide. The set of parameters is given by Vaisala. Do not alter the concentration curve parameters, except if you are changing to another process medium.

- ▶ 1. You can select the concentration curve in **Menu > Concentration curves**.

2. You can change the C parameters in **Menu > Concentration curves > View parameters > Modify parameters**.

Changing from one concentration curve to another changes the way concentration is calculated from monitored liquids. The refractometer will restart to apply the change.



If any concentration limit warnings have been set, they may be triggered by the change.

More information

- [Field adjustment parameters \(page 31\)](#)
- [Field sample \(page 34\)](#)
- [Concentration curve parameters \(page 31\)](#)

6.5.3 Field sample

A field sample is a measurement taken from the process that has the calculated average of 10 consequent measurements. A field sample is usually taken when a snapshot of the process condition is needed.

To take a field sample, browse to the Diagnostics view and select **Field sample**.

6.5.4 Field calibration service

Vaisala provides a field calibration service that adapts the calibration to the factory laboratory determinations based on the data supplied. The field calibration procedure should be made under normal process conditions using standard laboratory determinations of sample concentration.

Email the data to your local Vaisala representative. Vaisala makes a computer analysis of the data and sends optimal calibration parameters to be entered into the Indigo520 transmitter or Insight PC software.

Record the calibrating data in **Configure device > Concentration curve N > Field offset** and **Field gain**. For a complete report, 10–15 valid data points (see below) are needed. A data point is of use for calibration only when there are no active errors or warnings. If prism wash is employed, do not take samples during the wash. Each data point consists of:

- LAB%: Sample concentration determined by the user.
- Raw concentration value: Calculated concentration value.

In addition to the calibration data, write down the refractometer serial number.

6.6 RI calibration

RI calibration ensures that the measurement of the refractometer is accurate.

The refractometer comes with a calibration certificate which ensures that it has fulfilled the measurement criteria when sent from the factory. RI calibration is needed when the optics of the device is serviced and RI adjustment needs to be performed.

Calibration is done to find out if there is measurement error in the device in the defined measurement area; adjustment is performed to fix the error.



RI adjustment can only be performed with Insight.

In order to perform RI calibration, you need:

- Indigo520 transmitter or Vaisala Insight software
- Sample holder
- Cleaning solution
- Tissues
- Nominal reference RI liquids, see below
- Protective clothing
- Environment with a good ventilation

Nominal reference RI liquids

There are two prism types, each of which have their own nominal reference RI liquid sets. You can check which prism your refractometer has from the configuration code by the side of the refractometer.

- H72
- H73



CAUTION! Each liquid has their own safety instructions with them. Read the instructions carefully before you start RI calibration.

6.6.1 Preparing RI calibration

Before you begin RI calibration, you must perform preparatory actions.

- ▶ 1. Remove the refractometer from the process and place it on a table, prism pointing upwards.
2. Clean the prism and the sample holder with ethanol cleaning solution. Make sure by looking closely that the prism is clean.
3. Mount the sample holder on the prism.
4. Prepare the necessary refractive index reference liquids and de-ionized water (sample liquids) and place them near the refractometer.

5. Let the refractometer and sample liquid temperature settle to room temperature, +20 ... +30 °C (+68 ... +86 °F). Calibration must be done within this temperature range.



The cooling of the refractometer may take several hours.

6.6.2 Performing RI calibration with Indigo520

- ▶ 1. Go to **Menu** and select the refractometer.
2. Select **RI calibration > Calibrate**.



RI calibration can be done using either the touch screen or web interface. When calibration is being performed on one user interface, the other cannot be used at the same time.

3. Read the instructions on the screen and select **Ok**.



From this point onwards, the process is semi-automated and you will be guided through the process on the screen.

4. Add a calibration point by pressing **+** and selecting the reference RI you want to calibrate against.
 - When calibrating, the refractometer waits for the temperature measurement to stabilize. This may take up to 4 minutes.
 - After nominal RI is selected, the refractometer calculates the correct reference RI at the measured temperature.



Do not hold the refractometer or sample liquid container in your hand or near external heat sources during calibration. Changes in the refractometer or sample liquid temperature may decrease the measurement quality of the point or cause the calibration of the point to fail.

5. Once temperature measurement has stabilized, the UI will request you to apply sample liquid onto the sample holder and place the light cover on top.

The calibration process will happen automatically from this point on with the following steps:

- a. Detecting sample
- b. Waiting for the sample to stabilize
- c. Calibrating

- Once the calibration process is ready, results are displayed in the results screen.



You can later view the results of a calibrated point by selecting a calibration point tile from the calibration view.

You can now choose the following:

- **Close:** Closes the summary screen and returns to calibration view
- **Recalibrate point:** Calibrates the point again
- **Delete point:** Removes the calibrated point.

- Repeat the process for other available points as needed.
- Finalize calibration by selecting **Complete calibration**. This will replace old calibration data with the new data.

You can also do the following:

- **Optical image:** View refractometer status, diagnostic values and both optical and slope image.
- **Cancel calibration:** Quit the calibration process. Old calibration data is not replaced.

The result screen shows the difference between reference value and measured value, some diagnostic values, and the status of a single calibration point.

6.7 Configuring analog outputs with Indigo520

To configure analog outputs, see [Indigo500 User Guide \(M212287EN\)](#).

6.8 Signal damping

You can apply signal damping to diminish the influence of process noise. Damping is applied to the concentration value, and therefore the output signal, of the selected refractometer.

You can select the type of signal damping in **Menu > <your refractometer> > Damping**.

There are 3 types of signal damping:

- Exponential signal damping
- Linear signal damping
- Slew rate

6.8.1 Exponential damping

Exponential damping works for most processes and is the standard choice for slow and continuous processes. The factory setting is always exponential damping.

Select **Damping type** to switch between different damping algorithms.

In the exponential damping, the damping time is the time it takes for the concentration measurement to reach half of its final value at a step change. For example, if the concentration changes from 50 % to 60 % and damping time is 10 s, it takes 10 s for the Indigo520 to display concentration 55 %. A damping time of 5–15 s works best in most cases, the factory setting is 5 s.

Select **Damping time** to set the damping time.

The following figure shows how exponential damping time affects the measurement.

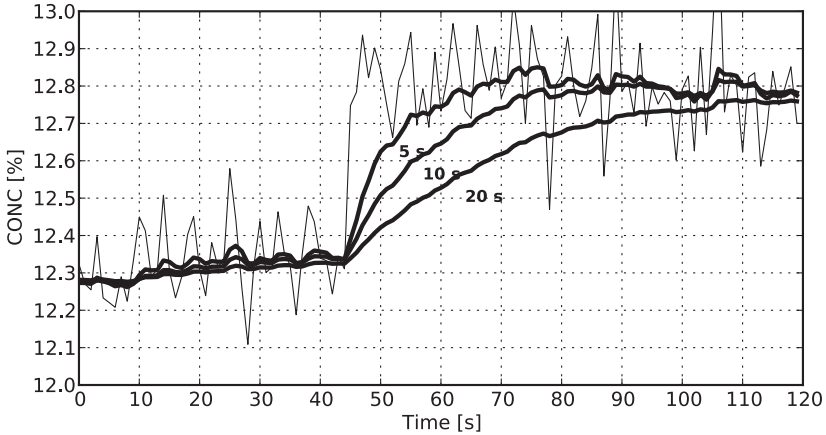

Figure 13 Exponential damping

6.8.2 Linear damping

If the process has fast step changes, linear (fast) damping gives shorter settling time.

In the linear damping, the output is the running average of the signal during the damping time. After a step change the signal rises linearly and reaches the final value after the damping time. The linear damping gives the best trade-off between random noise suppression and step change response time.

Select **Damping time** to set the damping time.



For similar noise suppression, you have to specify a longer damping time than for exponential damping.

The following figure shows how linear damping time affects the measurement.

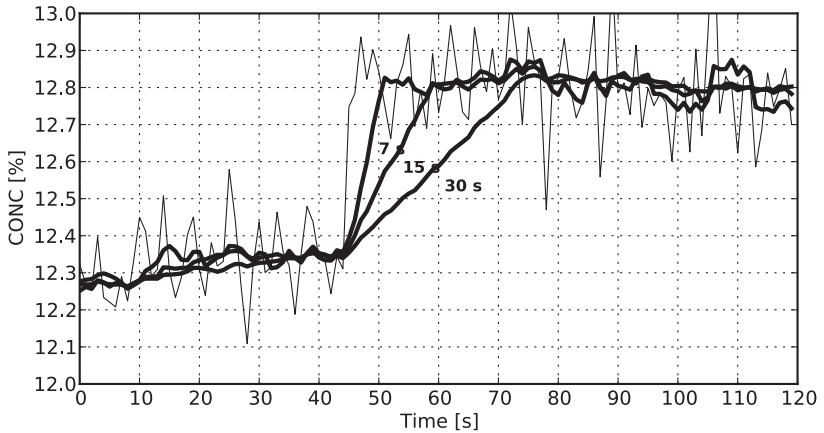

Figure 14 Linear damping

6.8.3 Slew rate limit

If the process signal has short erroneous high or low peaks, the slew rate limiting can be used to cut their effects.

The slew rate damping limits the maximum change for the output signal in 1 s. The slew rate limit damping is recommended for random noise suppression as it is non-linear.

Select **Slew rate** to set the slew rate limit. Typical values depend on the concentration unit but are typically 0.05 % to 1% when the concentration is measured in %.

The following figure gives an example of different slew rate limits.

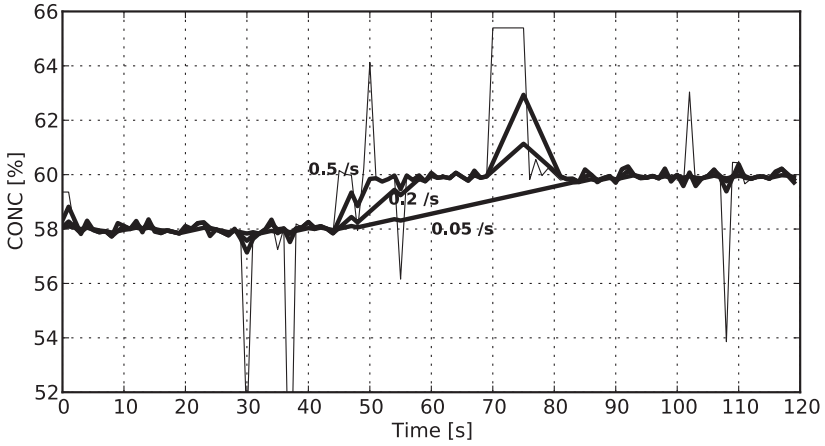

Figure 15 Slew rate damping



To avoid overdamping, do not make the signal insensitive.

7. Using refractometer with Vaisala Insight software

7.1 Insight PC software

With Vaisala Insight PC software, you can:

- Configure analog output channel
- Configure signal damping
- Adjust concentration curves
- Calibrate the RI measurement
- Reset factory RI adjustment parameters

Advanced mode features:

- Adjusting the RI measurement
- Creating blank image
- Overwriting factory RI adjustment parameters



Insight is the only tool to adjust the RI and analog output channel of the refractometer.

7.2 Connecting to Insight software



CAUTION! When connecting several devices at the same time, note that your computer may not be able to supply enough power through its USB ports. Use an externally powered USB hub that can supply >2 W for each port.

Insight can be coupled with 6 devices. The refractometer can be powered through USB, but an external power source can also be used.



Insight is meant for configuring a standalone refractometer. If you have Indigo520 connected to the refractometer, disconnect it before connecting to Insight.

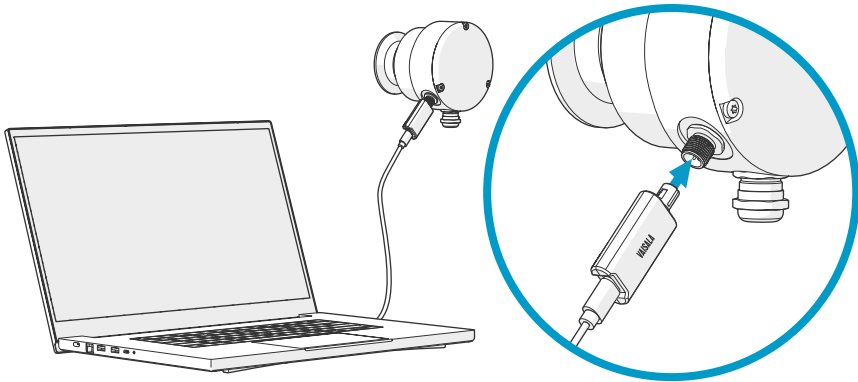



Figure 16 Connecting refractometer to Insight

- ▶ 1. Open the Insight software on your PC.
- 2. Connect the USB cable to a free USB port on the PC.

7.3 Insight main view

The screenshot shows the Vaisala Insight software interface. The top bar includes the Vaisala logo and navigation links: 'Devices', 'Product documentation portal', 'MyVaisala', 'Online store', and 'Settings' (2). The left sidebar has 'Devices' (4) and 'Monitoring' (3) sections. The main content area displays data for device 'PR53 PRO4.002': 'Sugar concentration' is 90.37 °Bx and 'Process Temperature' is 23.71 °C. Below these are two line graphs showing historical data. At the bottom, a summary bar shows 'Raw Concentration Quality Factor' (75.31 °Bx, 41) and 'Refractive Index' (1.477737). A settings menu (1) is open, listing options: 'Basic mode' (checked), 'Advanced mode', 'Metric' (checked), 'Non-metric', 'Unit settings', 'Factory code', and 'About device'. A gear icon (2) is also present.

- 1 Select  to access the device-specific menu.
 - **Configure device:** environmental compensation settings, analog output 1 and 2 settings, filtering factor and general settings.
 - **Export settings:** creates a text file export of the device settings.
 - **Calibrate:** options for calibrating and adjusting RI and T output, testing and adjusting current (analog) output levels, and restoring factory adjustments.
 - **Communication:** contains a quick access selection for restarting the device.
 - **Factory default settings:** restores the device back to default settings, clears any user adjustments and restores the latest factory calibration.
 - **About device:** general device information such as serial number and software version.
- 2 Select **Settings** to switch between the **Basic mode** and **Advanced mode** user modes, change the units of parameters (metric/non-metric), enter a factory code to access restricted functionality, or view information about the Insight software.
- 3 **Monitoring** provides options for monitoring and recording selected parameters, and exporting the monitoring data as a CSV (comma-separated values) file.
- 4 Device information menu with the following tabs:
 - **Measurements:** measurement graph view with parameter drop-down selection.
 - **Calibration information:** read-only information about the latest stored calibration.
 - **Diagnostics:** troubleshooting and administrative information about the device status.

7.3.1 Basic and Advanced user modes

You can switch between the **Basic mode** and **Advanced mode** user modes in the **Settings** menu.

Depending on the connected device, switching to **Advanced mode** may provide access to additional configuration options. Use these options only as described in the product documentation or as instructed by Vaisala support.

7.4 Concentration measurement

Adjustment of the raw concentration value may be required to compensate for some process conditions or to fit the measurement to the laboratory results.

There are four presets that each have their own C and F parameters that can be stored in their memory slots.

7.4.1 Overview of concentration measurement

The concentration measurement is organized in 6 layers.

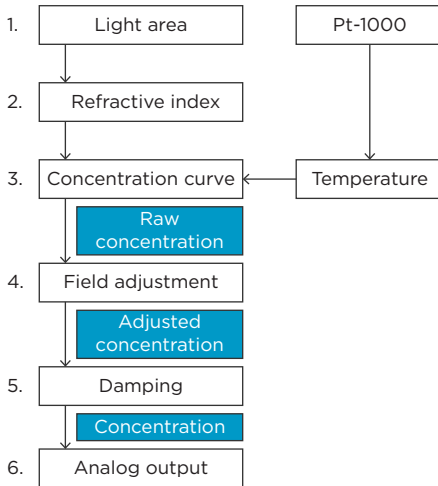

Figure 17 Concentration measurement layers

- 1 Light area information comes from the CCD element and temperature information from Pt-1000 temperature element. The position of the shadow edge is light area and scaled 0–100 %.
- 2 RI adjustment: The actual refractive index RI is calculated from the light area. The temperature is calculated from the Pt-1000 resistance. The RI measurement of each refractometer can be verified using standard nominal reference liquids.
- 3 Concentration curve: The refractometer calculates raw concentration from RI and temperature according to the chemical curve. The result is a temperature-compensated raw concentration value.
- 4 Field adjustment: Adjustment of the raw concentration value may be required to compensate for some process conditions or to fit the measurement to the laboratory results. The field adjustment parameters are used to convert raw concentration into adjusted concentration. The adjusted concentration is called concentration. If there is no adjustment, raw concentration and adjusted concentration are equal.
- 5 Damping: You can apply signal damping to diminish the influence of process noise.
- 6 Output signal: The range of the 4–20 mA signal is defined by its 2 endpoints on the concentration scale.

More information

- [Principle of measurement \(page 98\)](#)

7.4.2 Concentration curve

Concentration curve consists of:

- Actual concentration curve parameters (C-parameters, engineering unit, valid temperature and concentration ranges)

- Related field adjustment parameters (F-parameters)
- Alias name

7.4.2.1 Concentration curve parameters

Concentration curve is the theoretical concentration curve based on RI and temperature. It is defined by a set of 16 parameters, C-parameters.

A concentration curve is specific to the given process medium, for example, sucrose or sodium hydroxide. The set of parameters is given by Vaisala. Do not alter the C-parameters, except if you are changing to another process medium.

There are 4 parallel concentration curves in the refractometer internal memory. They can be changed via Indigo520, Insight or Modbus.



The primary method for correcting the concentration measurement is field adjustment. However, in some cases the linear field adjustment may not be enough and the C-parameters may require fine-tuning. In this case, please contact Vaisala helpdesk for support. Concentration curve contains also other information besides the C-parameters (for example, measurement unit, valid concentration and temperature ranges, and similar).

Table 6 C-parameters

C ₀₀	C ₀₁	C ₀₂	C ₀₃
C ₁₀	C ₁₁	C ₁₂	C ₁₃
C ₂₀	C ₂₁	C ₂₂	C ₂₃
C ₃₀	C ₃₁	C ₃₂	C ₃₃

More information

- [Field adjustment parameters \(page 31\)](#)
- [Changing concentration curves \(page 33\)](#)

7.4.2.2 Field adjustment parameters

Field adjustment can be calculated with the following pattern: **Adjusted concentration = Raw concentration × Field gain + Field offset**

Each concentration curve has its own field adjustment. If you change the concentration curve, field adjustment is no longer the same.

To edit the field gain and field offset,

1. Go to  > **Configure device**.
2. Select the concentration curve you want to modify.
3. Scroll to the end of the screen to modify the **Field gain** and **Field offset**.

To check which concentration curve is active, see [Changing concentration curves \(page 48\)](#).

Accurate adjustment is achieved only if the sample is taken correctly. Pay special attention to following details:

- Field adjustment using the process liquid must always be made inline.
- The sampling valve and the refractometer should be installed close to each other in the process.



WARNING! Wear protective clothing appropriate to your process when operating the sampling valve and handling the sample.

- Run the sample before starting to collect data points to avoid sampling old process liquid that has remained in the sampling valve.
- Read the raw concentration value at exactly the same time with sampling. The easiest way of doing this is to use the Field sample feature, see [Field sample \(page 50\)](#). The value of each sample is the average of 10 consequent measurements to increase accuracy and reduce possible process noise.
- Use a tight container for the sample to avoid evaporation.



Offline adjustment using process liquid very seldom gives reliable results, as problems are caused by:

- Low flow which makes sample to form an unrepresentative film on the prism.
- Sample evaporation at high temperature or undissolved solids at low temperature giving deviations from laboratory determinations.
- An aging sample which is not representative.
- Outside light reaching the prism.

More information

- [Changing concentration curves \(page 48\)](#)
- [Field sample \(page 50\)](#)

7.4.2.3 Calculating field adjustment

To calculate field gain and field offset, you need to take samples from the process liquid.

1. Take samples from the process liquid and take a field sample.
2. Repeat many enough times.

To calculate offset and gain you need at least two points. Take samples from process conditions with a wide span in the measurement range.

3. Calculate field gain and field offset from the data points.

4. Type the values to **Field gain** and **Field offset**.



If there is already a previous field calibration, before calculating the offset and gain values for a new field calibration, reset the values as follows:

- **Field offset:** 0
- **Field gain:** 1

More information

- [Field sample \(page 50\)](#)

7.4.2.4 Managing concentration curves

There are 3 different cases in which you may need to change the concentration curve:

- Switching active concentration curve to another curve that has been configured in the refractometer. For example, switching between Brix, Oeschle, NaOH. This can be done using Indigo520, Insight, Modbus RTU, or Indigo80.
- Changing a preconfigured concentration curve or adding a completely new curve. For example, changing from Brix 0–100 °Bx to NaOH 0–50 g/l. This is done by using the Insight software.
- Finetuning the C-parameters of a preconfigured concentration curve. This can be done by using Indigo520 or Insight.

More information

- [Uploading concentration curves \(page 49\)](#)

7.4.2.5 Changing concentration curves

The PR53 refractometer is able to hold up to 4 concentration curves in its memory. By default, the unit is delivered with one concentration curve pre-configured at the factory as ordered. Additional concentration curves can be added using the Insight software and a USB adapter. Multiple concentration curves pre-configured at the factory are available as a tailored order.

Do not alter the concentration curve parameters, except in case of changing to another process medium. If you are unsure what to do, contact helpdesk@vaisala.com.

A concentration curve is specific to the given process medium, for example, sucrose or sodium hydroxide. The set of parameters is given by Vaisala. Do not alter the concentration curve parameters, except if you are changing to another process medium.

- ▶ 1. You can select the concentration curve in  > **Configure device** > **Active concentration curve** > **Select curve**.

2. You can change the C parameters in  > **Configure device > Concentration curve 1/2/3/4.**

Changing from one concentration curve to another changes the way concentration is calculated from monitored liquids. The refractometer will restart to apply the change.



If any concentration limit warnings have been set, they may be triggered by the change.

More information

- [Field adjustment parameters \(page 46\)](#)

7.4.2.6 Uploading concentration curves

Upload concentration curves if you need to restore original concentration curves, add new previously not configured concentration curves, or take into use updated concentration curves.

- ▶ 1. Log into [MyVaisala.com](https://myvaisala.com) and go to **LM Calibration tools > Concentration models POLARIS PR53**. If you do not have access to the tools, contact your local distributor for the curve data strings.
2. Use the search function to find the correct concentration curve.
3. Select the concentration curve from the list to view its details.
4. Select **Copy to clipboard** to copy the curve data string.
The curve data string is copied to your clipboard.
5. In Insight, go to  > **Configure device > Concentration curve upload**.
6. Select a target concentration curve from the **Target curve** drop down menu. You can either overwrite one of the existing concentration curves or select **Add a new curve**. You can add a maximum of 4 concentration curves.
7. Paste curve data string into the **Curve data string** field.
8. Accept the change by selecting **Save**.

It takes 10–15s to save the changes. The refractometer may restart.



If you are replacing an active concentration curve, the new curve is automatically taken into use. See [Changing concentration curves \(page 48\)](#) for activating concentration curves.

7.4.2.7 Field calibration service

Vaisala provides a field calibration service that adapts the calibration to the factory laboratory determinations based on the data supplied. The field calibration procedure should be made under normal process conditions using standard laboratory determinations of sample concentration.

Email the data to your local Vaisala representative. Vaisala makes a computer analysis of the data and sends optimal calibration parameters to be entered into the Indigo520 transmitter or Insight PC software.

Record the calibrating data in **Configure device > Concentration curve N > Field offset** and **Field gain**. For a complete report, 10–15 valid data points (see below) are needed. A data point is of use for calibration only when there are no active errors or warnings. If prism wash is employed, do not take samples during the wash. Each data point consists of:

- LAB%: Sample concentration determined by the user.
- Raw concentration value: Calculated concentration value.

In addition to the calibration data, write down the refractometer serial number.

7.4.3 Field sample

A field sample is a measurement taken from the process that has the calculated average of 10 consequent measurements. A field sample is usually taken when a snapshot of the process condition is needed.

To take a field sample, select the refractometer > **Diagnostics > Field sample**.

7.5 RI calibration

RI calibration ensures that the measurement of the refractometer is accurate.

The refractometer comes with a calibration certificate which ensures that it has fulfilled the measurement criteria when sent from the factory. RI calibration is needed when the optics of the device is serviced and RI adjustment needs to be performed.

Calibration is done to find out if there is measurement error in the device in the defined measurement area; adjustment is performed to fix the error.



RI adjustment can only be performed with Insight.

In order to perform RI calibration, you need:

- Indigo520 transmitter or Vaisala Insight software
- Sample holder
- Cleaning solution
- Tissues
- Nominal reference RI liquids, see below
- Protective clothing

- Environment with a good ventilation

Nominal reference RI liquids

There are two prism types, each of which have their own nominal reference RI liquid sets. You can check which prism your refractometer has from the configuration code by the side of the refractometer.

- H72
- H73



CAUTION! Each liquid has their own safety instructions with them. Read the instructions carefully before you start RI calibration.

7.5.1 Preparing RI calibration

Before you begin RI calibration, you must perform preparatory actions.

- ▶ 1. Remove the refractometer from the process and place it on a table, prism pointing upwards.
2. Clean the prism and the sample holder with ethanol cleaning solution. Make sure by looking closely that the prism is clean.
3. Mount the sample holder on the prism.
4. Prepare the necessary refractive index reference liquids and de-ionized water (sample liquids) and place them near the refractometer.
5. Let the refractometer and sample liquid temperature settle to room temperature, +20 ... +30 °C (+68 ... +86 °F). Calibration must be done within this temperature range.



The cooling of the refractometer may take several hours.

7.5.2 Performing RI calibration with Insight

- ▶ 1. Select the refractometer.
2. Select  > **Calibrate**.
3. If you want to enter Calibration mode, select **Yes**.



When in calibration mode, concentration calculation is paused and analog output 1 returns to error output level.

4. Select the **RI calibration** menu.

5. Apply sample liquid onto the sample holder and place the light cover on top.



Do not hold the refractometer or sample liquid container in your hand or near external heat sources during calibration. Changes in the refractometer or sample liquid temperature may decrease the quality of the measurement point or cause it to fail.

6. From the available points, starting with Measure, point 1, press **Measure, point 1**.

Calibration of a point may take a few minutes. The calibration progress can be seen at the top half of the screen.

Before calibration, the refractometer waits for the measurement to stabilize and then proceeds to calibrate.

7. Select the used reference sample liquid for the available points, starting with **Nominal RI, point 1**.

After nominal RI is selected, the refractometer calculates the correct reference RI at the measured temperature. It is not recommended to modify the reference RI value.

8. View the calibration results below in the result block.
9. Repeat the process for other available points as needed.

The result block shows the difference between reference value and measured value, some diagnostic values, and the status of a single calibration point.

Status of the available points, starting with **Status, point 1**, tells if the calibration was within specified accuracy limits.



If you need to recalibrate one or more of the calibration points,

1. Select **None** for Nominal RI.
2. Press **Measure point** for the selected point.
3. Reselect the wanted Nominal RI for the selected point.

7.5.3 Completing RI calibration

- ▶ 1. Once all necessary points have been calibrated, press **Store calibration** at the bottom of the register list. Pressing this button completes the calibration and stores current calibration results in the refractometer memory.



You can only access the most recent calibration result. Older results are not stored.

7.6 RI adjustment

Each refractometer has their own unique RI adjustment curve that has been calculated at the Vaisala factory. These are the A parameters.



Only trained personnel should perform RI adjustment as a service procedure. Adjusting how the refractive index is calculated changes the way concentration is measured. If adjustment is done wrong, the refractometer can start measuring concentration incorrectly.

In order to perform RI calculation adjustment, you need to calibrate at least five calibration points that all have a different Nominal RI. You can do this in the **RI calibration** menu. Vaisala recommends that you perform RI adjustment based on a recent calibration.

- ▶ 1. Perform RI calibration in the **RI calibration** menu. Alternatively, retrieve calibration data from a previously stored calibration by selecting **Retrieve stored calibration**.
2. Verify from the retrieved calibration date that the RI calibration data is available and recent.
3. Select **Start adjustment**.

Refractometer calculates new RI calculation parameters. New parameters and maximum difference are shown on the top half of the screen.

Maximum difference is the greatest refractive index difference value calculated from the available calibration points when using new RI calculation parameters.

4. If you are satisfied with the new RI calculation parameters and maximum difference result, select **Yes**.

The new calculation parameters are applied immediately. The refractometer reboots after the new parameters are applied.

7.6.1 Overwriting factory adjustment

Overwrite factory adjustment after optical components have been serviced.

- ▶ 1. Select **Overwrite factory adjustment**.

If this is not done and the refractometer factory settings are restored, the refractometer may fail to calculate concentration accurately.

7.7 Temperature adjustment

The reference value needs to be known.

Temperature adjustment does not affect concentration calculations.

- ▶ 1. Go to  > **Calibrate device**.
2. Insert your device in the reference environment for the first calibration point.

3. Wait for the measurement to stabilize fully. The graph shows readings of the last 60 minutes.
4. When the measurement has stabilized, select the **Reference value, point 1** text box and enter the temperature of calibration point 1. Select **ENTER** or click outside the field when done.
5. Check that the measured value for point 1 is automatically inserted.
6. Check the difference between each reference and measured value. Very large differences may be due to insufficient stabilization time or unsuitable calibration setup.

If you want to adjust the device, select **Activate adjustment** and verify the result from the message that appears at the top of the screen..
To exit without taking the adjustment in use, select **Close**.
7. After calibrating your device, update the information in the **Calibration information** tab.

7.7.1 Adjusting temperature using previously measured value

If the device allows the field for measured value to be edited and you have a list of previously collected calibration readings (for example, from a third party laboratory calibration), you can adjust the device without having to generate the calibration conditions and wait for stabilization.

- ▶ 1. Select the **Reference value, point 1** field and enter the temperature of calibration point 1. Press **ENTER** or click outside the field when done.
2. Replace the automatically inserted measured value for point 1 with your previously measured value.
3. Repeat the procedure for all desired calibration points.
4. Select **Activate adjustment** and verify the result from the message that appears at the top of the screen.

7.8 Blank image

Blank image is a reference image that has been taken when there is no sample on the prism. It is used for normalizing the optical image for image detection and diagnostics.

Blank image is used when the chosen detection algorithm is IDS algorithm. The edge detection of this algorithm is based on the analysis of the normalized optical image. The changes caused by the sample and prism erosion are more easily detected in a normalized image. See the "no sample" image in [Analyzing optical image \(page 100\)](#). When there is no sample on the prism, this is the desired optical image.

There are three possible statuses for blank image:

- **OK:** The blank image is usable.
- **Checksum error:** No valid image available. Create a new blank image or restore factory image by pressing **Restore factory image**.

- **Not applicable:** Appears only if VD algorithm is used as detection algorithm.

More information

- [Creating blank image \(page 55\)](#)

7.8.1 Creating blank image



This is a maintenance operation only.

The procedure should only be done if the prism has been replaced, for example.

To create a blank image,

- ▶ 1. Remove the refractometer from the process line.
2. Clean the prism with ethanol cleaning solution.
3. Protect the prism from outside light.
4. Select **Create image**.

More information

- [Blank image \(page 54\)](#)

7.9 Configuring analog output

The PR53 process refractometer has one built-in 4–20 mA output.

For the electrical properties of the analog output, see [Refractometer connections \(page 17\)](#).

To configure the analog output, go to  > **Configure device > Analog output 1**.

To adjust the analog output:

- **Scale low end** sets the value when the signal is 4 mA. The default zero value is 0.00, the unit depends on the source and display unit set for the sensor in question (and can thus be for example 0 Bx or 0 °F).
- **Scale high end** sets the range, which is the value given when the signal is 20 mA.
- **Error output level** sets an analog default output value that the instrument returns to in certain malfunction situations. The factory setting for default output is 3.4 mA. For a list of malfunctions that are affected, see [Diagnostic message priorities \(page 68\)](#).
 - NAMUR NE 43 uses the 3.8–20.5 mA signal range for measurement information. With PR53 process refractometers, you can configure ≤ 3.6 mA to indicate diagnostic failures. With that information, it is easier to detect a failure condition on a refractometer, for example, it clearly tells you whether you have an empty pipe or a failed instrument.

- **No sample error output** and **No sample error output level** allow you to set a secondary mA output value for empty pipe (message **No liquid detected**) to differentiate it from the other messages that cause the measurement to revert to default mA. By default the secondary mA output is disabled.

More information

- [Refractometer connections \(page 17\)](#)
- [Adjusting output level for analog output 1 \(page 56\)](#)
- [Diagnostic message priorities \(page 68\)](#)

7.9.1 Adjusting output level for analog output 1

In test mode, you can test the current output level of the analog output with a multimeter, and adjust the output level (2-point adjustment) if necessary.



Always switch **Test mode** off after testing to return the analog outputs to normal operating mode. The analog output does not output measurement data when analog outputs are in test mode.

To test and adjust the current output level of the analog output:

- ▶ 1. Connect a multimeter to the analog output wiring (connect in series to measure the current output).
2. Go to > **Calibrate** > **Yes**.
3. Enable the **Test mode** (switch to **ON** position).



Selecting **Disabled** turns off the selected output.

4. Enter a low output value in mA (for example, **5**) in the **Test output level** field. The analog output starts to output current at this level.
5. Check the multimeter reading and enter the measured value (for example, **4.95**) in the **Measured value, low point** field.
6. Enter a high mA value (for example, **19**) in the **Test output level** field, check the multimeter reading, and enter the value of the multimeter reading to the **Measured value, high point** field if it differs from the test output value.
7. Select **Activate adjustment** to save the correction to the output level.
8. To verify that the current level of the output is now accurate, enter a new value (for example, **12**) in the **Test output level** field and check that the multimeter reading matches the test output value you entered.
9. Record the gain and offset values for later use: you can enter the gain and offset directly to achieve the same adjustment later.

10. Disable the **Test mode** (switch to **OFF** position) and select **Close** to exit the calibration mode.
11. Replace the original analog output wiring.

7.9.2 Configuring analog output signal damping

You can apply signal damping in  > **Configure device** > **Damping** to diminish the influence of process noise. Damping is applied to the concentration value (and therefore the output signal) of the selected refractometer.

There are 3 types of signal damping:

- Exponential signal damping
- Linear signal damping
- Slew rate

You can select the type of signal damping in **Damping type**.

You can edit the following:

- **Damping time**
- **Tolerance time**
- **Slew rate**

7.9.2.1 Exponential damping

Exponential (standard) damping works for most processes and is the standard choice for slow and continuous processes. The factory setting is always exponential damping.

Select **Damping type** to switch between different damping algorithms.

In the exponential damping, the damping time is the time it takes for the concentration measurement to reach half of its final value at a step change. For example, if the concentration changes from 50 % to 60 % and damping time is 10 s, it takes 10 s for Insight to display concentration 55 %. A damping time of 5–15 s works best in most cases, the factory setting is 5 s. Use the **Damping time** menu item to set the damping time.

The following figure shows how exponential damping time affects the measurement.

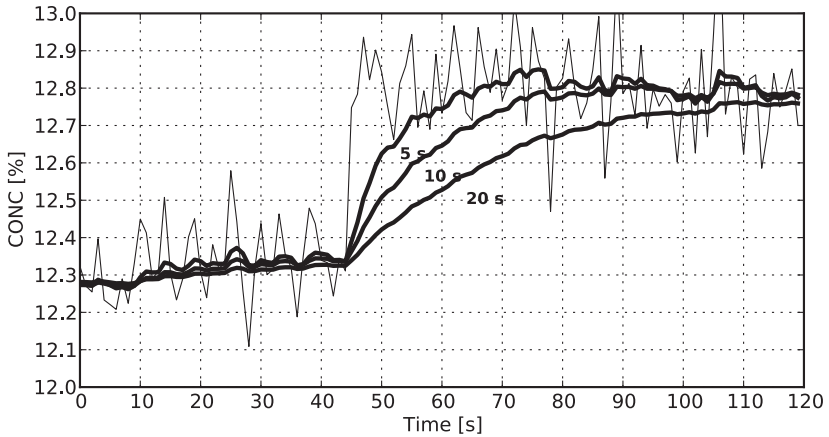

Figure 18 Exponential damping

7.9.2.2 Linear damping

If the process has fast step changes, linear (fast) damping gives shorter settling time.

In the linear damping, the output is the running average of the signal during the damping time. After a step change the signal rises linearly and reaches the final value after the damping time. The linear damping gives the best trade-off between random noise suppression and step change response time.

Select **Damping time** to set the damping time.



For similar noise suppression a longer damping time has to be specified than for the exponential damping.

The following figure shows how linear damping time affects the measurement.

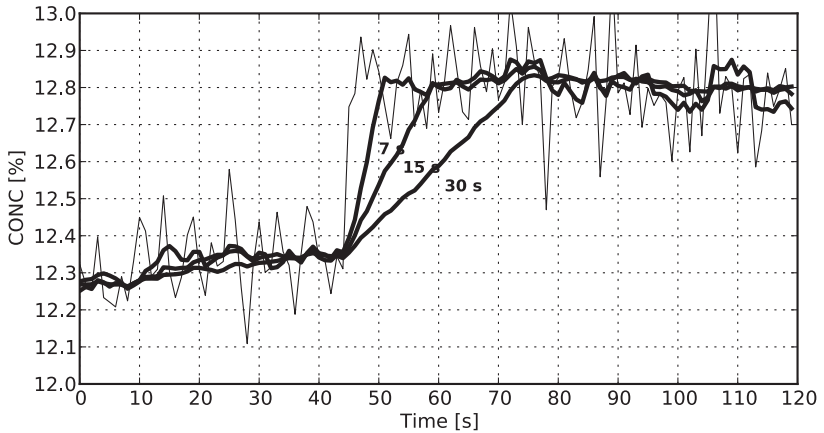

Figure 19 Linear damping

7.9.2.3 Slew rate limit

If the process signal has short erroneous high or low peaks, the slew rate limiting can be used to cut their effects.

The slew rate damping limits the maximum change for the output signal in 1 s. The slew rate limit damping is recommended for random noise suppression as it is non-linear.

Select **Slew rate** to set the slew rate limit. Typical values depend on the concentration unit but are typically 0.05 % to 1 % when the concentration is measured in %.

The following figure gives an example of different slew rate limits.

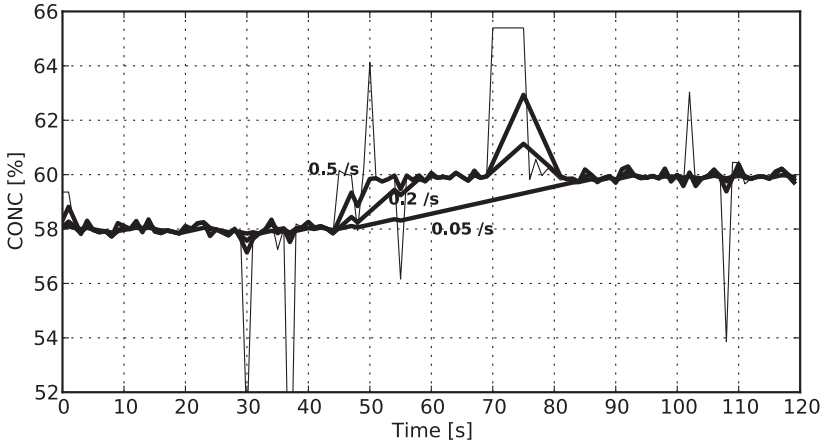

Figure 20 Slew rate damping



To avoid overdamping, do not make the signal insensitive.

7.10 Configuring Modbus communication settings with Insight

You can configure the following Modbus communication settings with the Insight PC software:

- Device address
- Communication bit rate
- Parity, data bits, and stop bits
- Response delay

To configure the Modbus communication settings with Insight:

- ▶ 1. Connect to Insight and select **⚙ > Configure device > Communication**.
2. Enter the communication values as needed: see the instructions in the Insight interface for allowed ranges and additional information.

3. Select **Save** to store the settings.

More information

- [Modbus RTU \(page 24\)](#)
- [Modbus registers \(page 88\)](#)
- [System wiring \(page 18\)](#)
- [Starting up stand-alone refractometer \(page 26\)](#)

7.11 Restoring factory settings

The **Restore default settings** function restores the refractometer to the latest saved settings and parameters. Restoring factory settings does not restore the concentration curves.

- ▶ 1. Select **Factory default settings > Restore default settings > Yes**.

More information

- [Uploading concentration curves \(page 49\)](#)

8. Preventive maintenance

8.1 Preventive maintenance

PR53 process refractometers do not have wearing parts or periodically changeable parts. Depending on the process conditions, PR53 process refractometers may never need to be serviced.

There are a few things that should be monitored:

Table 7 Preventive maintenance

Part	Action
Prism	<p>Make sure that the prism is clean by monitoring the following:</p> <ul style="list-style-type: none"> • Optical image diagnostics. See Analyzing optical image (page 100). • Change in the Quality Factor value. Change in the value usually indicates that the prism is dirty. See Vaisala Polaris Process Refractometer PR53 Prism Wash System User Guide.
Prism gasket	<p>Visually check that the prism gasket is intact. This is especially important with the hygienic devices' wetted parts.</p>
Refractometer's internal humidity level	<p>Relative humidity indicates if any liquid has leaked inside the refractometer or if the internal drying capsule needs replacement. Typically the internal relative humidity should be < 50 %RH.</p>

8.2 Cleaning refractometer and prism

Cleaning the prism

In most applications the prism stays clean due to its self-cleaning effect.

In case of a coating problem, the preferred solution is to try to increase the flow velocity, for example by installing a pipe portion with smaller diameter. Installing a wash nozzle and a wash system can be considered, if increasing the velocity does not provide a solution. See [PR53 Prism Wash System User Guide \(M212808EN\)](#).

If the prism needs mechanical cleaning, clean it gently using a suitable solvent. Dry it gently using a lint-free cloth, such as a microfiber cloth.

Cleaning the refractometer

Clean the refractometer by using a suitable solvent and a moist cloth.

9. Troubleshooting

9.1 Troubleshooting messages

Table 8 Hardware troubleshooting

Problem	Severity level	Cause	Corrective action
Message Internal humidity too high	Error	The relative humidity measured at the refractometer's processor card exceeds 60 %RH. The reason may be moisture leaking in through the prism seal or the cover being open.	Make sure that the prism seal is intact and the cover is closed. If necessary, replace the prism seal.
Message Internal temperature too high	Error	The temperature on the sensor processor card exceeds +65 °C (+150 °F). To read this temperature, <ul style="list-style-type: none"> in Indigo520, go to Menu > <your refractometer> > Diagnostics. in Insight, go to <your refractometer> > Diagnostics . 	Make sure you are using the device in the right temperature. See the ambient and process temperature in the model-specific specifications.
Indigo520: No devices connected / Disconnected Insight: No connected devices in the start screen	n/a	The cables are not properly connected. The refractometer is connected to both Indigo520 and Insight.	Make sure that cables are properly connected at both ends. If the refractometer is connected to both Indigo520 and Insight, it prioritizes Indigo520 and is not visible to Insight. If you are able to open the refractometer cover, make sure that the green LED is on. This means that the refractometer is powered.
Relays not working	n/a	Relays may be in test mode. Make sure using Indigo520 that the test mode is inactive in Menu > Inputs and outputs > Relays > Test mode. For testing the wash function, see PR53 Prism Wash System User Guide (M212808EN) .	

Problem	Severity level	Cause	Corrective action
Analog output signal is not working as expected	n/a	<p>Check wiring, see the model-specific installation guide.</p> <p>If the analog output signal does not correspond to the concentration display, check output signal configuration, see Diagnostics.</p> <p>For possible correction, configure the analog output.</p> <ul style="list-style-type: none"> Indigo520: See Indigo500 User Guide (M212287EN). Insight: See Configuring analog output (page 55). <p>A low analog output signal can also be caused by high resistance in the external current loop, see Refractometer connections (page 17).</p> <p>A noisy signal can be damped, see</p> <ul style="list-style-type: none"> Indigo520: Signal damping (page 37) Insight: Configuring analog output signal damping (page 57) 	

Table 9 Measurement troubleshooting

Problem	Severity level	Cause	Corrective action
Message No optical image	Critical	<p>To see the optical image, on your Indigo520, go to Menu > <your refractometer> > Diagnostics. There are several possible causes:</p> <ol style="list-style-type: none"> The prism is heavily coated. Perform prism wash if available, see PR53 Prism Wash System User Guide (M212808EN). If the prism wash is not available, remove the refractometer from process line and clean the prism manually. There is moisture condensation in the refractometer head. The refractometer head temperature is too high. The light source is faulty. When the refractometer is removed from the process, a yellow flashing light can be seen through the prism. 	
			<div style="background-color: #f0f0f0; padding: 10px; border: 1px solid #ccc;"> <p> The light is only visible at an oblique angle. Also check the LED value in the Diagnostics view; if the value is clearly below 100, LED fault is not likely.</p> </div> <ol style="list-style-type: none"> There are negative spikes in the optical image. The probable cause is dust or fingerprints on the optical element. The CCD card in the refractometer is faulty.

Problem	Severity level	Cause	Corrective action
Message Blank image corrupted	Critical	Blank image is missing or corrupted.	A trained person can create a blank image. Contact helpdesk@vaisala.com .
Message External light level too high	Error	The measurement is not possible because too much outside light reaches the camera.	Identify the light source (for example sun shining into an open tank or a translucent pipe) and block the light from getting to the prism at the sensor tip.
Message Prism coating detected	Error	The optical surface of the prism is coated by the process medium or impurities in the process medium.	Perform prism wash if available, see PR53 Prism Wash System User Guide (M212808EN) . If prism wash is not available, remove the refractometer from process line and clean prism manually. If the problem is recurrent, consider improving the flow conditions, see model-specific installation guide. If prism wash is available, adjust the wash parameters, see PR53 Prism Wash System User Guide (M212808EN) .
Message Temperature measurement error	Error	A temperature element is faulty.	Replace the temperature element. Note that a difference to some other process temperature measurement is not a fault. PR53 measures the true temperature of the prism surface.
Message Invalid calculation parameters	Error	The A parameters are incorrect.	Perform RI adjustment or contact helpdesk@vaisala.com .

Problem	Severity level	Cause	Corrective action
Message C measurement out of concentration curve range	Warning	Concentration measurement is outside of the range defined in the concentration curve. If the measurement concentration is other than the valid range for the used curve, the measurement result may be unreliable.	<ol style="list-style-type: none"> 1. Make sure that the measurement is correct. If yes, consider if the used concentration curve is suitable for the process. Contact your sales representative or helpdesk@vaisala.com. 2. If you know that the measurement does not correspond to the true concentration value, the refractometer needs to be serviced. Contact helpdesk@vaisala.com.
Message T measurement out of concentration curve range	Warning	Temperature measurement is outside of the range defined in the concentration curve. If the measurement temperature is other than the valid range for the used curve, the measurement result may be unreliable.	<ol style="list-style-type: none"> 1. Make sure that the measurement is correct. If yes, consider if the used concentration curve is suitable for the process. Contact your sales representative or helpdesk@vaisala.com. 2. If the temperature error is notably big, the refractometer needs to be serviced. Contact helpdesk@vaisala.com.
Message External light level high	Warning	Some light from the outside reaches the sensor and may disturb the measurement.	Identify the light source (for example sun shining into an open tank or a translucent pipe) and block the light from getting to the prism at the sensor tip.
Message Image quality low	Warning	The most likely cause for this message is scaling on the prism. There still is an optical image available, but the measurement quality may not be optimal.	Clean the prism.
Message No liquid detected	Warning	The operation of the equipment is OK but there is no process liquid on the prism.	

Problem	Severity level	Cause	Corrective action
Message Calibration mode active	Warning	When calibration mode is active, the refractometer will not calculate the concentration.	Make sure that the calibration mode is off in all used user interfaces.
Unexpected concentration drift	n/a	For drift upward, suspect prism coating, see PR53 Prism Wash System User Guide (M212808EN) . Otherwise make sure calibration is correct, see RI calibration (page 34) , as well as RI adjustment, see RI adjustment (page 53) . The latter can only be done with Insight.	

9.2 Diagnostic message priorities



The messages are listed in descending order of priority. For example, if both **No optical image** and **Temperature measurement error** are activated, only **No optical image** is displayed.

Certain malfunctions cause the mA measurement to return to the error output level, see [Configuring analog output \(page 55\)](#). For more information, see the following table.

Table 10 Diagnostic message priorities

Message	Error output level
Image quality low	
External light level high	
Prism coating detected	x
No liquid detected	x
No optical image	x
External light level too high	x
Temperature measurement error	x
C measurement out of concentration curve range	
T measurement out of concentration curve range	
Invalid calculation parameters	x
Calibration mode active	x
Internal temperature too high	

Message	Error output level
Internal humidity too high	
Blank image corrupted	

Invalid calculation parameters: RI adjustment parameters are invalid. Perform RI adjustment or contact helpdesk@vaisala.com.

Blank image corrupted: Blank image for IDS image detection algorithm is corrupted. Create blank image or contact helpdesk@vaisala.com.

9.3 Measurement status details

There are different measurement statuses that you can view in the Diagnostics tab of the Insight software.

- C measurement status
- T measurement status
- Field sample status

Table 11 Measurement status details

Message	C measurement status	T measurement status	Field sample status
None	No errors detected.	No errors detected.	No errors detected.
Unavailable (S)	Concentration measurement is unavailable because no liquid is detected on the prism or the device is in calibration mode.	-	No field sample has been taken.
Unreliable (R)	Refractometer is measuring temperature outside concentration curve measurement range. Temperature compensation might not work properly.	-	A warning in image detection has occurred during taking the field sample.
Under range (U)	Refractometer is measuring a value outside concentration curve measurement range.	Refractometer is measuring a value outside concentration curve measurement range.	-

Message	C measurement status	T measurement status	Field sample status
Over range (O)	Refractometer is measuring a value outside concentration curve measurement range.	Refractometer is measuring a value outside concentration curve measurement range.	-
Locked (L)	Concentration value is locked during prism wash.	Temperature value is locked during prism wash.	-
Failure (F)	Optical image is not available. Refractometer needs maintenance, contact helpdesk@vaisala.com .	Temperature sensor has failed. Refractometer needs maintenance, contact helpdesk@vaisala.com .	Optical image is not available or temperature sensor has failed during taking the field sample.
Not ready (W)	-	-	Field sample is being measured and the results are not yet available.

9.4 Calibration check

Wait until normal process conditions occur. The concentration reading is precalibrated at delivery and a copy of the calibration certificate is delivered with the process refractometer. If the diagnostic message is **Normal operation** but the concentration reading does not agree with the laboratory results, see

- Indigo520: [Performing RI calibration with Indigo520 \(page 36\)](#)
- Insight: [Performing RI calibration with Insight \(page 51\)](#).

9.5 RI calibration failure

It is recommended to recalibrate any failed points at least once more. Something external may have caused the calibration failure.

- Temperature related failures:
 - There is a difference between the sample temperature and the refractometer temperature.
 - Measured temperature is out of the specified +20 ... +30 °C (+68 ... +86 °F) calibration range.

If the calibration failure is caused by temperature, both refractometer and sample liquid temperature should be allowed to stabilize to be in the calibration range. Retry calibration after a little while.

- Reference liquid related failures:
 - There is coating on the prism.
Clean the prism and the sample holder, and then recalibrate.
 - There are impurities in the sample liquid.
Clean the prism and the sample holder. Replace the sample liquid and then recalibrate.
 - Reference liquid has expired.
Check the expiration date and use another reference liquid if needed. Notice that the liquids may expire quicker if the containers are left open for extended periods of time.

More information

- [Analyzing optical image \(page 100\)](#)

10. Technical data

10.1 Compatibility

PR53 refractometer is mechanically compatible with most PR-23 and PR-43 refractometers. The communication and electronic system has to be updated with the refractometer change.

10.2 PR53 common specifications

Table 12 Measurement performance

Property	Description/Value
Refractive index	
Measurement range	1.32-1.53 nD (Corresponds to 0-100 °Bx)
Accuracy	± 0.00014 nD (0.1 °Bx) ¹⁾
Repeatability	± 0.00002 nD ²⁾
Resolution	± 0.000015 nD
Response time T ₆₃ with default damping	10 s ³⁾
Measurement cycle	1 / s
Long-term stability	Max. 0.1 % full scale / a
Temperature	
Accuracy at 20 °C (68 °F)	± 0.3 °C (0.54 °F) ¹⁾
Sensor class	F0.15 IEC 60751
Temperature coefficient	± 0.002 °C / C

- 1) Accuracy specified with respect to calibration reference, including non-linearity, hysteresis at +20 °C.
- 2) Repeatability, confidence level k=2, including random noise, at T_a = +20 °C, with standard low-pass filtering.
- 3) With standard low-pass filtering.

Table 13 Inputs and outputs

Property	Specification
Supply	
Operating voltage	24 V DC nominal (9-30 V DC)

Property	Specification
Power consumption	Less than 1 W
Protection class	3, PELV
Outputs	
Output parameters	RI, temperature, concentration, quality factor
Diagnostics	Image detection: outside light error, no optical image, no sample, prism coated, prism coated persistently, outside light to prism, low image quality Process temperature measurement: temperature measurement fault Concentration calculation: concentration out of range, temperature out of range Internal environment: high internal temperature, high internal humidity System: blank image corrupted
Analog outputs	
mA	Sourcing, isolated, NAMUR NE 43, configurable
mA range	3.8–20.5 mA
Loop impedance	Max. 600 Ω
Accuracy of analog outputs at +20 °C	±0.1 % of full scale (±0.00002 RI)
Digital outputs	
Digital output	RS-485, non-isolated
Maximum cable run	300 m (approx. 1000 ft) (digital)
Supported protocol	Modbus RTU
Connectors	
External connectors	1 × M12 F 4 pins, A-coded ¹⁾ 2 × M16×1.5 cable gland, Cable D 5–10 mm / Adapter for conduit entry M16×1.5 / NPT ½"

1) For USB2 adapter and Insight software, see www.vaisala.com/insight.

Table 14 Compliance

Property	Specification
Electromagnetic compatibility (EMC)	EN 61326-1, industrial environment
Safety	IEC/EN/UL 61010-1

Property	Specification
Pressure	CRN all territories, ASME BPVC Sec VIII Div. 1 Ed. 2021
Material compliance	FDA 21 CFR 177.150, 177.2600, 177.1550 EC 1935/2004 EC 2023/2006, GMP EU 10/2011
Compliance marks	CE, China RoHS, RCM, UKCA
Listing marks	MET listed (US and Canada)

10.3 PR53AC specifications

Table 15 Operating environment

Property	Specification
Process parameters	
Process temperature	-40 ... +150 °C (-40 ... +302 °F) ¹⁾
Design temperature	+180 °C (356 °F) ²⁾
Design pressure	40 bar ³⁾
Operating environment	
Storage temperature	-40 ... +65 °C (-40 ... +149 °F)
Operating temperature	-40 ... +60 °C (-40 ... +140 °F)
Maximum operating altitude	2000 m (approx. 6500 ft)
Operating humidity	0-100 %RH
Storage humidity	0-100 %RH, non-condensing
UL 50E (NEMA) rating	Type 4X: Dust-tight. Protected from corrosion and powerful water jets from any direction.
IP rating	IP66: Dust-tight. Protected from powerful water jets from any direction. IP67: Dust-tight. Protected from the effects of temporary immersion in water under standardized conditions of pressure and time.

- 1) -40... +130 °C (-40 ... 266 °F) EPDM gasket, -40... +150 °C (-40 ... +302 °F) PTFE gasket.
- 2) Maximum momentary temperature peak.
- 3) Maximum at +20 °C (68 °F), operating pressure to the clamp rating pressure.

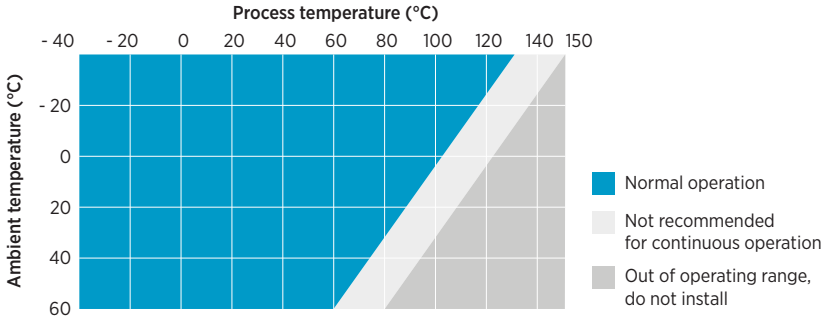

Figure 21 PR53AC process temperature, options Sanitary 2.5" and Type N (indicative)

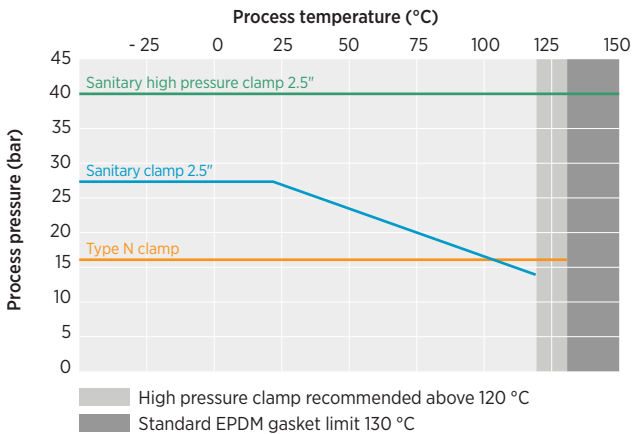

Figure 22 PR53AC process pressure

Table 16 Sanitary compliance

Property	Specification
Hygienic design	3-A 46-04 EHEDG
Compliance marks	3-A, EHEDG (for EHEDG compliant installation, use 2.5" / 4" sanitary gasket)
Biocompatibility	USP Class VI <88>, 70 °C
ADI free (Animal Derived Ingredients)	Yes

Table 17 Mechanical specifications

Property	Specification
Wetted parts	
Sensor head	EN 1.4435 BN2 (AISI 316L) ¹⁾
Surface roughness	Ra 0.8 µm
Prism	Sapphire monocrystalline, 99.996 % Al ₂ O ₃ ²⁾
Prism gasket	Modified PTFE ³⁾
Sanitary 2.5" gasket	EPDM ²⁾
Type N gasket	EPDM ²⁾
Welding ferrule	EN 1.4435 (AISI 316L) ^{1) 4)} ASME BPE-2019 (DIN 32676-C)
Non-wetted parts	
Housing	EN 1.4404 (AISI 316L)
Screws TX20, torque 2.0 Nm	EN 1.4404 (AISI 316L)
Cable gland	EN 1.4305 (AISI 303) HUMMEL 1.693.1600.50
Dummy plug	EN 1.4305 (AISI 303) AGRO 8717.96.08.70
Conduit hub	EN 1.4404 (AISI 316L) Vaisala, DRW257718, M16×1.5 / NPT ½ in
M12 connector	Gland, EN 1.4305 (AISI 303) Contacts, CuZn with Ni/Au plating Phoenix Contact, 1405233, M12/4(M), A, 4×0.34 mm ² , TPE, 0.5 m Carrier, PA 6.6
Sanitary 2.5" clamp	EN 1.4301 (AISI 304) ²⁾
Type N Clamp	EN 1.4301 (AISI 304) ²⁾
Cable	4×22 AWG PUR, gray 10 m multistrand, with ferrules Flame-retardant acc. to IEC 60332-1-2, FT1, VW1
Weight	2.7 kg (5.95 lb)

1) EN 10204 / 3.1 certificate included.

2) Manufacturer's declaration included.

3) ADI free, FDA 21 C.F.R 177.1550, 3A Sanitary Standard, USP Class VI <88>, 70 °C.

4) 3-A certificate, EHEDG certificate.

10.4 PR53AP specifications

Table 18 Operating environment

Property	Specification
Process parameters	
Process temperature	-40 ... +150 °C (-40 ... +302 °F) ¹⁾
Design temperature	+180 °C (356 °F) ²⁾
Design pressure	40 bar ³⁾
Operating environment	
Storage temperature	-40 ... +65 °C (-40 ... +149 °F)
Operating temperature	-40 ... +60 °C (-40 ... +140 °F)
Maximum operating altitude	2000 m (approx. 6500 ft)
Operating humidity	0-100 %RH
Storage humidity	0-100 %RH, non-condensing
UL 50E (NEMA) rating	Type 4X: Dust-tight. Protected from corrosion and powerful water jets from any direction.
IP rating	IP66: Dust-tight. Protected from powerful water jets from any direction. IP67: Dust-tight. Protected from the effects of temporary immersion in water under standardized conditions of pressure and time.

1) -40 ... +130 °C (-40 ... 266 °F) EPDM gasket, -40... +150 °C (-40 ... +302 °F) PTFE gasket

2) Maximum momentary temperature peak.

3) Maximum at +20 °C (68 °F), operating pressure to the clamp rating pressure.

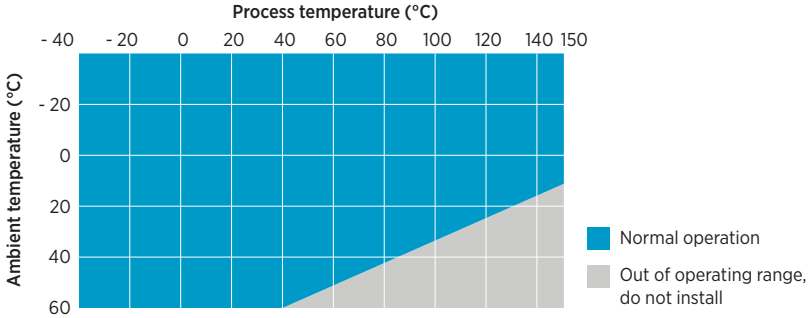

Figure 23 PR53AP process temperature (indicative)

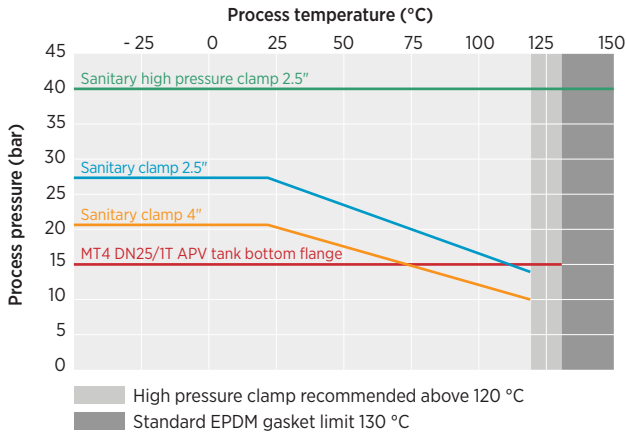

Figure 24 PR53AP process pressure

Table 19 Sanitary compliance

Property	Specification
Hygienic design	3-A 46-04 EHEDG
Compliance marks	3-A, EHEDG (for EHEDG compliant installation, use 2.5" / 4" sanitary gasket)
Biocompatibility	USP Class VI <88>, 70 °C
ADI free (Animal Derived Ingredients)	Yes

Table 20 Mechanical specifications

Property	Specification
Wetted parts	
Sensor head	EN 1.4435 BN2 (AISI 316L) ¹⁾
Wash nozzle	EN 1.4404 (AISI316L) ¹⁾ EPDM gasket ²⁾
Surface roughness	Ra 0.8 µm
Prism	Sapphire monocrystalline, 99.996 % Al ₂ O ₃ ²⁾
Prism gasket	Modified PTFE ³⁾
Sanitary gasket 2.5" / 4"	EPDM ²⁾
Tank bottom gasket MT4 DN25/1T for tank bottom flange	EPDM ²⁾
Tank bottom flange	AISI316L ¹⁾
Welding ferrule	EN 1.4435 (AISI 316L) ^{1) 4)}
Non-wetted parts	
Housing	EN 1.4404 (AISI 316L)
Screws, TX20, torque 2.0 Nm	EN 1.4404 (AISI 316L)
Cable gland	EN 1.4305 (AISI 303) HUMMEL 1.693.1600.50
Dummy plug	EN 1.4305 (AISI 303) AGRO 8717.96.08.70
Conduit hub	EN 1.4404 (AISI 316L) Vaisala, DRW257718, M16×1.5 / NPT ½ in
M12 connector	Gland, EN 1.4305 (AISI 303) Contacts, CuZn with Ni/Au plating Phoenix Contact, 1405233, M12/4(M), A, 4×0.34 mm ² , TPE, 0.5 m Carrier, PA 6.6
Sanitary clamp 2.5" / 4"	EN 1.4301 (AISI 304) ²⁾
Cable	4×22 AWG PUR, black 10 m multistrand, with ferrules Flame-retardant acc. to IEC 60332-1-2, FT1, VW1

Property	Specification
Weight	3.6–4.2 kg (7.94–9.26 lb)

- 1) *Material certificate included.*
- 2) *Manufacturer’s declaration included.*
- 3) *ADI free, FDA 21 C.F.R 177.1550, 3A Sanitary Standard, USP Class VI <88>, 70 °C.*
- 4) *3-A certificate, EHEDG certificate.*

10.5 PR53GC specifications

Table 21 Operating environment

Property	Specification
Process parameters	
Process temperature	–40 ... +150 °C (–40 ... +302 °F)
Design temperature	+180 °C (356 °F) ¹⁾
Operating environment	
Storage temperature	–40 ... +65 °C (–40 ... +149 °F)
Operating temperature	–40 ... +60 °C (–40 ... +140 °F)
Maximum operating altitude	2000 m (approx. 6500 ft)
Operating humidity	0–100 %RH
Storage humidity	0–100 %RH, non-condensing
UL 50E (NEMA) rating	Type 4X: Dust-tight. Protected from corrosion and powerful water jets from any direction.
IP rating	IP66: Dust-tight. Protected from powerful water jets from any direction. IP67: Dust-tight. Protected from the effects of temporary immersion in water under standardized conditions of pressure and time.

1) *Maximum momentary temperature peak.*

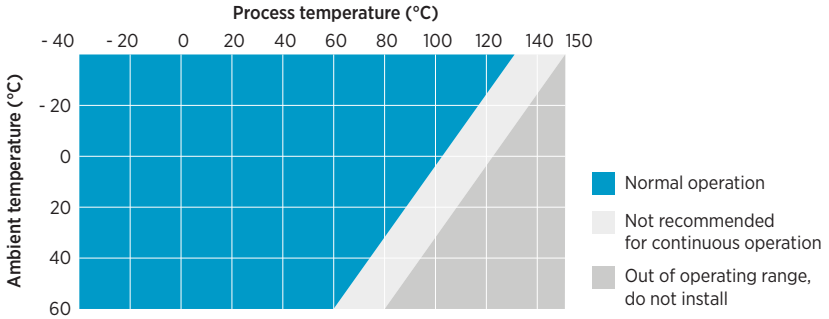

Figure 25 PR53GC process temperature (indicative)

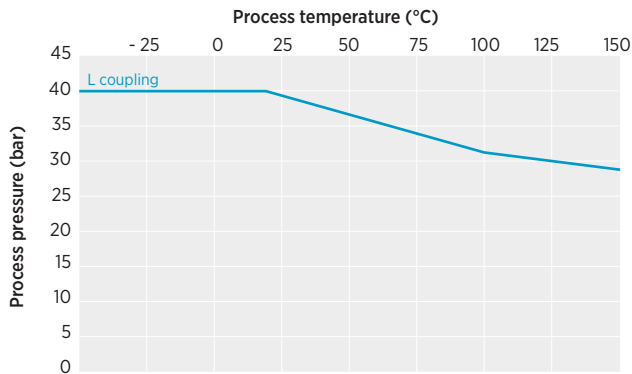

Figure 26 PR53GC process pressure

Table 22 Mechanical specifications

Property	Specification
Wetted parts	
Sensor head	EN 1.4404 (AISI 316L) EN 2.4660 (Alloy 20) EN 2.4819 (Alloy C276) 1)
Surface roughness	Ra 0.8 µm
Prism	Sapphire monocrystalline, 99.996 % Al ₂ O ₃ 2)
Prism gasket	Modified PTFE 2)

Property	Specification
L coupling gasket	PTFE ²⁾
Welding ferrule	EN 1.4404 (AISI 316L) EN 2.4660 (Alloy 20) EN 2.4819 (Alloy C276) ²⁾
Non-wetted parts	
Housing	EN 1.4404 (AISI 316L)
Screws, TX20, torque 2.0 Nm	EN 1.4404 (AISI 316L)
Cable gland	EN 1.4305 (AISI 303) HUMMEL 1.693.1600.50
Dummy plug	EN 1.4305 (AISI 303) AGRO 8717.96.08.70
Conduit hub	EN 1.4404 (AISI 316L) Vaisala, DRW257718, M16×1.5 / NPT ½ in
M12 connector	Gland, EN 1.4305 (AISI 303) Contacts, CuZn with Ni/Au plating Phoenix Contact, 1405233, M12/4(M), A, 4×0.34 mm ² , TPE, 0.5 m Carrier, PA 6.6
L coupling clamp (60.3 mm)	EN 1.4301 (AISI 304) ²⁾
Cable	4×22 AWG PUR, black 10 m multistrand, with ferrules Flame-retardant acc. to IEC 60332-1-2, FT1, VW1
Weight	2.7 kg (5.95 lb)

1) *Material certificate included.*

2) *Manufacturer's declaration included.*

10.6 PR53GP specifications

Table 23 Operating environment

Property	Specification
Process parameters	
Ambient temperature	-40 ... +60 °C (-40 ... +140 °F)

Property	Specification
Process temperature	-40 ... +150 °C (-40 ... +302 °F) ¹⁾
Design temperature	+180 °C (356 °F) ²⁾
Design pressure	40 bar ³⁾

- 1) -40 ... +130 °C EPDM gasket, -40... +150 °C EHEDG gasket.
- 2) Maximum momentary temperature peak.
- 3) Maximum at +20 °C, operating pressure to the clamp rating pressure.

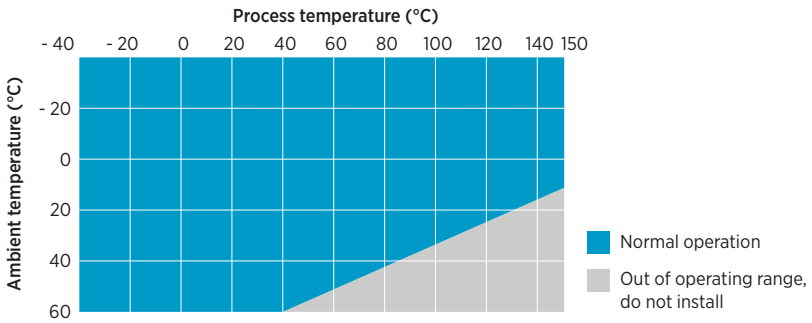

Figure 27 PR53GP process temperature (indicative)

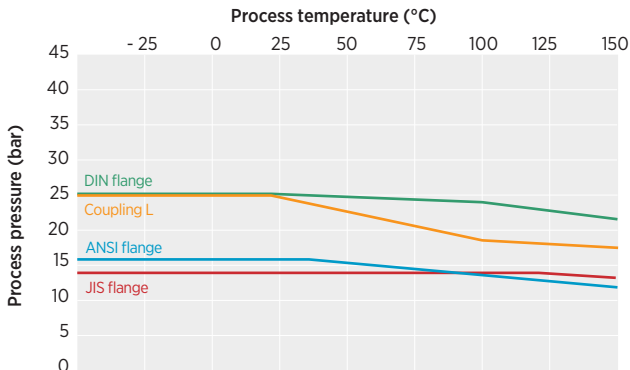

Figure 28 PR53GP process pressure

Table 24 Mechanical specifications

Property	Specification
Wetted parts	
Sensor head	EN 1.4404 (AISI 316L) ¹⁾
Surface roughness	Ra 0.8 µm
Prism	Sapphire monocrystalline, 99.996 % Al ₂ O ₃ ²⁾
Prism gasket	Modified PTFE ²⁾
L coupling gasket	PTFE ²⁾
L coupling welding ferrule	EN 1.4404 (AISI 316L) ¹⁾
Wash nozzle parts	EN 1.4404 (AISI 316L) ¹⁾
Non-wetted parts	
Housing	EN 1.4404 (AISI 316L)
Screws TX20, torque 2.0 Nm	EN 1.4404 (AISI 316L)
Cable gland	EN 1.4305 (AISI 303) HUMMEL 1.693.1600.50
Dummy plug	EN 1.4305 (AISI 303) AGRO 8717.96.08.70
Conduit hub	EN 1.4404 (AISI 316L) Vaisala, DRW257718, M16×1.5 / NPT ½ in
M12 connector	Gland, EN 1.4305 (AISI 303) Contacts, CuZn with Ni/Au plating Phoenix Contact, 1405233, M12/4(M), A, 4×0.34 mm ² , TPE, 0.5 m Carrier, PA 6.6
Flange	EN 1.4404 (AISI 316L) Dimensioning and tolerances as per ASME B16.5, DIN 2543, JIS B2220
L coupling clamp, 88.9 mm	EN 1.4301 (AISI 304)
Cable	4×22 AWG PUR, gray 10 m multistrand, with ferrules Flame-retardant acc. to IEC 60332-1-2, FT1, VW1

Property	Specification
Weight	PR53GP 2" flange 7.2 kg (15.87 lb) - 7.7 kg (16.98 lb) PR53GP 3" flange 10.5 kg (23.15 lb) - 11.7 kg (25.79 lb) PR53 L coupling 5.1 kg (11.24 lb)

- 1) *Material certificate included.*
- 2) *Manufacturer's declaration included.*

10.7 Spare parts and accessories

When in need of spare parts, contact your local distributor.

10.7.1 Interconnecting cable specifications

Table 25 Interconnecting cable specifications

Property	Specification
Maximum cable run	300 m (approx. 1000 ft)
Type	Shielded, multistrand
Dimensions	OD 5–10 mm (0.20–0.39 in), 0.2–2.5 mm ² (AWG 24–14), stripping length 10–12 mm (0.39–0.47 in)
Circuit breaker (between Indigo520 and power source)	1 A (slow)

10.8 Recycling instructions

These recycling instructions guide you on the end-of-life treatment of this Vaisala product. As waste regulations and infrastructure vary in each country, these instructions only indicate the different components to be separated and common ways to handle them. Always follow local requirements when disposing of the product. Vaisala encourages to use the best available recycling practices to minimize related environmental impacts.



Vaisala is committed to meeting the requirements of the EU Waste Electrical and Electronic Equipment (WEEE) Directive. This directive aims to minimize the impact of electrical and electronic goods on the environment, by increasing reuse and recycling, and reducing the amount of WEEE going to landfill. This symbol indicates that the product should be collected separately from other waste streams and treated appropriately.

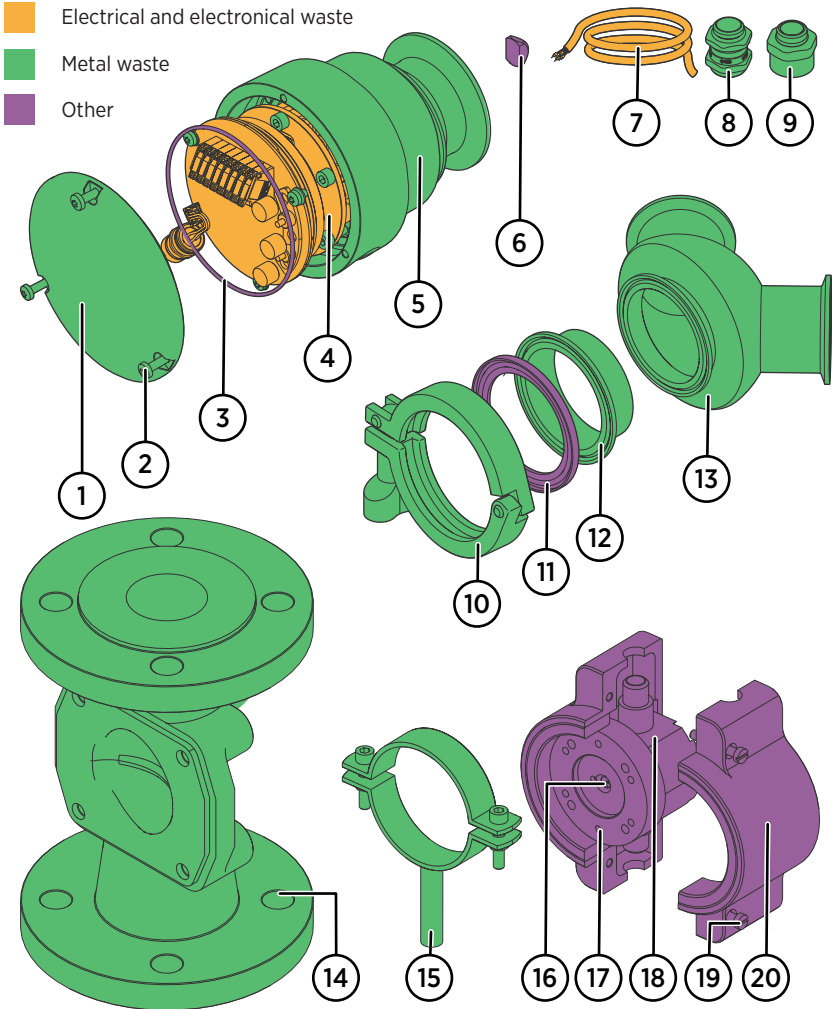

Figure 29 Materials for recycling

Table 26 Materials for recycling

Part	Material	Recycling
1	Cover	Stainless Steel Metal waste

	Part	Material	Recycling
2	Screws and washers	Stainless steel	Metal waste
3	O-rings	FPM	Other
4	Electronics	Various	Electrical and electronic waste
5	Enclosure	Stainless Steel	Metal waste
6	Prism	Sapphire	Other
7	cables	Various	Electrical and electronic waste
8	Cable gland	Various	Metal waste
9	Conduit hub	Various	Metal waste
10	Clamps	Stainless steel	Metal waste
11	Gaskets	Various	Other
12	Ferrule	Stainless steel	Metal waste
13	Flow cells	Stainless steel	Metal waste
14	Saunders body	SG iron	Metal waste
15	PR53M support	Stainless steel	Metal waste
16	PR53M sapphire plate	Sapphire	Other
17	PR53M head ring	PVDF	Other
18	PR53M flow cell	PTFE	Other
19	PR53M screws	PEEK	Other
20	PR53M light cover	PP-C	Other

11. Modbus registers

11.1 Modbus registers

Table 27 Measurement data registers (read-only)

Register number (decimal)	Address (hexadecimal)	Register description	Data format	Unit
3	0002 _{hex}	Concentration	32-bit float	*
	0003 _{hex}			
5	0004 _{hex}	Temperature	32-bit float	°C
	0005 _{hex}			
7	0006 _{hex}	Raw concentration	32-bit float	*
	0007 _{hex}			
9	0008 _{hex}	Refractive index	32-bit float	
	0009 _{hex}			
11	000A _{hex}	Quality factor	16-bit integer	

* Depends on the active concentration curve

Table 28 Measurement diagnostic registers (read-only)

Register number (decimal)	Address (hexadecimal)	Register description	Data format	Unit/ Valid range /Writable
529	0210 _{hex}	Light area	32-bit float	%
	0211 _{hex}			
531	0212 _{hex}	Ambient light	32-bit integer	
	0213 _{hex}			
533	0214 _{hex}	Internal temperature	32-bit float	°C
	0215 _{hex}			
535	0216 _{hex}	Internal relative humidity	32-bit float	%RH
	0217 _{hex}			

Register number (decimal)	Address (hexadecimal)	Register description	Data format	Unit/ Valid range /Writable
537	0218 _{hex}	Light exposure	32-bit float	%
	0219 _{hex}			
539	021A _{hex}	Analog output 1 output level	32-bit float	mA
	021B _{hex}			
541	021C _{hex}	Adjusted concentration	32-bit float	*
	021D _{hex}			
543	021E _{hex}	Adjusted temperature	32-bit float	°C
	021F _{hex}			
545	0220 _{hex}	Raw temperature	32-bit float	°C
	0221 _{hex}			
547	0222 _{hex}	Measurement number	32-bit integer	
	0223 _{hex}			
553	0228 _{hex}	Temperature stable	16-bit integer	0 = not stable 1 = stable

* Depends on the active concentration curve

Table 29 Status registers (read-only)

Register number (decimal)	Address (hexadecimal)	Register description	Data format
515	0202 _{hex}	Error code	32-bit integer
	0203 _{hex}		
517	0204 _{hex}	Error subcode	32-bit integer
	0205 _{hex}		

Error subcode is meant to be sent to Vaisala service along with error code.

Table 30 Error code encoding

M	3	2	2	2	2	2	2	...	17	16	15	14	13	12	11	10	...	6	5	4	3	2	1	L	S	B
S	0	9	8	7	6	5	4																			
B																										
System									Environment				Calculation				Temperature			Image						

Error code register value	Corresponding error
Image detection status	
1	Image quality low.
2	External light level high.
3	Prism coating detected.
4	No liquid detected.
5	No optical image.
6	External light level too high.
Temperature measurement status	
1	Temperature measurement error.

Measurement statuses are listed in priority order. Higher values are prioritized.

Error code register value	Corresponding error
Calculation errors	
01 _{hex}	Concentration out of concentration curve range.
02 _{hex}	Temperature out of concentration curve range.
04 _{hex}	Invalid calculation parameters.
08 _{hex}	Calibration mode active.
Environmental errors	
01 _{hex}	Internal temperature too high.
02 _{hex}	Internal humidity too high.
System errors	
01 _{hex}	Blank image corrupted.

If several errors are active at the same time, the Modbus error code register contains the sum of currently active error codes.

Table 31 Device information registers (read-only)

Register number (decimal)	Address (hexadecimal)	Register description	Data format	Example output
7425	1D00 _{hex} -1D07 _{hex}	VendorName	text	“Vaisala Oyj”

Register number (decimal)	Address (hexadecimal)	Register description	Data format	Example output
7433	1D08 _{hex} – 1D0F _{hex}	ProductCode	text	“PR53”
7441	1D10 _{hex} –1D17 _{hex}	SerialNumber	text	“J1140501”
7449	1D18 _{hex} – 1D1F _{hex}	FirmwareVersion	text	“1.0.0”

Table 32 Configuration registers

Register number (decimal)	Address (hexadecimal)	Register description	Data format	Unit / Valid range
Damping				
771	0302 _{hex}	Damping type	16-bit integer	0 = Exponential 1 = Linear 2 = Slew rate
772	0303 _{hex}	Damping time	16-bit integer	s
773	0304 _{hex}	Slew rate	32-bit float	*
	0305 _{hex}			
775	0306 _{hex}	Tolerance time	16-bit integer	s
Concentration curve management				
776	0307 _{hex}	Number of concentration curves	16-bit integer	Read-only
778	0309 _{hex}	Select curve	16-bit integer	0 = concentration curve 1 1 = concentration curve 2 2 = concentration curve 3 3 = concentration curve 4
Communication				
1537	0600 _{hex}	Address	16-bit integer	1–247

Register number (decimal)	Address (hexadecimal)	Register description	Data format	Unit / Valid range
1538	0601 _{hex}	Bit rate (b/s)	16-bit integer	0 = 300 1 = 600 2 = 1200 3 = 2400 4 = 4800 5 = 9600 6 = 19200 7 = 28800 8 = 38400 9 = 57600 10 = 76800 11 = 115200
1539	0602 _{hex}	Parity, data, stop bits	16-bit integer	0 = None, 8, 1 1 = None, 8, 2 2 = Even, 8, 1 3 = Even, 8, 2 4 = Odd, 8, 1 5 = Odd, 8, 2
1540	0603 _{hex}	Response delay	16-bit integer	0-1000 ms
1541	0604 _{hex}	Restart device	16-bit integer	When writing to register: 1 = Restart the device
Analog output 1				
1794	0701 _{hex}	Scale low end	32-bit float	*
	0702 _{hex}			
1796	0703 _{hex}	Scale high end	32-bit float	*
	0704 _{hex}			
1798	0705 _{hex}	Error output level	32-bit float	0.0-20.5 mA
	0706 _{hex}			
1800	0707 _{hex}	No sample error output	16-bit integer	0 = Disabled 1 = Enabled

Register number (decimal)	Address (hexadecimal)	Register description	Data format	Unit / Valid range
1801	0708 _{hex}	No sample error output level	32-bit float	0.0–20.5 mA
	0709 _{hex}			
Temperature offset				
8967	2306 _{hex}	T offset	32-bit float	°C

* Depends on the active concentration curve

Table 33 Concentration curve configuration registers

Register number (decimal)	Address (hexadecimal)	Register description	Data format	Unit	Writable
0 + base	0000 _{hex} – 0004 _{hex} + base	Identifier	text		No
5 + base	0005 _{hex} + base	Solvent type	16-bit integer	0 = Other 1 = Water-based	No
6 + base	0006 _{hex} + base	Concentration minimum	32-bit float	*	No
	0007 _{hex} + base				
8 + base	0008 _{hex} + base	Concentration maximum	32-bit float	*	No
	0009 _{hex} + base				
10 + base	000A _{hex} + base	Temperature minimum	32-bit float	°C	No
	000B _{hex} + base				
12 + base	000C _{hex} + base	Temperature maximum	32-bit float	°C	No
	000D _{hex} + base				

Register number (decimal)	Address (hexadecimal)	Register description	Data format	Unit	Writable
14 + base	000E _{hex} - 002D _{hex} + base	Description	text		No
95 + base	005F _{hex} + base	Chemical coefficients, C00	32-bit float		Yes
	0060 _{hex} + base				
97 + base	0061 _{hex} + base	Chemical coefficients, C01	32-bit float		Yes
	0062 _{hex} + base				
99 + base	0063 _{hex} + base	Chemical coefficients, C02	32-bit float		Yes
	0064 _{hex} + base				
101 + base	0065 _{hex} + base	Chemical coefficients, C03	32-bit float		Yes
	0066 _{hex} + base				
103 + base	0067 _{hex} + base	Chemical coefficients, C10	32-bit float		Yes
	0068 _{hex} + base				
105 + base	0069 _{hex} + base	Chemical coefficients, C11	32-bit float		Yes
	006A _{hex} + base				
107 + base	006B _{hex} + base	Chemical coefficients, C12	32-bit float		Yes
	006C _{hex} + base				
109 + base	006D _{hex} + base	Chemical coefficients, C13	32-bit float		Yes
	006E _{hex} + base				

Register number (decimal)	Address (hexadecimal)	Register description	Data format	Unit	Writable
111 + base	006F _{hex} + base	Chemical coefficients, C20	32-bit float		Yes
	0070 _{hex} + base				
113 + base	0071 _{hex} + base	Chemical coefficients, C21	32-bit float		Yes
	0072 _{hex} + base				
115 + base	0073 _{hex} + base	Chemical coefficients, C22	32-bit float		Yes
	0074 _{hex} + base				
117 + base	0075 _{hex} + base	Chemical coefficients, C23	32-bit float		Yes
	0076 _{hex} + base				
119 + base	0077 _{hex} + base	Chemical coefficients, C30	32-bit float		Yes
	0078 _{hex} + base				
121 + base	0079 _{hex} + base	Chemical coefficients, C31	32-bit float		Yes
	007A _{hex} + base				
123 + base	007B _{hex} + base	Chemical coefficients, C32	32-bit float		Yes
	007C _{hex} + base				
125 + base	007D _{hex} + base	Chemical coefficients, C33	32-bit float		Yes
	007E _{hex} + base				
127 + base	007F _{hex} ... 009E _{hex} + base	Name	text		Yes
159 + base	009F _{hex} + base	Field offset	32-bit float	*	Yes
	00A0 _{hex} + base				

Register number (decimal)	Address (hexadecimal)	Register description	Data format	Unit	Writable
131 + base	00A1 _{hex} + base	Field gain	32-bit float		Yes
	00A2 _{hex} + base				
Concentration curve bases					
3073	0C00 _{hex}	Concentration curve 1			
3329	0D00 _{hex}	Concentration curve 2			
3585	0E00 _{hex}	Concentration curve 3			
3841	0F00 _{hex}	Concentration curve 4			

* Depends on the active concentration curve

Table 34 Test value registers

Register number (decimal)	Address (hexadecimal)	Register description	Data format	Test value
7937	1F00 _{hex}	Signed integer test	16-bit integer	-12345
7938	1F01 _{hex}	Floating point test	32-bit float	-123.45
	1F02 _{hex}			
7940	1F03 _{hex}	Text string test	text	Text string "-123.45"
	1F04 _{hex}			
	1F05 _{hex}			
	1F06 _{hex}			

Table 35 Device identification objects

Object ID	Object ID (hexadecimal)	Object name	Example contents
0	00 _{hex}	VendorName	"Vaisala"
1	01 _{hex}	ProductCode	"PR53"
2	02 _{hex}	MajorMinorVersion	"1.0.0"
3	03 _{hex}	VendorUrl	"https://www.vaisala.com"

Object ID	Object ID (hexadecimal)	Object name	Example contents
4	04 _{hex}	ProductName	“Polaris™ process refractometer”
5	05 _{hex}	ModelName	“PR53AC”
128	80 _{hex}	SerialNumber ¹⁾	“J1140501”
129	81 _{hex}	CalibrationDate ¹⁾	“2023-04-21” Calibration date in YYYY-MM-DD format. Empty string if not set/valid.
130	82 _{hex}	CalibrationText ¹⁾	“Vaisala/HEL” Calibration information text. Empty string if not set/valid.

1) *Vaisala-specific device information object*

More information

- [Modbus RTU \(page 24\)](#)
- [Configuring Modbus communication settings with Insight \(page 60\)](#)

Appendix A. Principle of measurement

The Vaisala K-PATENTS® inline process refractometer determines the refractive index (RI) of the process solution. It measures the critical angle of refraction using a yellow LED light source with the same wavelength (589 nm) as the sodium D line. Light from the light source (L) in the following figure is directed to the interface between the prism (P) and the process medium (S). Two of the prism surfaces (M) act as mirrors bending the light rays so that they meet the interface at different angles.

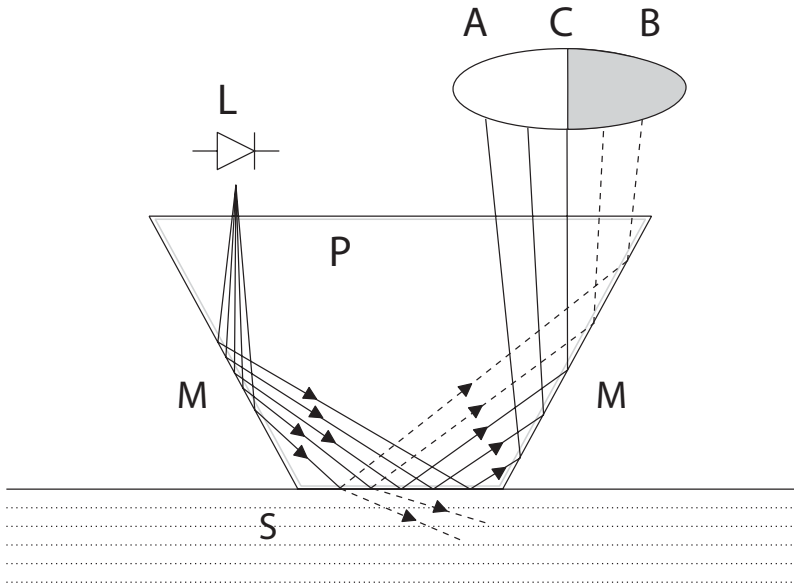

Figure 30 Refractometer principle

The reflected rays of light form an image (ACB), where (C) is the position of the critical angle ray. The rays at (A) are totally internally reflected at the process interface, the rays at (B) are partially reflected and partially refracted into the process solution. In this way the optical image is divided into a light area (A) and a dark area (B). The position of the shadow edge (C) indicates the value of the critical angle. The refractive index can then be determined from this position.

The refractive index changes with the process solution concentration and temperature. For most solutions the refractive index increases when the concentration increases. At higher temperatures the refractive index is smaller than at lower temperatures. From this follows that the optical image changes with the process solution concentration as shown in the following figure. The color of the solution, gas bubbles or undissolved particles do not affect the position of the shadow edge (C).

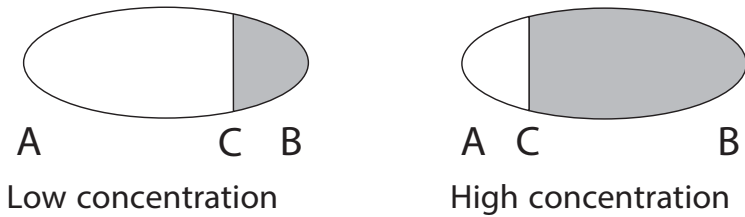

Figure 31 Optical images

The position of the shadow edge is measured digitally using a CCD element and is converted to a refractive index value by a processor inside the instrument. This value is used together with the measured process temperature to calculate the concentration.

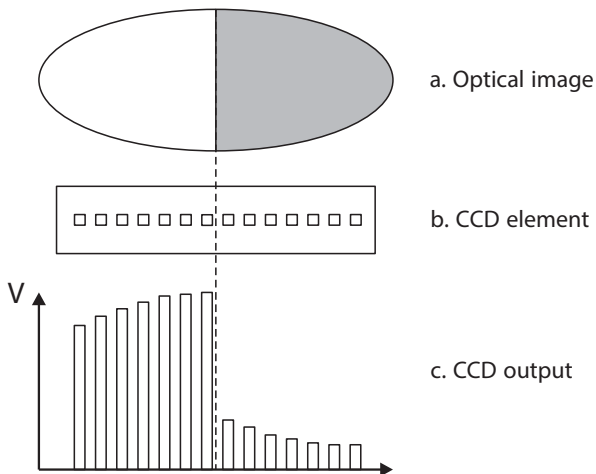

Figure 32 Optical image detection

Appendix B. Analyzing optical image

The optical image can tell you about problems, for example, with the condition of the prism.

Y-axis is light intensity and X-axis the position of the shadow edge. RI calibration follows the X-axis. The position of RI measurement on X-axis is at the steepest curve drop, being the highest angle at the corner.

Table 36 Analyzing the optical image

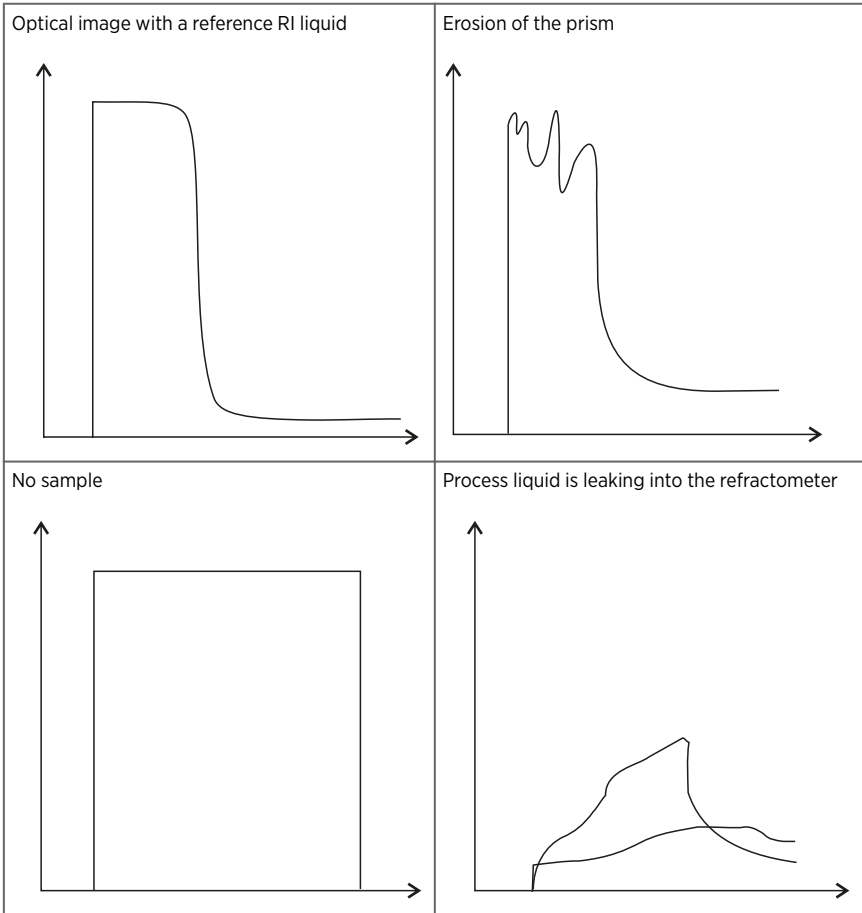

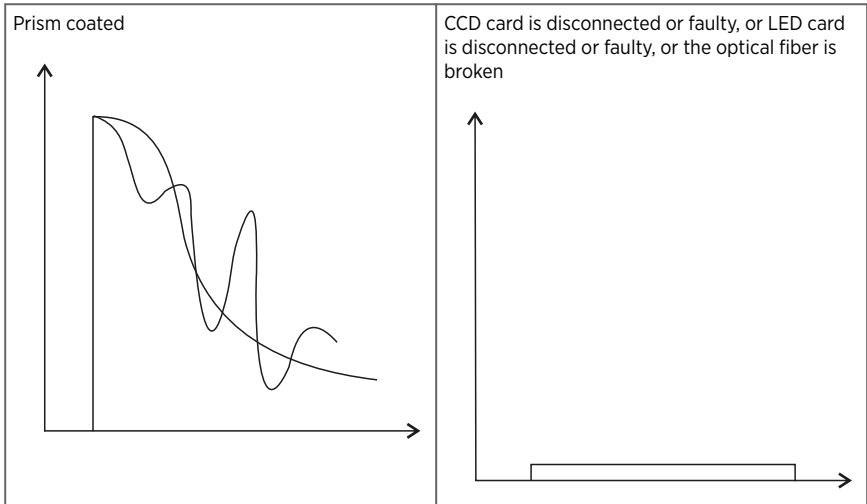
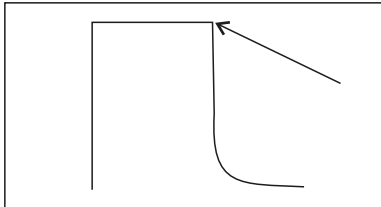
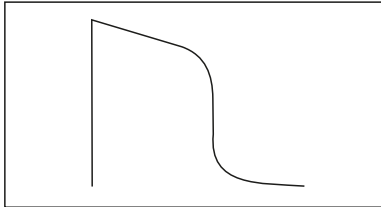
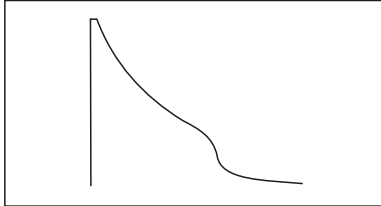

Table 37 Prism scaling

	<p>Good</p> <ul style="list-style-type: none"> • Measurement status Normal operation. • Observe the angle, drop from high intensity light to low light intensity should be as steep as possible.
	<p>Compromised</p> <ul style="list-style-type: none"> • Measurement status Normal operation. • Scaling has started • Measurement starts to drift up • Perform manual cleaning
	<p>Heavy scaling</p> <ul style="list-style-type: none"> • Measurement status No liquid detected or Prism coating detected. • Measurement 0% • Immediate manual wash needed. See PR53 Prism Wash System User Guide (M212808EN).

Maintenance and calibration services



Vaisala offers comprehensive customer care throughout the life cycle of our measurement instruments and systems. Our factory services are provided worldwide with fast deliveries. For more information, see www.vaisala.com/calibration.

- Vaisala Online Store at store.vaisala.com is available for most countries. You can browse the offering by product model and order the right accessories, spare parts, or maintenance and calibration services.
- To contact your local maintenance and calibration expert, see www.vaisala.com/contactus.

Warranty

For standard warranty terms and conditions, see www.vaisala.com/warranty.

Please observe that any such warranty may not be valid in case of damage due to normal wear and tear, exceptional operating conditions, negligent handling or installation, or unauthorized modifications. Please see the applicable supply contract or Conditions of Sale for details of the warranty for each product.

Technical support



Contact Vaisala technical support at helpdesk@vaisala.com. Provide at least the following supporting information as applicable:

- Product name, model, and serial number
- Software/Firmware version
- Name and location of the installation site
- Name and contact information of a technical person who can provide further information on the problem

For more information, see www.vaisala.com/support.

VAISALA

www.vaisala.com

