

VALVOLA DI SFIORO TIPO MVS/1 - MVSP/1  
RELIEF VALVE TYPE MVS/1 - MVSP/1  
SOUPAPE D'EFFLEUREMENT TYPE MVS/1 - MVSP/1  
VÁLVULA DE ALIVIO TIPO MVS/1 - MVSP/1



**DESCRIZIONE**

Le valvole di sfioro, con comando a molla e a scarico automatico, hanno il compito di assorbire e scaricare all'esterno i picchi di pressione (colpi d'ariete).

Per la loro capacità di scarico le valvole di sfioro trovano ideale collocazione in tutte le utenze, civili ed industriali, di gas metano, butano, propano, ed altri gas non corrosivi.

**In conformità a:**

**Direttiva PED 2014/68/UE**  
(ex 97/23/CE)

**Direttiva ATEX 2014/34/UE**  
(ex 94/9/CE)

**CARATTERISTICHE TECNICHE**

- Impiego:  
gas non aggressivi delle 3 famiglie (gas secchi)
- Attacchi filettati Rp:  
(DN 8) secondo EN 10226
- Attacchi filettati Rp:  
(DN 15 ÷ DN 50) secondo EN 10226
- Attacchi flangiati PN 16:  
(DN 25 - DN 32 - DN 40 - DN 50)  
secondo ISO 7005
- Su richiesta attacchi flangiati ANSI 150
- Pressione max esercizio:  
1 bar, 1,5 bar, 2,5 bar o 6 bar  
(vedere etichetta prodotto)
- Temperatura ambiente:  
-15 ÷ +60 °C
- Temperatura superficiale max:  
60 °C

**MATERIALI**

- Alluminio pressofuso (UNI EN 1706)
- ottone OT-58 (UNI EN 12164)
- alluminio 11S (UNI 9002-5)
- acciaio zincato e acciaio INOX 430 F (UNI EN 10088)
- gomma antiolio NBR (UNI 7702)

**DESCRIPTION**

The relief valves with automatic exhaust spring control, absorb and release outside pressure peaks in the flow.

Thanks to their discharge capacity, these overflow valves find ideal application in all civil and industrial methane, butane, propane and other not corrosive gas users.

**In conformity with:**

**2014/68/EU PED Directive**  
(ex 97/23/EC)

**2014/34/EU ATEX Directive**  
(ex 94/9/EC)

**TECHNICAL DATA**

- Use:  
not aggressive gases of the 3 families (dry gases)
- Threaded connections Rp:  
(DN 8) according to EN 10226
- Threaded connections Rp:  
(DN 15 ÷ DN 50) according to EN 10226
- Flanged connections PN 16:  
(DN 25 - DN 32 - DN 40 - DN 50)  
according to ISO 7005
- On request ANSI 150 flanged connections
- Max. working pressure:  
1 bar, 1,5 bar, 2,5 bar or 6 bar  
(see product label)
- Environment temperature:  
-15 ÷ +60 °C
- Max superficial temperature:  
60 °C

**MATERIALS**

- Die-cast aluminium (UNI EN 1706)
- OT-58 brass (UNI EN 12164)
- 11S aluminium (UNI 9002-5)
- galvanized and 430 F stainless steel (UNI EN 10088)
- NBR rubber (UNI 7702)

**DESCRIPTION**

Les soupapes d'effleurement, avec commande à ressort et à rejet automatique, ont le rôle d'absorber et rejeter à l'extérieur les pics de pression (coups de bélier).

Pour leur capacité de rejet les soupapes d'effleurement trouvent des applications idéales dans toutes les utilisations, civiles et industrielles, de gaz méthane, butane, propane, et autres gaz non corrosifs.

**Conforme à:**

**Directive PED 2014/68/UE**  
(ex 97/23/CE)

**Directive ATEX 2014/34/UE**  
(ex 94/9/CE)

**CARACTERISTIQUES TECHNIQUES**

- Emploi:  
gaz non agressifs des 3 familles (gaz secs)
- Fixations filetees Rp:  
(DN 8) selon EN 10226
- Fixations filetees Rp:  
(DN 15 ÷ DN 50) selon EN 10226
- Connecteurs flangés PN 16:  
(DN 25 - DN 32 - DN 40 - DN 50)  
selon ISO 7005
- Sur demande fixations bridees ANSI 150
- Pression maximale en exercice:  
1 bar, 1,5 bar, 2,5 bar ou 6 bar  
(voir étiquette du produit)
- Température ambiante:  
-15 ÷ +60 °C
- Température superficielle max:  
60 °C

**MATÉRIELS**

- Aluminium fondé dans la masse (UNI EN 1706)
- laiton OT-58 (UNI EN 12164)
- aluminium 11S (UNI 9002-5)
- acier zingué et acier INOX 430 F (UNI EN 10088)
- caoutchou anti-huile NBR (UNI 7702)

**DESCRIPCIÓN**

Las válvulas de alivio, con control de muelle y con escape automático, tienen que absorber y descargar al exterior la corriente de carga máxima.

Para sus capacidades de escape, las válvulas de alivio encuentran ideal colocación en todos los puntos de consumo, civiles y industriales, de gas metano, butano, propano y otros gases no corrosivos.

**Conforme:**

**Diretiva PED 2014/68/UE**  
(ex 97/23/CE)

**Diretiva ATEX 2014/34/UE**  
(ex 94/9/CE)

**CARACTERÍSTICAS TÉCNICAS**

- Utilización:  
gases de las 3 familias (secos y no agresivos)
- Conexiones roscadas Rp:  
(DN 8) según EN 10226
- Conexiones roscadas Rp:  
(DN 15 ÷ DN 50) según EN 10226
- Enganches con bridas PN 16:  
(DN 25 - DN 32 - DN 40 - DN 50)  
en conformidad con ISO 7005
- A petición conexiones de brida ANSI 150
- Max. presión ejercicio:  
1 bar, 1,5 bar, 2,5 bar o 6 bar  
(ver etiqueta producto)
- Temperatura ambiente:  
-15 ÷ +60 °C
- Temperatura superficial máxima:  
60 °C

**MATERIALES**

- Aluminio inyectado a presión (UNI EN 1706)
- latón OT-58 (UNI EN 12164)
- aluminio 11S (UNI 9002-5)
- acero inox 430 F y acero galvanizado (UNI EN 10088)
- goma antiaceite NBR (UNI 7702)

## G 1/4" CONNECTIONS VERSION





FOTO PHOTO PHOTO FOTO	Ø	P.MAX (bar)	TARATURA (mbar) SETTING (mbar) TARAGE (mbar) TARADO (mbar)	ATTACCHI FILETTATI - THREADED CONNECTIONS FIXATIONS FILETEES - CONEXIONES ROSCADAS	
				CODICE - CODE CODE - CÓDIGO	
	DN 8	1	40 ÷ 90	VS01	005
		1	80 ÷ 180	VS01	010
		1	100 ÷ 360	VS01	020
		1	280 ÷ 500	VS01	030

FIG N° 1				
	<p>1 - Tappo di chiusura 2 - Vite di regolazione 3 - Molla di taratura 4 - Otturatore 5 - Tappo antipolvere 6 - Corpo 7 - Membrana 8 - Imbuto</p>	<p>1 - Closing cap 2 - Regulation screw 3 - Setting spring 4 - Obturator 5 - Antidust cap 6 - Body 7 - Diaphragm 8 - Funnel</p>	<p>1 - Bouchon 2 - Vis de réglage 3 - Ressort de tarage 4 - Obturateur 5 - Bouchon anti-poussière 6 - Corps 7 - Membrane 8 - Entonnoir</p>	<p>1 - Tapón de cierre 2 - Tornillo de regulación 3 - Muelle de tarado 4 - Obturador 5 - Tapón antipolvo 6 - Cuerpo 7 - Membrana 8 - Embudo</p>

## COMPACT VERSION MVSP/1

FOTO PHOTO PHOTO FOTO	Ø	P.MAX (bar)	TARATURA (mbar) SETTING (mbar) TARAGE (mbar) TARADO (mbar)	ATTACCHI FILETTATI - THREADED CONNECTIONS FIXATIONS FILETEES - CONEXIONES ROSCADAS	
				CODICE - CODE CODE - CÓDIGO	
	DN 15 compact	1	18 ÷ 70	VSP02	010
		1	30 ÷ 120	VSP02	020
		1	70 ÷ 260	VSP02	030
	DN 20 compact	1	18 ÷ 80	VSP03	010
		1	40 ÷ 160	VSP03	020
		1	100 ÷ 300	VSP03	030
		1	50 ÷ 450	VSP030022	
	DN 25 compact	1	18 ÷ 80	VSP04	010
		1	40 ÷ 160	VSP04	020
		1	100 ÷ 300	VSP04	030
		1	50 ÷ 450	VSP040022	

FIG N°  
2

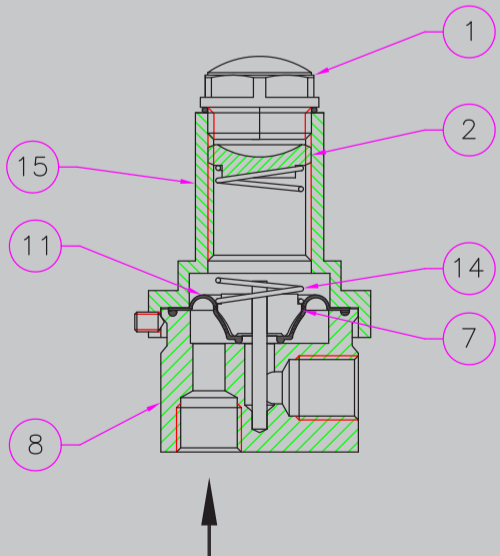

- 1 - Tappo di chiusura
- 2 - Molla di taratura
- 3 - Imbuto
- 4 - Viti di fissaggio
- 5 - Otturatore
- 6 - Rondella di tenuta
- 7 - Corpo
- 8 - Perno centrale
- 9 - Disco inferiore per membrana
- 10 - Membrana di funzionamento
- 11 - Disco superiore per membrana
- 12 - Membrana di sicurezza
- 13 - Tappo antipolvere
- 14 - Dado blocca membrana
- 15 - Vite di regolazione

- 1 - Closing cup
- 2 - Setting spring
- 3 - Funnel
- 4 - Fixing screws
- 5 - Obturator
- 6 - Washer seal
- 7 - Body
- 8 - Central pin
- 9 - Lower disc for membrane
- 10 - Working membrane
- 11 - Upper disc for membrane
- 12 - Safety membrane
- 13 - Antidust cap
- 14 - Membrane blocking nut
- 15 - Regulation screw

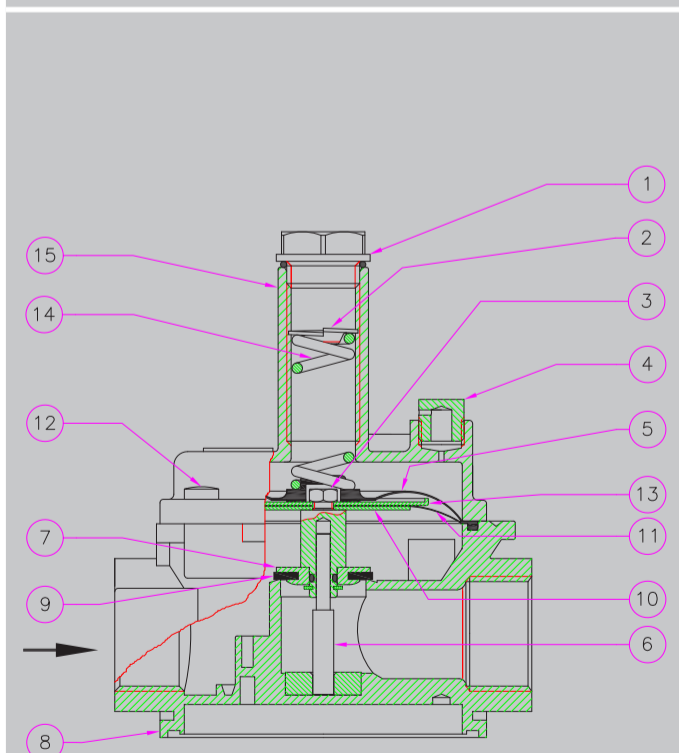
- 1 - Bouchon de fermeture
- 2 - Ressort de tarage
- 3 - Entonnoir
- 4 - Vis de fixation
- 5 - Obturateur
- 6 - Rondelle de tenue
- 7 - Corps
- 8 - Pivot central
- 9 - Disque inférieur pour membrane
- 10 - Membrane de fonctionnement
- 11 - Disque supérieur pour membrane
- 12 - Membrane de sécurité
- 13 - Bouchon anti-poussière
- 14 - Boulon bloque membrane
- 15 - Vis de réglage

- 1 - Tapón de cierre
- 2 - Muelle de tarado
- 3 - Embudo
- 4 - Tornillos de fijación
- 5 - Obturador
- 6 - Arandela de estanquidad
- 7 - Cuerpo
- 8 - Eje central
- 9 - Disco inferior membrana
- 10 - Membrana de trabajo
- 11 - Disco superior membrana
- 12 - Membrana de seguridad
- 13 - Tapón antipolvo
- 14 - Tuerca fijación membrana
- 15 - Tornillo de regulación

## MVS/1 STANDARD VERSION

FOTO PHOTO PHOTO FOTO	Ø	P.MAX (bar)	TARATURA (mbar) SETTING (mbar) TARAGE (mbar) TARADO (mbar)	ATTACCHI FILETTATI THREADED CONNECTIONS FIXATIONS FILETEES CONEXIONES ROSCADAS		ATTACCHI FILETTATI THREADED CONNECTIONS FIXATIONS FILETEES CONEXIONES ROSCADAS	
				CODICE - CODE CODE - CÓDIGO		CODICE - CODE CODE - CÓDIGO	
	DN 20	1	16 ÷ 37	VS03	005		
		1	30 ÷ 110	VS03	010		
		1	100 ÷ 160	VS03	020		
		1	140 ÷ 215	VS03	030		
		1	215 ÷ 500	VS03	040		
		1,5	200 ÷ 1000*	VS030022	010		
		2,5	700 ÷ 2100*	VS030022	020		
	DN 25	1	16 ÷ 37	VS04	005	VS25	005
		1	30 ÷ 110	VS04	010	VS25	010
		1	100 ÷ 160	VS04	020	VS25	020
		1	140 ÷ 215	VS04	030	VS25	030
		1	215 ÷ 500	VS04	040	VS25	040
		1,5	200 ÷ 1000*	VS040022	010	VS250022	010
		2,5	700 ÷ 2100*	VS040022	020	VS250022	020
DN 32	1	30 ÷ 110	VS05	010			
	1	110 ÷ 170	VS05	020			
	1	160 ÷ 300*	VS050022	010			
	1	260 ÷ 500*	VS050022	020			
	DN 40	1	30 ÷ 110	VS06	010		
		1	110 ÷ 170	VS06	020		
		1	160 ÷ 300*	VS060022	010		
		1	260 ÷ 500*	VS060022	020		

\* = Versione con membrana rinforzata \* = Version with reinforced diaphragm  
 \* = Version avec membrane renforcée \* = Versión con membrana reforzada

FIG N° 3				
	<ul style="list-style-type: none"> <li>1 - Tappo alluminio</li> <li>2 - Vite di regolazione</li> <li>3 - Dado blocca membrana</li> <li>4 - Tappo antipolvere</li> <li>5 - Membrana di sicurezza</li> <li>6 - Perno centrale</li> <li>7 - Otturatore</li> <li>8 - Corpo</li> <li>9 - Rondella di tenuta</li> <li>10 - Dischi per membrana</li> <li>11 - Membrana di funzionamento</li> <li>12 - Viti di fissaggio</li> <li>13 - Disco superiore per membrana</li> <li>14 - Molla di taratura</li> <li>15 - Imbuto</li> </ul>	<ul style="list-style-type: none"> <li>1 - Aluminium cap</li> <li>2 - Regulation screw</li> <li>3 - Nut for blocking diaphragm</li> <li>4 - Antidust cap</li> <li>5 - Safety diaphragm</li> <li>6 - Central pin</li> <li>7 - Obturator</li> <li>8 - Body</li> <li>9 - Seal washer</li> <li>10 - Diaphragm discs</li> <li>11 - Working diaphragm</li> <li>12 - Fixing screws</li> <li>13 - Diaphragm upper disc</li> <li>14 - Setting spring</li> <li>15 - Funnel</li> </ul>	<ul style="list-style-type: none"> <li>1 - Bouchon en aluminium</li> <li>2 - Vis de réglage</li> <li>3 - Boulon auto-bloquant</li> <li>4 - Bouchon anti-poussière</li> <li>5 - Membrane de sécurité</li> <li>6 - Pivot central</li> <li>7 - Obturateur</li> <li>8 - Corps</li> <li>9 - Rondelle de tenue</li> <li>10 - Disque inférieur pour membrane</li> <li>11 - Membrane de fonctionnement</li> <li>12 - Vis de fixation</li> <li>13 - Disque supérieur pour membrane</li> <li>14 - Ressort de tarage</li> <li>15 - Entonnoir</li> </ul>	<ul style="list-style-type: none"> <li>1 - Tapón de aluminio</li> <li>2 - Tornillo de regulación</li> <li>3 - Tuerca fijación membrana</li> <li>4 - Tapón antipolvo</li> <li>5 - Membrana de seguridad</li> <li>6 - Eje central</li> <li>7 - Obturador</li> <li>8 - Cuerpo</li> <li>9 - Arandela de estanquidad</li> <li>10 - Discos membrana</li> <li>11 - Membrana de funcionamiento</li> <li>12 - Tornillos de fijación</li> <li>13 - Disco superior membrana</li> <li>14 - Muelle de tarado</li> <li>15 - Embudo</li> </ul>

## MVS/1 STANDARD VERSION

FOTO PHOTO PHOTO	Ø	P.MAX (bar)	TARATURA (mbar) SETTING (mbar) TARAGE (mbar) TARADO (mbar)	ATTACCHI FILETTATI THREADED CONNECTIONS FIXATIONS FILETEES CONEXIONES ROSCADAS	
				CODICE - CODE CODE - CÓDIGO	CODICE - CODE CODE - CÓDIGO
	DN 32	1	20 ÷ 50		VS32 005
		1	35 ÷ 135		VS32 010
		1	110 ÷ 200		VS32 020
		1	200 ÷ 400*		VS320022 010
		1	320 ÷ 500*		VS320022 020
	DN 40	1	20 ÷ 50		VS40 005
		1	35 ÷ 135		VS40 010
		1	110 ÷ 200		VS40 020
		1	200 ÷ 400*		VS400022 010
		1	320 ÷ 500*		VS400022 020
	DN 50	1	20 ÷ 50	VS07 005	VS50 005
		1	35 ÷ 135	VS07 010	VS50 010
		1	110 ÷ 200	VS07 020	VS50 020
		1	200 ÷ 400*	VS070022 010	VS500022 010
		1	320 ÷ 500*	VS070022 020	VS500022 020

\* = Versione con membrana rinforzata \* = Version with reinforced diaphragm  
 \* = Version avec membrane renforcée \* = Versión con membrana reforzada

FIG N°  
4

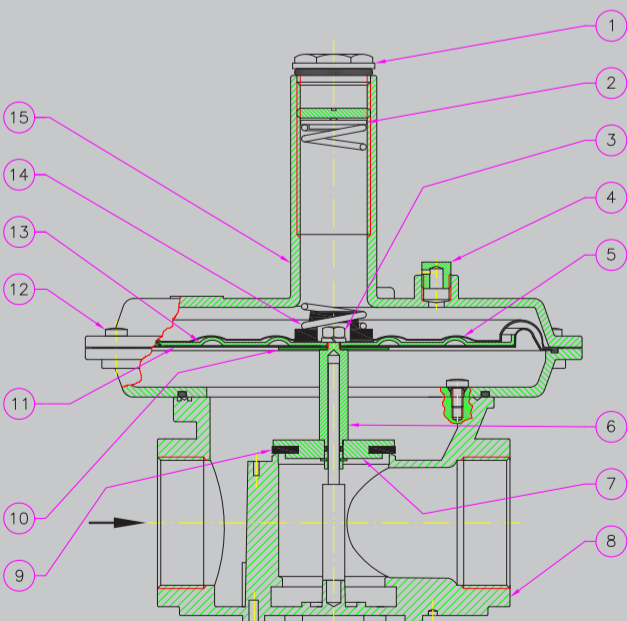

- 1 - Tappo alluminio
- 2 - Vite di regolazione
- 3 - Dado blocca membrana
- 4 - Tappo antipolvere
- 5 - Membrana di sicurezza
- 6 - Perno centrale
- 7 - Otturatore
- 8 - Corpo
- 9 - Rondella di tenuta
- 10 - Dischi per membrana
- 11 - Membrana di funzionamento
- 12 - Viti di fissaggio
- 13 - Disco superiore per membrana
- 14 - Molla di taratura
- 15 - Imbuto

- 1 - Aluminium cap
- 2 - Regulation screw
- 3 - Nut for blocking diaphragm
- 4 - Antidust cap
- 5 - Safety diaphragm
- 6 - Central pin
- 7 - Obturator
- 8 - Body
- 9 - Seal washer
- 10 - Diaphragm discs
- 11 - Working diaphragm
- 12 - Fixing screws
- 13 - Diaphragm upper disc
- 14 - Setting spring
- 15 - Funnel





- 1 - Bouchon en aluminium
- 2 - Vis de réglage
- 3 - Boulon auto-bloquant
- 4 - Bouchon anti-poussière
- 5 - Membrane de sécurité
- 6 - Pivot central
- 7 - Obturateur
- 8 - Corps
- 9 - Rondelle de tenue
- 10 - Disque inférieur pour membrane
- 11 - Membrane de fonctionnement
- 12 - Vis de fixation
- 13 - Disque supérieur pour membrane
- 14 - Ressort de tarage
- 15 - Entonnoir

- 1 - Tapón de aluminio
- 2 - Tornillo de regulación
- 3 - Tuerca fijación membrana
- 4 - Tapón antipolvo
- 5 - Membrana de seguridad
- 6 - Eje central
- 7 - Obturador
- 8 - Cuerpo
- 9 - Arandela de estanquidad
- 10 - Discos membrana
- 11 - Membrana de funcionamiento
- 12 - Tornillos de fijación
- 13 - Disco superior membrana
- 14 - Muelle de tarado
- 15 - Embudo



**VERSIONE PRESSIONE DI TARATURA 0,3 ÷ 6 BAR - SETTING PRESSURE 0,3 ÷ 6 BAR VERSION**  
**VERSION PRESSION DE TARAGE 0,3 ÷ 6 BAR - VERSIÓN PRESIÓN DE TARADO 0,3 ÷ 6 BAR**

FOTO PHOTO FOTO	Ø	P.MAX (bar)	TARATURA (mbar) SETTING (mbar) TARAGE (mbar) TARADO (mbar)	ATTACCHI FILETTATI THREADED CONNECTIONS FIXATIONS FILETEES CONEXIONES ROSCADAS	ATTACCHI FILETTATI THREADED CONNECTIONS FIXATIONS FILETEES CONEXIONES ROSCADAS
				CODICE - CODE CODE - CÓDIGO	CODICE - CODE CODE - CÓDIGO
	DN 20	6	0,3 ÷ 6	VS030000	-
	DN 25	6	0,3 ÷ 6	VS040000	VS250000

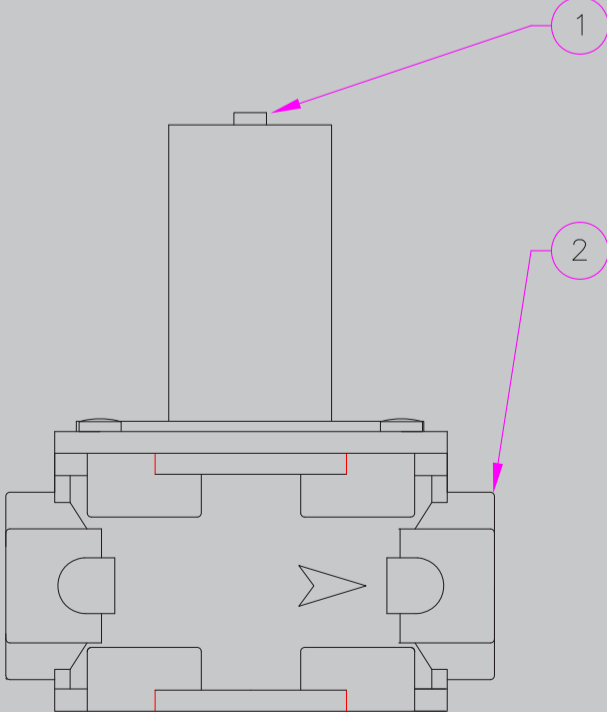
FIG N° 5				
	1 - Vite di regolazione 2 - Corpo	1 - Regulation screw 2 - Body	1 - Vis de réglage 2 - Corps	1 - Tornillo de regulación 2 - Cuerpo

MOLLE DI TARATURA - SETTING SPRINGS RESSORTS DE TARAGE - MUELLE DE TARADO				KIT MEMBRANE DIAPHRAGMS KIT MEMBRANE KIT KIT DE MEMBRANA
Ø	TARATURA (mbar) SETTING (mbar) TARAGE (mbar) TARADO (mbar)	CODICE CODE CODE CÓDIGO	DIMENSIONI IN MM (D X DE X LO X IT) DIMENSIONS IN MM (D X DE X LO X IT) MESURES EN MM (D X DE X LO X IT) DIMENSIONES EN MM (D X DE X LO X IT)	CODICE CODE CODE CÓDIGO
DN 8	40 ÷ 90	MO-0104	0,8x17x40x6	KIT-MEVS 8
	80 ÷ 180	MO-0153	0,9x17x45x7	
	100 ÷ 360	MO-0204	1x17x22x4	
	280 ÷ 500	MO-0223	1x17x70x10	
DN 15 compact	18 ÷ 70	MO-0213	1,3x17x55x8	KIT-MEVB
	30 ÷ 120	MO-0215	1,8x18,4x45x8,5	
	70 ÷ 260	MO-2150	2x17x54x9	
DN 20 - DN 25 compact	18 ÷ 80	MO-0213	1,3x17x55x8	KIT-MEVB
	40 ÷ 160	MO-0215	1,8x18,4x45x8,5	
	100 ÷ 300	MO-2150	2x17x54x9	
	50 ÷ 450	MO-2160	2,2x17,5x66x11	
DN 20 - DN 25	16 ÷ 37	MO-0500	1,6x29x115x12	KIT-MEVS 25
	30 ÷ 110	MO-0825	2,2x29x100x12	
	100 ÷ 160	MO-0900	2,5x29x140x18,5	
	140 ÷ 215	MO-0970	2,5x29x155x16	
	215 ÷ 500	MO-1305	3,5x29,8x98x11,5	
	200 ÷ 1000	MO-2550*	4x29x98x8	
attacchi filettati threaded connections DN 32 - DN 40	30 ÷ 110	MO-0825	2,2x29x100x12	KIT-MEVS 25
	110 ÷ 170	MO-0900	2,5x29x140x18,5	
	160 ÷ 300	MO-0970*	2,5x29x155x16	
	260 ÷ 500	MO-1305*	3,5x29,8x98x11,5	
attacchi filettati threaded connections DN 50	20 ÷ 50	MO-0900	2,5x29x140x18,5	KIT-MEVS 50
	35 ÷ 135	MO-1305	3,5x29,8x98x11,5	
	130 ÷ 200	MO-1300	3,5x29,8x150x16	
	200 ÷ 400	MO-2550*	4x29x98x8	
	320 ÷ 500	MO-2580*	4,6x29,4x95x9	
attacchi flangiati flanged connections DN 32 - DN 40 - DN 50	20 ÷ 50	MO-0900	2,5x29x140x18,5	KIT-MEVS 50
	35 ÷ 135	MO-1305	3,5x29,8x98x11,5	
	130 ÷ 200	MO-1300	3,5x29,8x150x16	
	200 ÷ 400	MO-2550*	4x29x98x8	
	320 ÷ 500	MO-2580*	4,6x29,4x95x9	

\* = Versione con membrana rinforzata \* = Version with reinforced diaphragm  
\* = Version avec membrane renforcée \* = Versión con membrana reforzada

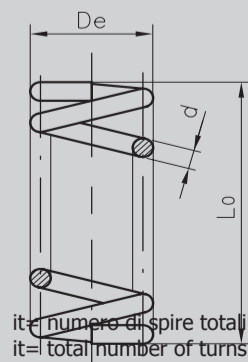

**CURVE - CURVES - COURBES - CURVAS**  
(MVSP/1 DN 15 COMPACT)

**Range 18÷70 mbar**

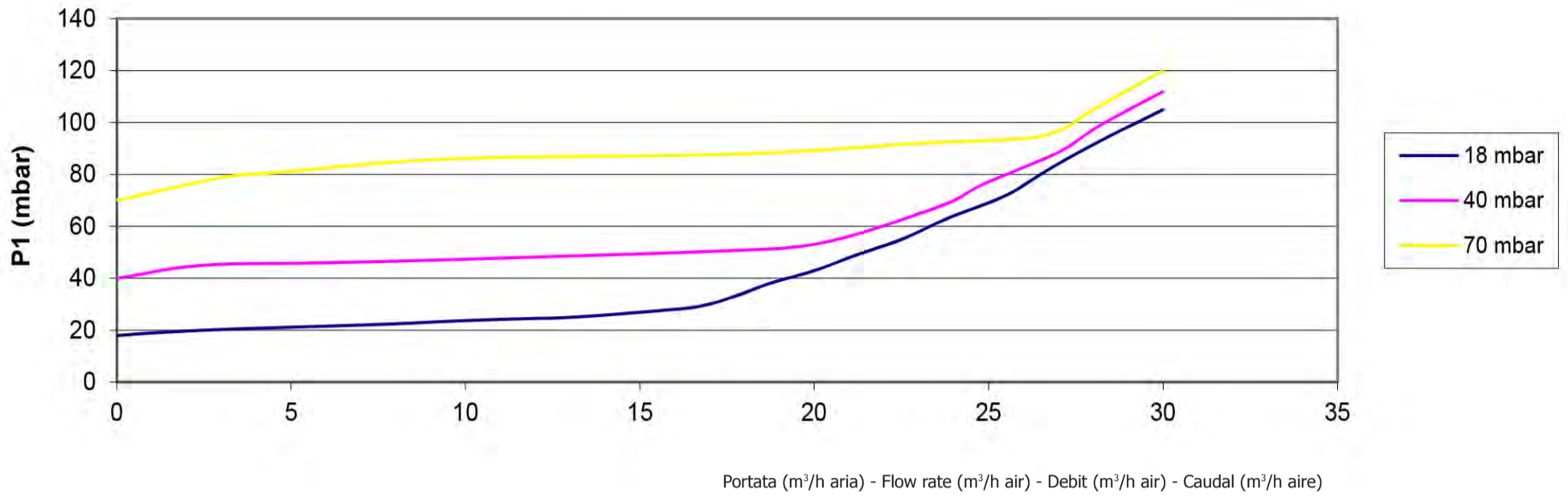

**Range 30÷120 mbar**

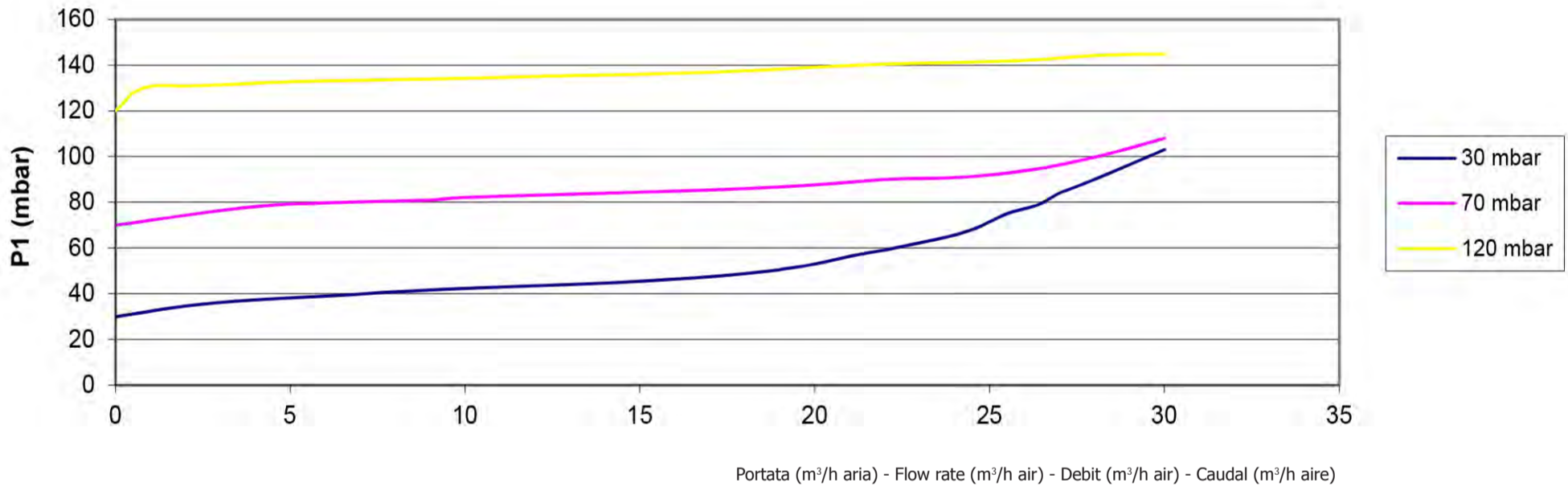

**Range 80÷260 mbar**

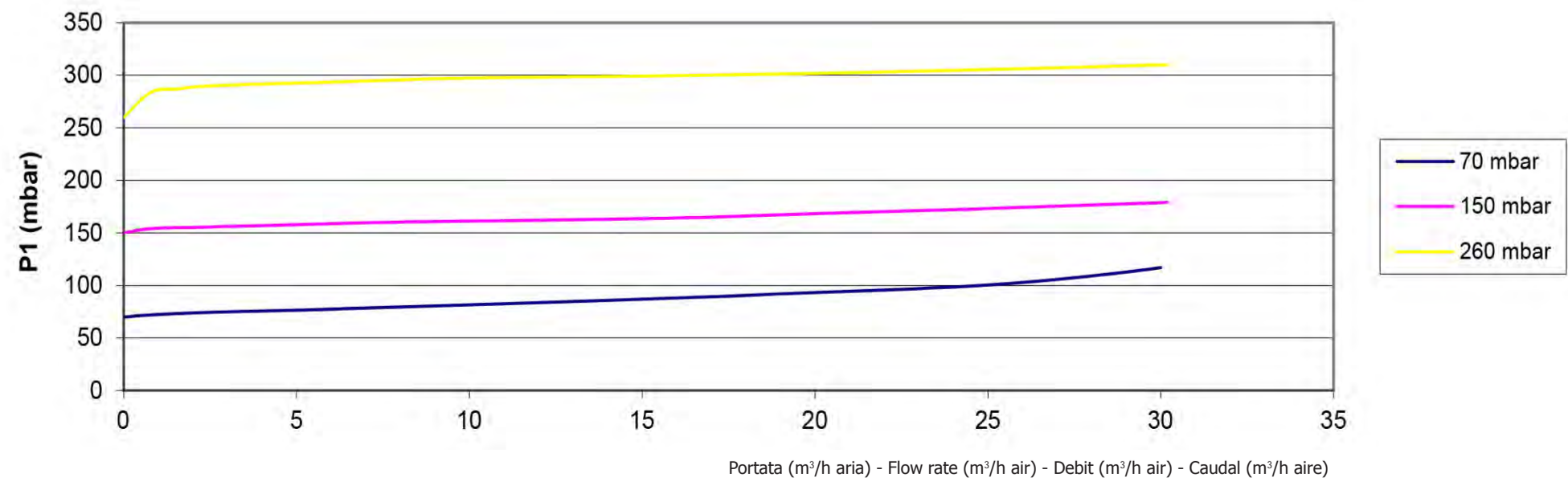



**CURVE - CURVES - COURBES - CURVAS**  
(MVSP/1 DN 25 COMPACT)

**Range 18÷80 mbar**

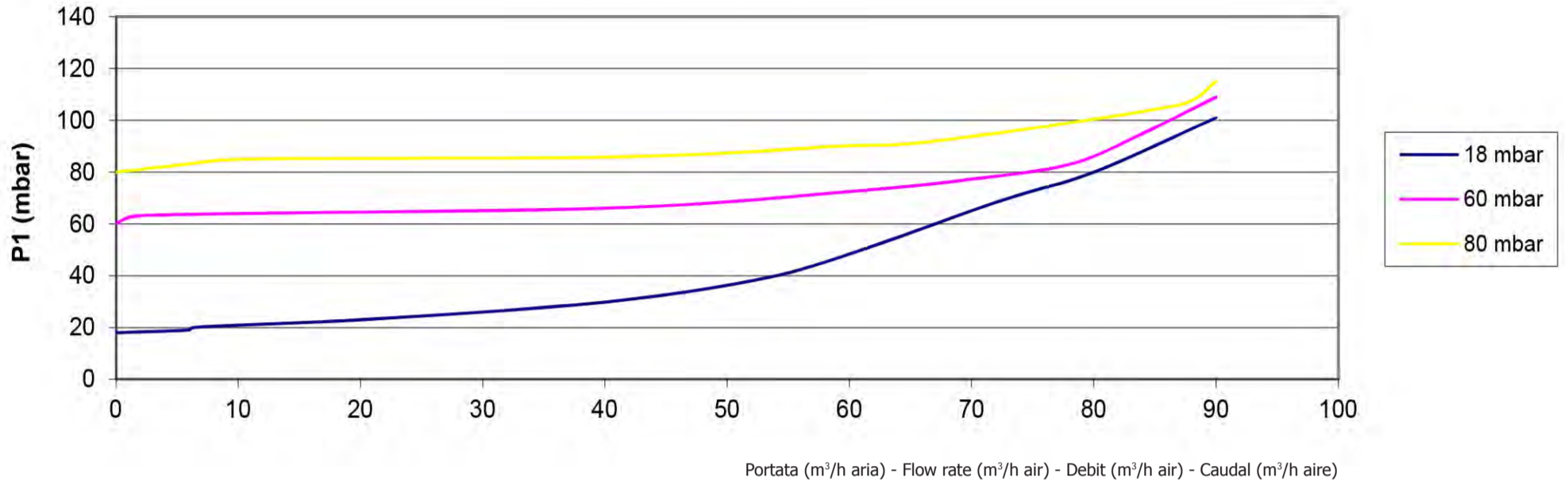

**Range 40÷160 mbar**

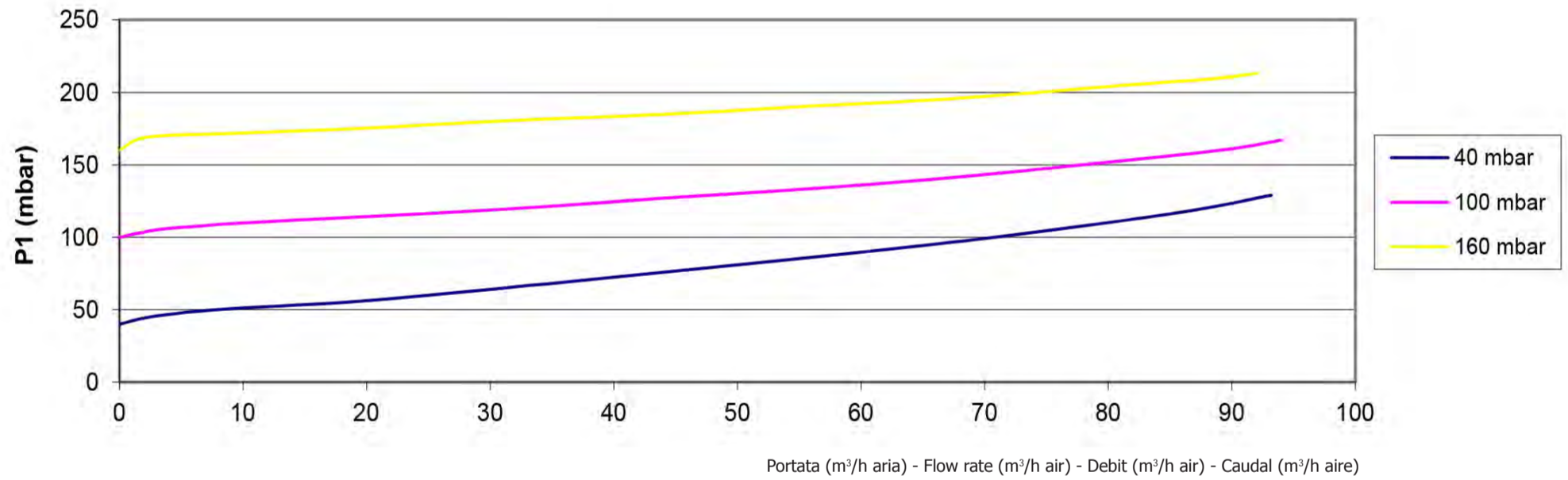

**Range 100÷300 mbar**

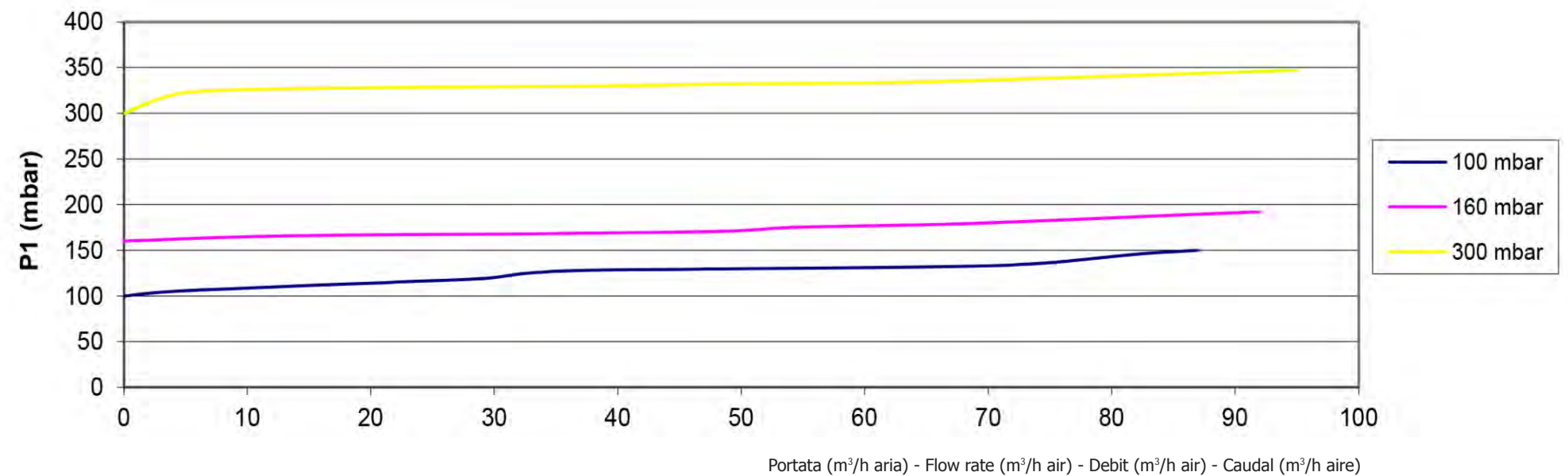

CURVE - CURVES - COURBES - CURVAS  
(MVS/1 DN 20-25 STANDARD)

Range 16÷37 mbar

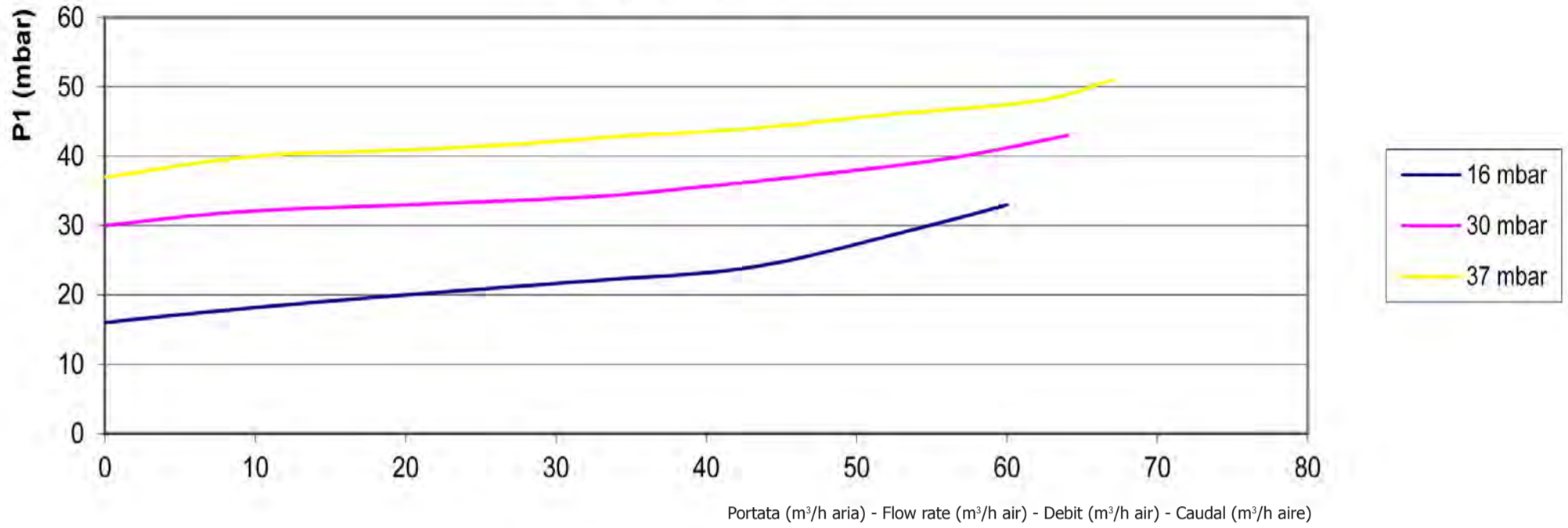

Range 30÷110 mbar

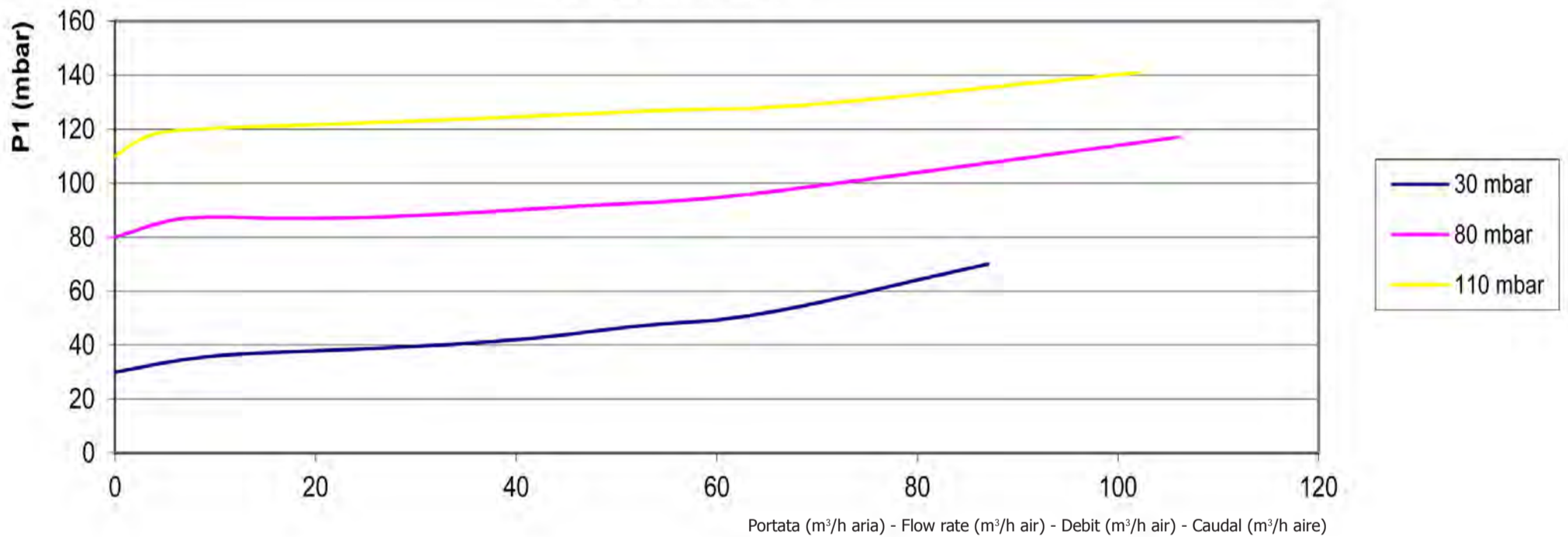

Range 100÷160 mbar

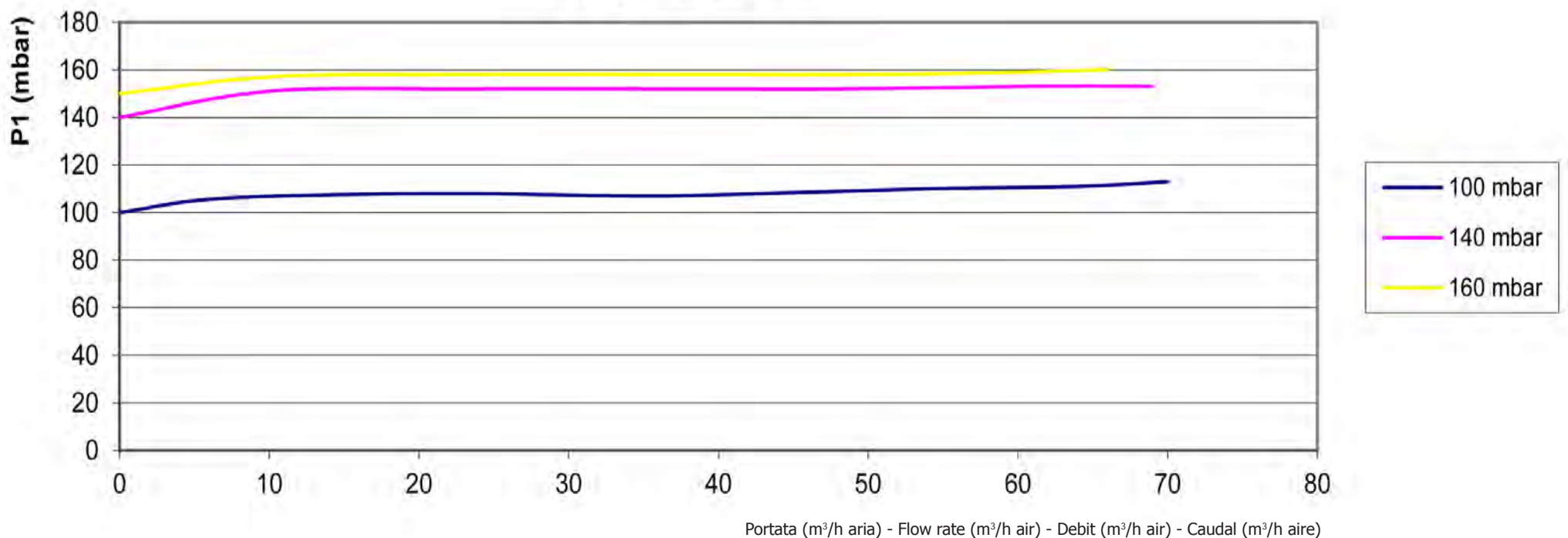

**CURVE - CURVES - COURBES - CURVAS**  
(MVS/1 DN 20-25 STANDARD)

**Range 140÷215 mbar**

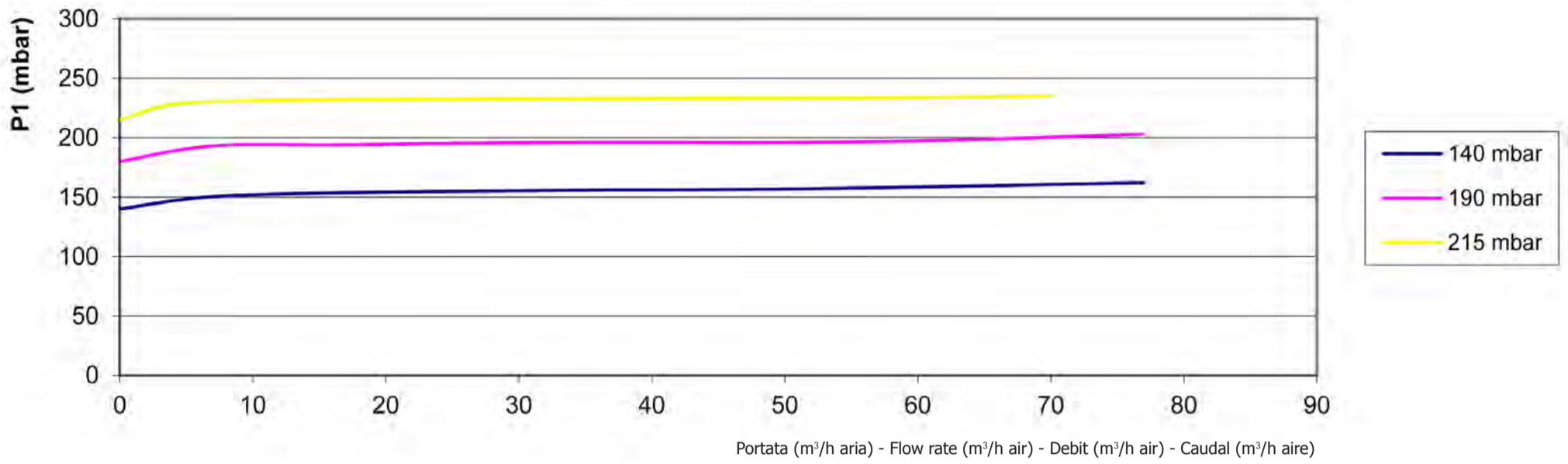

**Range 215÷500 mbar**

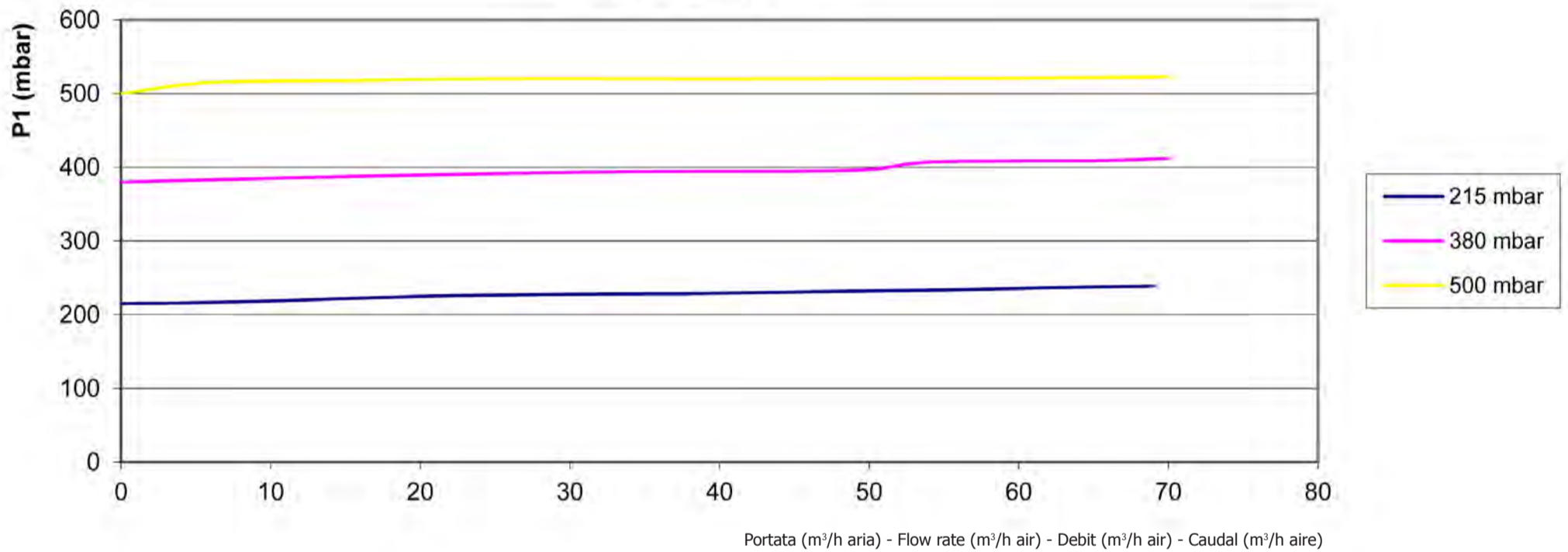

**Range 200÷1000 mbar**

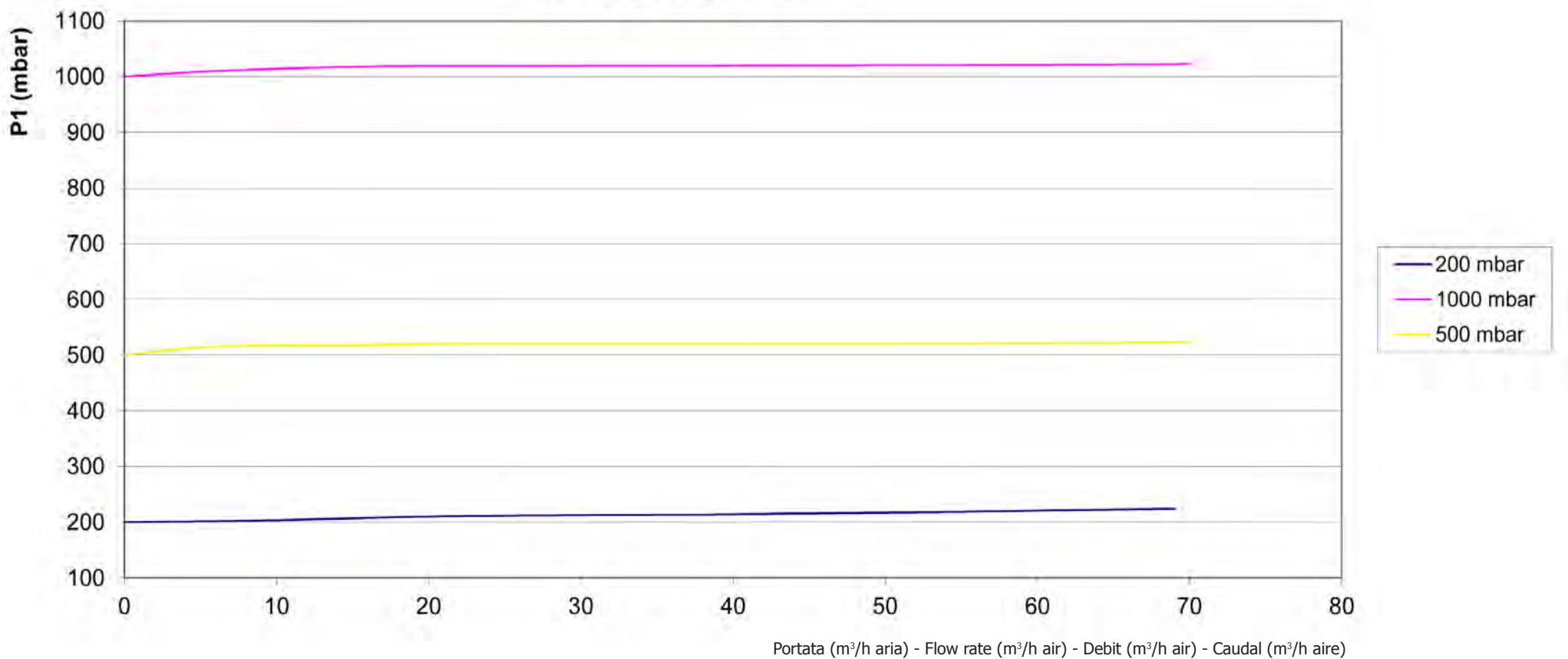



**CURVE - CURVES - COURBES - CURVAS**  
(MVS/1 DN 32-40)

**Range 30÷110 mbar**

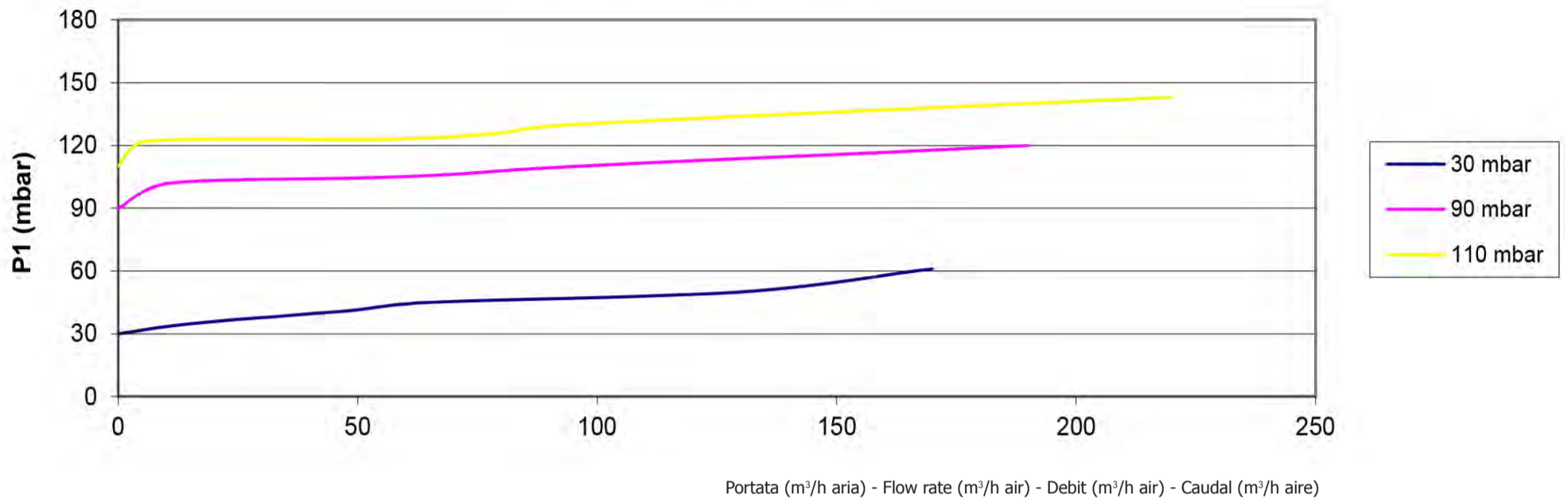

**Range 110÷170 mbar**

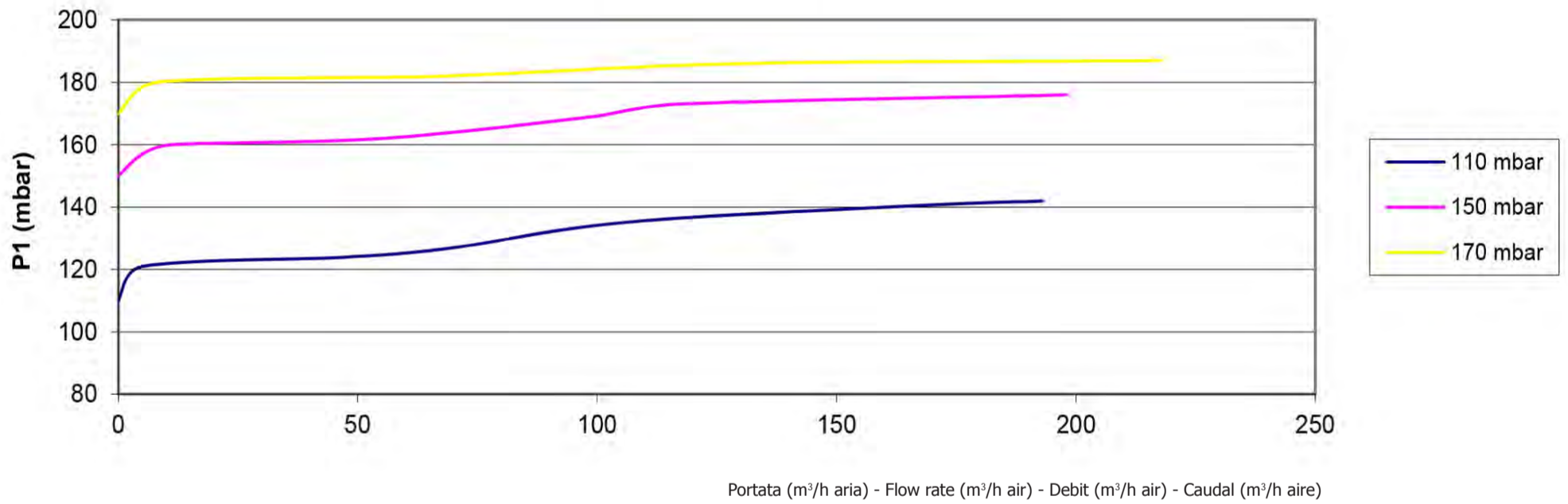

**Range 160÷300 mbar**

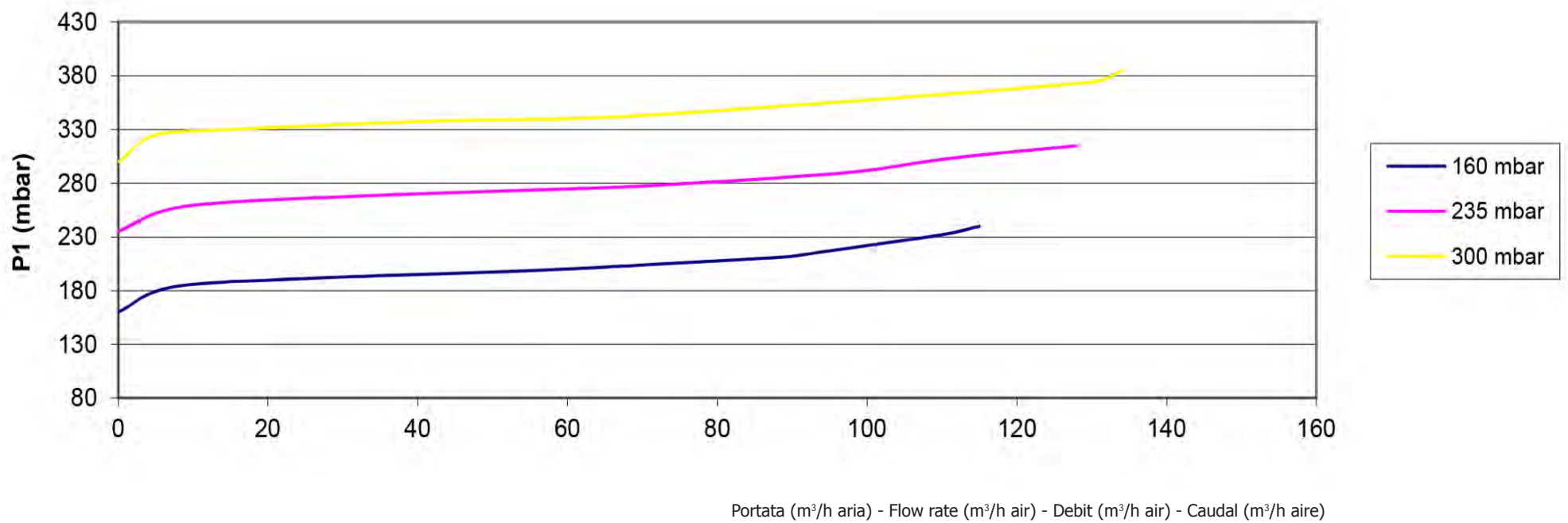

**CURVE - CURVES - COURBES - CURVAS**  
**(MVS/1 DN 50 e flangiati DN 32-40-50)**

**Range 35÷135 mbar**

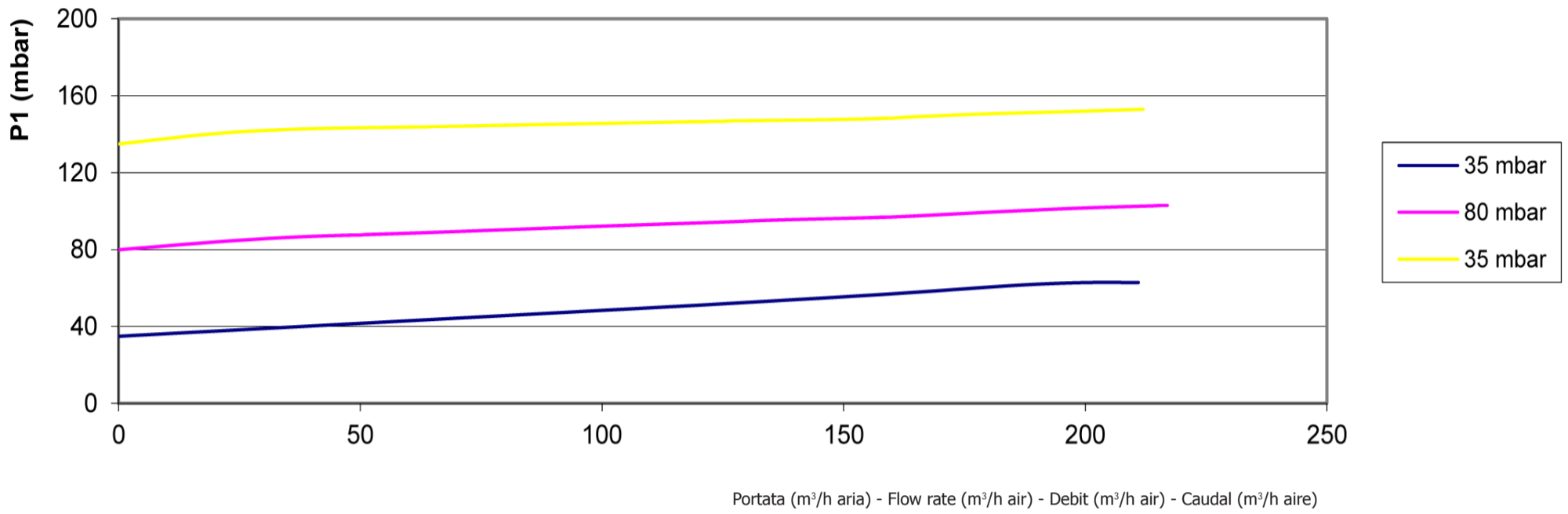

**Range 130÷200 mbar**

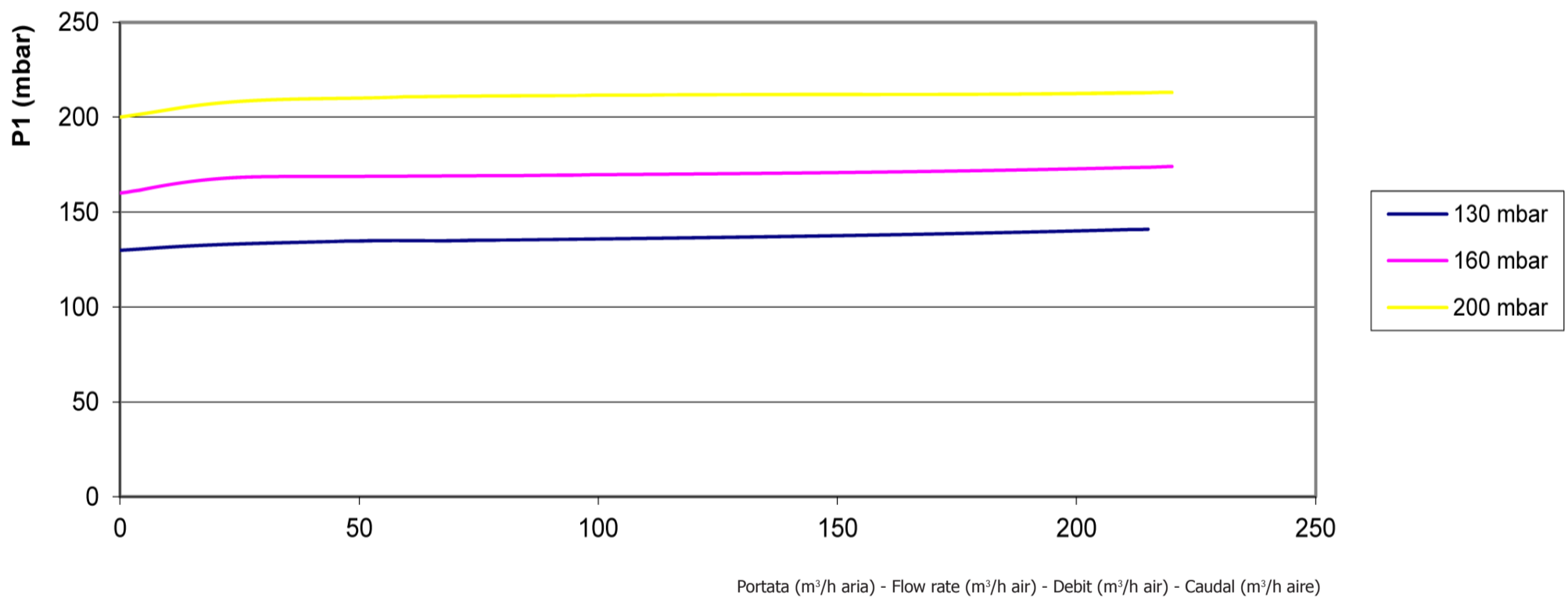



**DIMENSIONI DI INGOMBRO IN MM**  
**OVERALL DIMENSIONS IN MM**  
**MESURES D'ENCOMBREMENT EN MM**  
**DIMENSIONES EN MM**

ATTACCHI FILETTATI THREADED CONNECTIONS FIXATIONS FILETEES CONEXIONES ROSCADAS	ATTACCHI FLANGIATI FLANGED CONNECTIONS FIXATIONS BRIDEES CONEXIONES DE BRIDA	A	B	C
DN 8	-	-	81	45
DN 15 compact MVSP/1 P.max 1 bar	-	120	143	94
DN 20 compact MVSP/1 P.max 1 bar	-	120	143	94
DN 25 compact MVSP/1 P.max 1 bar	-	120	143	94
DN 20 - P. max 6 bar	-	120	147	94
DN 25 - P. max 6 bar	-	120	147	94
	DN 25 P. max 6 bar	192	180	115
DN 20		120	192	140
DN 25		120	192	140
	DN 25	192	225	140
DN 32	-	160	194	225
-	DN 32	230	285	225
DN 40	-	160	194	225
-	DN 40	230	285	225
DN 50	-	160	258	225
-	DN 50	230	285	225

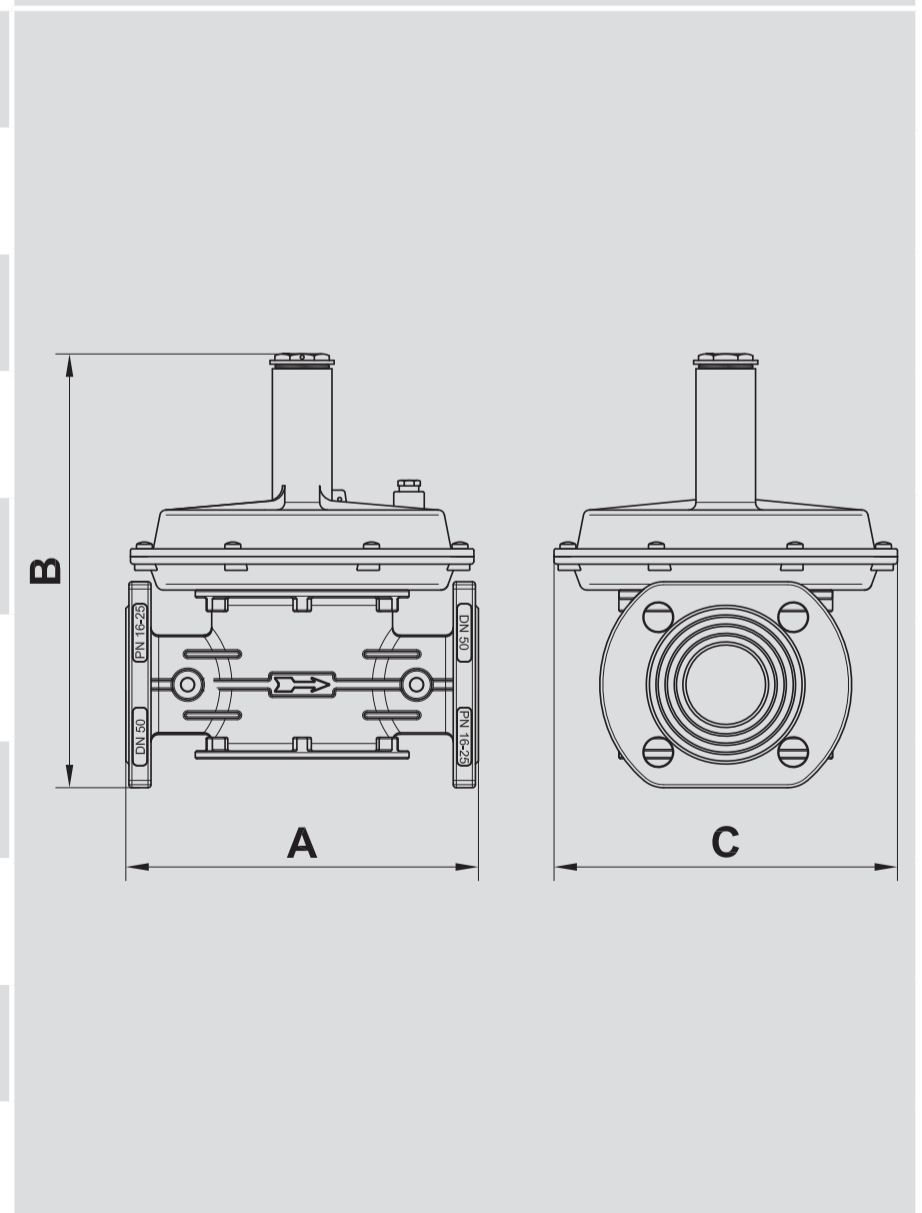
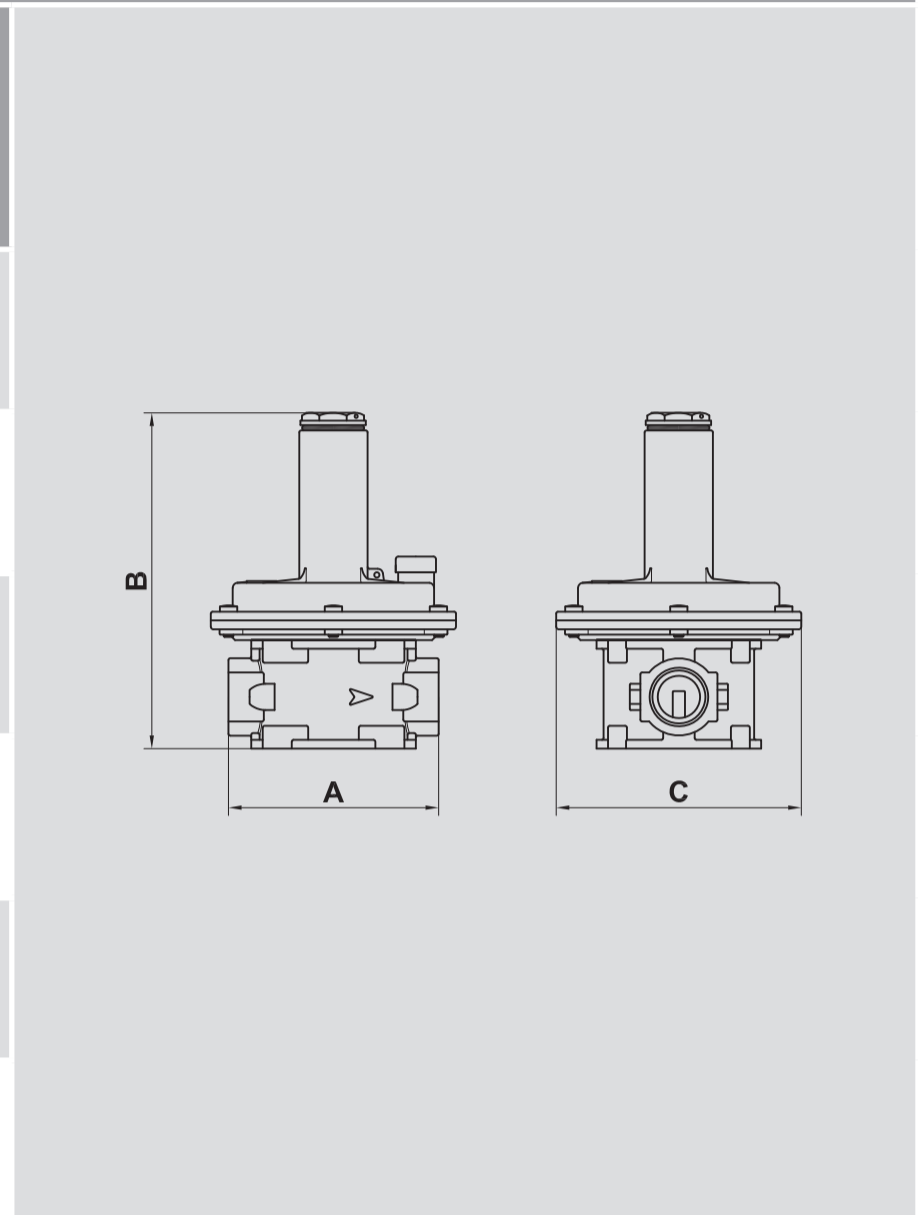



## INSTALLAZIONE

La valvola è conforme alla Direttiva Direttiva 2014/34/UE (ex 94/9/CE) come apparecchio del gruppo II, categoria 2G e come apparecchio del gruppo II, categoria 2D; come tale è idonea per essere installata nelle zone 1, 21, 2 e 22 come classificate nell'allegato I alla Direttiva 99/92/CE

La valvola non è idonea per l'utilizzo nelle zone 0 e 20 come definite nella già citata Direttiva 99/92/CE.

Per determinare la qualifica e l'estensione delle zone pericolose si veda la norma CEI EN 60079-10-1.

L'apparecchio, se installato e sottoposto a manutenzione nel pieno rispetto di tutte le condizioni e istruzioni tecniche riportate nel presente documento, non costituisce fonte di pericoli specifici: in particolare, in condizioni di normale funzionamento, è prevista, da parte della valvola, l'emissione in atmosfera di sostanza infiammabile solo occasionalmente.

La valvola può essere pericolosa rispetto alla presenza nelle sue vicinanze di altre apparecchiature solo in caso di guasto sia della membrana di funzionamento che della membrana di sicurezza: in tal caso (e solo in questo) la valvola costituisce una sorgente di emissione di atmosfera esplosiva di grado continuo e, come tale, può originare zone pericolose 0 come definite nella Direttiva 99/92/CE.

In condizioni di installazione particolarmente critiche (luoghi non presidiati, carenza di manutenzione, scarsa disponibilità di ventilazione) e, soprattutto in presenza nelle vicinanze della valvola di potenziali fonti di innesco e/o apparecchiature pericolose nel funzionamento ordinario in quanto suscettibili di originare archi elettrici o scintille, è necessario valutare preliminarmente la compatibilità fra la valvola e tali apparecchiature.

In ogni caso è necessario prendere ogni precauzione utile ad evitare che la valvola sia origine di zone 0: ad esempio verifica periodica annuale di regolare funzionamento, possibilità di modificare il grado di emissione della sorgente o di intervenire sullo scarico all'esterno della sostanza esplosiva.

A tal fine è possibile collegare all'esterno tramite un tubo di rame il foro filettato G 1/4" togliendo il tappo antipolvere in ottone.



Si raccomanda di leggere attentamente il foglio di istruzioni a corredo di ogni prodotto.

**ATTENZIONE:** le operazioni di installazione/manutenzione devono essere eseguite da personale qualificato.

- E' necessario chiudere il gas prima dell'installazione.
- Verificare che la pressione di linea **NON SIA SUPERIORE** alla pressione massima dichiarata sull'etichetta del prodotto.
- Le valvole di sfioro vengono installate a valle dei regolatori e possono essere installate in qualsiasi posizione.
- Durante l'installazione evitare che detriti o residui metallici penetrino all'interno dell'apparecchio.
- Se l'apparecchio è filettato verificare che la lunghezza del filetto della tubazione non sia eccessiva per non danneggiare il corpo dell'apparecchio in fase di avvitamento.



## INSTALLATION

The valve is in conformity with the Directive 2014/34/UE (ex 94/9/CE) as device of group II, category 2G and as device of group II, category 2D; for this reason it is suitable to be installed in the zones 1, 21, 2 and 22 as classified in the attachment I to the Directive 99/92/EC.

The valve is not suitable to be used in zones 0 and 20 as classified in the already said Directive 99/92/EC.

To determine the qualification and the extension of the dangerous zones, see the norm CEI EN 60079-10-1.

The device, if installed and serviced respecting all the conditions and the technical instructions of this document, is not source of specific dangers: in particular, during the normal working, is forecast, by the solenoid valve, the emission in the atmosphere of inflammable substance only occasionally.

The valve can be dangerous as regards to the presence close to it of other devices only in case of damage either of the working diaphragm or of the safety one: only in this case the valve is a source of emission of the continue degree explosive atmosphere and, so, it can originate dangerous areas 0 as defined in the 99/92/EC Directive.

In conditions of particularly critic installation (places not protected, lack of servicing, lacking availability of ventilation) and, especially in presence, close to the valve, of potential sources of primer and/or dangerous devices during the normal working because susceptible to origine electric arcs or sparks, it is necessary to value before the compatibility between the valve and these devices.

In any case it is necessary to take any useful precaution to avoid that the valve could be origin of areas 0: for example yearly periodical inspection of regular working, possibility to change the emission degree of the source or to attend on the exhaust outside the explosive material.

To do so it is possible to connect outside by a copper pipe the threaded hole G 1/4" removing the brass anti-dust cap.



It is always important to read carefully the instruction sheet of each product.

**WARNING:** all installation/maintenance work must be carried out by skilled staff.

- The gas supply must be shut off before installation.
- Check that the line pressure **DOES NOT EXCEED** the maximum pressure stated on the product label.
- The relief valves are installed downstream the regulators and can be installed in any position.
- During installation take care not to allow debris or scraps of metal to enter the device.
- If the device is threaded check that the pipeline thread is not too long; overlong threads may damage the body of the device when screwed into place.



## INSTALLATION

La vanne est conforme à la Directive 2014/34/UE (ex 94/9/CE) comme appareil du groupe II, catégorie 2G et comme appareil du groupe II, catégorie 2D; comme telle elle est peut être installée dans les zones 1, 21, 2 et 22 comme classées dans l'annexe I de la Directive 99/92/CE.

La vanne n'est pas adaptée pour l'utilisation dans les zones 0 et 20 comme définies dans la Directive 99/92/CE déjà citée.

Pour déterminer la qualification et l'extension des zones dangereuses, se reporter à la norme CEI EN 60079-10-1.

L'appareil, s'il est installé et soumis à entretien en respectant toutes les conditions et les instructions techniques reportées dans ce document, n'est pas une source de dangers spécifiques: en particulier, au cours du fonctionnement normal, il est prévu que la vanne émette dans l'atmosphère une substance inflammable seulement occasionnellement.

La vanne peut être dangereuse à cause de la présence d'autres appareils à proximité seulement en cas de panne aussi bien de la membrane de fonctionnement que de celle de sécurité: uniquement dans ce cas la vanne est une source d'émission d'atmosphère explosive de degré continu et, comme telle, peut engendrer des zones dangereuses 0 comme définies dans la Directive 99/92/CE.

Dans des conditions d'installation particulièrement critique (lieux non contrôlés, manque d'entretien, faible ventilation) et surtout en présence à proximité de la vanne de sources potentielles d'amorçage et/ou d'appareils dont le fonctionnement ordinaire est dangereux car ils sont susceptibles de provoquer des arcs électriques ou des étincelles, évaluer préalablement la compatibilité entre la vanne et ces appareils.

De toute façon il faut prendre toutes les précautions nécessaires afin d'éviter que la vanne engendre des zones 0: par exemple, vérification annuelle du bon fonctionnement, possibilité de modifier le degré d'émission de la source ou d'intervenir sur l'évacuation à l'extérieur de la substance explosive.

Pour cela il est possible de raccorder à l'extérieur par l'intermédiaire d'un tuyau en laiton le trou fileté G 1/4" en enlevant le bouchon anti-poussière en laiton.



Lire attentivement les instructions pour chaque produit.

**ATTENTION:** les opérations d'installation/entretien doivent être exécutées par du personnel qualifié.

- Fermer le gaz avant l'installation.
- Vérifier que la pression de ligne **NE SOIT PAS SUPÉRIORE** à la pression maximum déclarée sur l'étiquette du produit.
- Les soupapes d'effleurment sont installées en bas des régulateurs et peuvent être installées dans l'importe quelle position.
- Pendant l'installation, éviter que des débris ou des résidus métalliques pénètrent dans l'appareil.
- Si l'appareil est fileté, vérifier que le filet de la tuyauterie ne soit pas trop long pour ne pas endommager le corps de l'appareil lors du vissage.



## INSTALACIÓN

La válvula es conforme a la Directiva 2014/34/UE (ex 94/9/CE) como aparato del grupo II, categoría 2G y como aparato del grupo II, categoría 2D; como tal, resulta adecuada para su instalación en las zonas 1, 21, 2 y 22, según están clasificadas en el documento adjunto I a la Directiva 99/92/CE.

La válvula no es adecuada para la utilización en las zonas 0 y 20, según se definen en la citada Directiva 99/92/CE.

Para determinar la calificación y extensión de las zonas peligrosas, ver la norma CEI EN 60079-10-1.

El aparato, si se instala y somete a mantenimiento respetando todas las condiciones e instrucciones técnicas referidas en el presente documento, no da lugar a riesgos particulares: concretamente, en condiciones de funcionamiento normales, la electroválvula provoca la emisión a la atmósfera de sustancias inflamables sólo accidentalmente.

La válvula puede ser peligrosa, si se da la presencia en sus inmediaciones de otros aparatos, únicamente en caso de avería de la membrana de funcionamiento o de la membrana de seguridad: en tal caso (y sólo en ese caso) la válvula constituye una fuente de emisión de atmósfera explosiva de grado continuo y, como tal, puede originar zonas peligrosas 0, según la definición de la Directiva 99/92/CE.

En condiciones de instalación especialmente críticas (lugares no vigilados, falta de mantenimiento, escasa ventilación) y, sobre todo, si se da la presencia en las inmediaciones de la válvula de potenciales fuentes de encendido y/o aparatos peligrosos en el funcionamiento ordinario, por ser susceptibles de originar arcos eléctricos o chispas, habrá que valorar previamente la compatibilidad entre la válvula y dichos aparatos.

En cualquier caso será necesario tomar toda clase de precaución encaminada a evitar que la válvula pueda dar origen a zonas 0: por ejemplo, habrá que verificar con periodicidad anual su buen funcionamiento y contemplar la posibilidad de modificar el grado de emisión de la fuente o de intervenir en la emisión al exterior de la sustancia explosiva. Para ello, el orificio roscado G 1/4", quitando el tapón antipolvo de latón, se puede conectar al exterior a través de un tubo de cobre.



Se recomienda leer atentamente la hoja de instrucciones adjuntas con el producto.

**ATENCIÓN:** las operaciones de instalación, y mantenimiento deben ser efectuadas por personal cualificado.

- Antes de iniciar las operaciones de instalación es necesario cerrar el gas.
- Verificar que la presión de la línea **NO SEA SUPERIOR** a la presión máxima indicada en la etiqueta del producto.
- Las válvulas de alivio se instalan aguas abajo de los reguladores y en cualquier posición.
- Durante la instalación prestar atención a fin de evitar que detritos o residuos metálicos se introduzcan en el aparato.
- En el caso de aparato roscado será necesario verificar que la longitud de la rosca de la tubería no sea excesiva dado que, durante el enroscado, podría provocar daños en el cuerpo del aparato mismo.



• Se l'apparecchio è flangiato verificare che le controflange di ingresso e uscita siano perfettamente parallele per evitare di sottoporre il corpo a inutili sforzi meccanici, calcolare inoltre lo spazio per l'inserimento della guarnizione di tenuta. Se a guarnizioni inserite lo spazio rimanente è eccessivo non cercare di colmarlo stringendo eccessivamente i bulloni dell'apparecchio.

• In ogni caso dopo l'installazione verificare la tenuta dell'impianto.



• If the device is flanged check that the inlet and outlet counterflanges are perfectly parallel to avoid unnecessary mechanical stresses on the body of the device. Also calculate the space needed to fit the seal. If the gap left after the seal is fitted is too wide, do not try to close it by over-tightening the device's bolts.

• Always check that the system is gas-tight after installation.



• Si l'appareil est bridé, vérifier que les contre-brides d'entrée et de sortie soient parfaitement parallèles pour éviter de soumettre le corps à des efforts mécaniques inutiles; par ailleurs, calculer l'espace pour l'introduction du joint d'étanchéité. Si, lorsque les joints sont introduits, l'espace restant est excessif, ne pas essayer de le combler en serrant trop fort les boulons de l'appareil.

• De toute façon, après l'installation vérifier l'étanchéité de l'installation.



• En el caso de aparato embridado, será necesario controlar que las contrabridas de entrada y de salida queden perfectamente paralelas a fin de evitar que el cuerpo quede sometido a fuerzas mecánicas inútiles. Calcular además el espacio para la introducción de la junta de estanqueidad. Si una vez introducidas las juntas el espacio restante es excesivo, no apretar demasiado los pernos del aparato para intentar reducirlo.

• De todas formas, verificar la estanqueidad del sistema una vez efectuada la instalación.

**ESEMPIO DI INSTALLAZIONE**

1. Valvola a strappo SM
2. Filtro gas serie FM
3. Valvola di blocco MVB/1 MAX o MIN
4. Regolatore gas serie RG/2MC
5. **Valvola di sfioro MVS/1**
6. Leva comando a distanza valvola a strappo SM

**EXAMPLE OF INSTALLATION**

1. SM series jerk handle ON/OFF valve
2. FM series gas filter
3. MVB/1 MAX or MIN shut off valve
4. RG/2MC series pressure regulator
5. **MVS/1 overflow valve**
6. Lever for remote SM ON/OFF valve control

**EXEMPLE D'INSTALLATION**

1. Soupape à déchirement SM
2. Filtre gaz série FM
3. Soupape de bloc MVB/1 MAX ou MIN
4. Régulateur gaz série RG/2MC
5. **Soupape d'effleurement MVS/1**
6. Levier de commande à distance soupape à déchirement SM

**EJEMPLO DE INSTALACIÓN**

1. Válvula de corte SM
2. Filtro gas serie FM
3. Válvulas de bloqueo MVB/1 MAX o MIN
4. Regulador gas serie RG/2MC
5. **Válvula de alivio MVS/1**
6. Palanca para actuación de de la válvula de corte SM

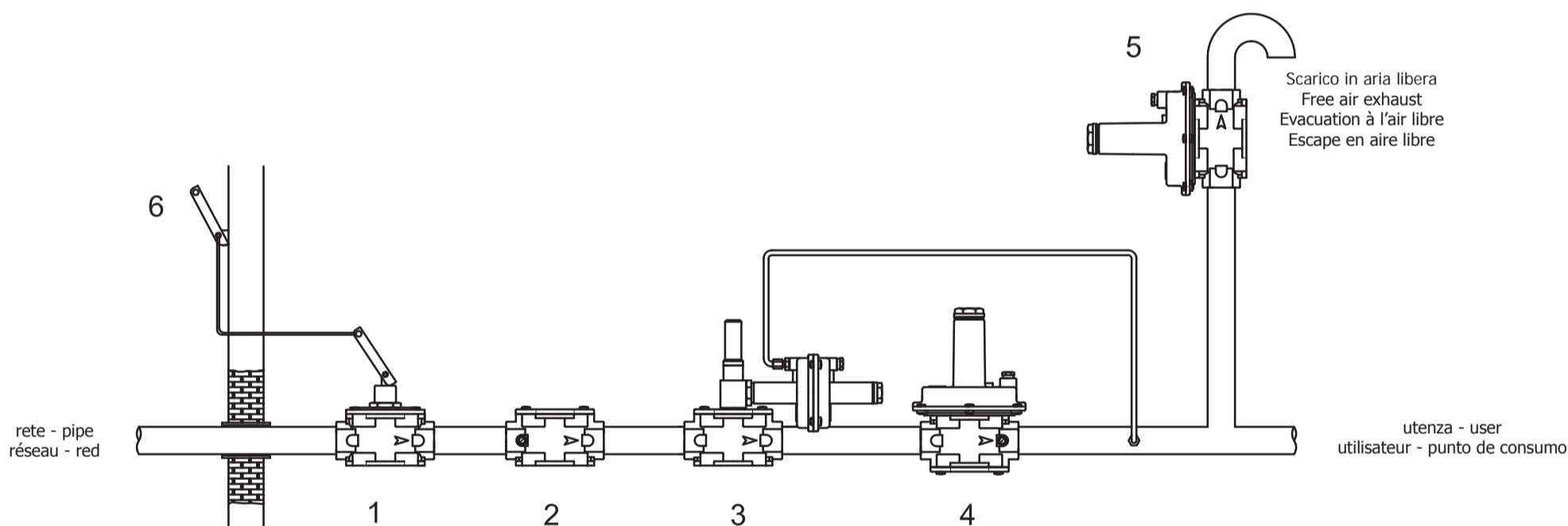
**TARATURA**

Esempio di taratura per una valvola di sfioro installata a valle di un regolatore RG/2MC:

- pressione uscita regolatore: 20 mbar
- taratura valvola di blocco: 50 mbar
- occorre tarare la valvola di sfioro a 40 mbar

Procedere nel seguente modo (vedi fig. 3):

Avvitare al massimo la vite di regolazione (2), regolare la pressione di uscita del regolatore (per mezzo dell'apposita vite di regolazione) al valore di pressione di sfioro voluta (in questo caso 40 mbar), svitare la vite di regolazione (2) della valvola di sfioro finché quest'ultima inizia a sfiorare. A questo punto la valvola è tarata, ripristinare quindi il valore di taratura del regolatore (in questo caso 20 mbar).

**CALIBRATION**

Example a calibration of an overflow valve installed downstream a RG/2MC regulator:

- regulator outlet pressure: 20 mbar
- setting closing valve: 50 mbar
- the overflow valve must be set at 40 mbar

Proceed as follows (see fig. 3):

Screw at maximum the regulation screw (2), then set the output regulator pressure (by the setting screw) to the needed overflow pressure value (in this case 40 mbar), unscrew the regulation screw (2) of the overflow valve as long as it starts to exhaust. Then restore the regulator setting value (in this case 20 mbar).

**TARAGE**

Exemple de tarage pour une soupape d'effleurement installée en bas d'un régulateur RG/2MC:

- pression sortie régulateur: 20 mbar
- tarage soupape de bloc: 50 mbar
- il faut tarer la soupape d'effleurement à 40 mbar

Procéder de façon suivante (voir fig. 3):

Visser au maximum la vis de réglage (2), régler la pression de sortie du régulateur (au moyen de la vis de réglage spéciale) à la valeur de pression d'effleurement voulue (dans ce cas 40 mbar), dévisser la vis de réglage (2) de la soupape d'effleurement jusqu'à ce que cette dernière commence à effleurer. A ce stade la soupape est tarée, rétablir la valeur de tarage du régulateur (dans ce cas 20 mbar).

**TARADO**

Ejemplo de tarado para una válvula de alivio instalada aguas abajo de un regulador RG/2MC:

- presión salida regulador: 20 mbar
- tarado válvula de bloqueo: 50 mbar
- es necesario tarar la válvula de alivio a 40 mbar

Proceder en el siguiente modo (véanse fig. 3):

Atornillar al máximo el tornillo de regulación (2), regular la presión de salida del regulador (por el apropiado tornillo de regulación) al valor de presión de alivio deseado (en este caso 40 mbar), destornillar el tornillo de regulación (2) de la válvula de alivio hasta que esta empiece a salir. Ahora la válvula está tarada, restablecer el valor de tarado del regulador (en este caso 20mbar).



**MANUTENZIONE** (vedi fig. 3)

In caso di necessità, per controllare l'integrità degli elementi interni della valvola, procedere nel seguente modo:

svitare il tappo di chiusura (1) e la vite di regolazione (2) e sfilare la molla di taratura (14).

Dopo aver svitato le viti di fissaggio (12), togliere l'imbuto (15), sfilare la membrana di sicurezza (5) e l'otturatore (7) verificando l'integrità della membrana (11) e della guarnizione di tenuta (9), se necessario effettuare la sostituzione.

Procedere quindi al montaggio facendo a ritroso l'operazione di smontaggio.



Le suddette operazioni devono essere eseguite esclusivamente da tecnici qualificati.



**SERVICING** (see fig. 3)

If necessary to check the valve seal component proceed as follows:

unscrew the closing cap (1) and the setting screw (2) then take off the setting spring (14).

After unscrewing the fixing screws (12) take off the funnel (15) the safety diaphragm (5) and the obturator (7) and check that the diaphragm (11) and the seal component (9) are good. If necessary substitute them.

Reassemble doing backward the same operation.



The above-said operations must be carried out only by qualified technicians.



**MANUTENTION** (voir fig. 3)

En cas de nécessité, pour contrôler l'intégrité des éléments internes de la soupape, procéder de façon suivante:

dévisser le bouchon de fermeture (1) et la vis de réglage (2) et enlever le ressort de tarage (14).

Après avoir dévisser les vis de fixation (12), enlever l'entonnoir (15), enlever la membrane de sécurité (5) et l'obturateur (7) en vérifiant l'intégrité de la membrane (11) et de la garniture de tenue (9), si nécessaire effectuer la substitution.

Procéder ensuite au remontage en faisant les opérations inverses.



Les opérations mentionnées ci-dessus doivent être exécutées exclusivement par des techniciens qualifiés.



**MANTENIMIENTO** (véanse fig. 3)

Si necesario, para controlar la integridad de los elementos internos de la válvula, proceder así:

destornillar el tapón de cierre (1) y el tornillo de regulación (2) y soltar el muelle de tarado (14).

Después de haber destornillado los tornillos de fijación (12), quitar el embudo (15), soltar la membrana de seguridad (5) y el obturador (7) verificando la integridad de la membrana (11) y de la arandela de estanquidad (9), si necesario efectuar la sustitución.

Proceder al montaje realizando el proceso inverso.



Las operaciones antes indicadas deben ser ejecutadas únicamente por técnicos cualificados.