

# THE POWER IS YOURS!

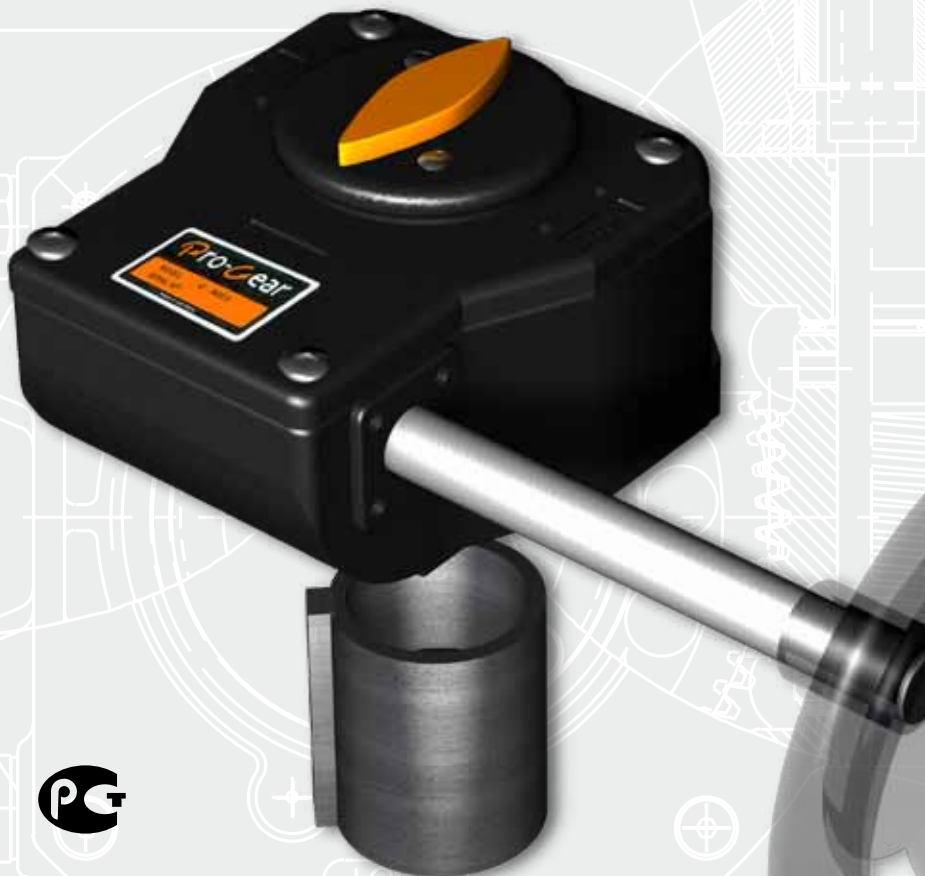

## Q SERIES

- HOUSING
- INPUT SHAFT
- QUADRANT
- WORM
- STROKE ADJUSTMENT
- INDICATOR
- COATING





# Q SERIES

The Pro-Gear Series “Q” quarter turn gearboxes are rugged, industrial grade products, manufactured with cast iron housing and components. All models in this series feature high performance bearings and a powder coated finish.

## APPLICATIONS

The Q series is highly suitable for all general industrial applications as well as applications in chemical, power, HVAC and waterworks. Pro-Gear’s operators are intended for the operation of ball, plug and butterfly valves as well as power and process dampers. The usage of high grade of materials provides a tough, reliable unit for the automation of today’s high performance industrial valves. Several options such as padlocking devices, memory stops, spur gears and limit switchboxes can be easily mounted on site without any machining, due to the integration of all necessary connections on the housing.



## PERFORMANCE SPECIFICATIONS

- > 14 Models
- > Up to 70.000 Nm. Torque range
- > -5° to 95° stroke
- > IP68 sealing
- > -25 °C to +110 °C (-13 °F to +230 °F) temperature range

TYPE	RATIO	TORQUE (Nm)		M.A. ± 10%	WEIGHT (Kg)
		OUTPUT	INPUT		
Q-200 S	40 : 1	200	16.8	11.9	2
Q-400 S	44 : 1	400	31.25	12.8	3.87
Q-800 S	40 : 1	800	60	13.3	7.68
Q-1500 S	42 : 1	1500	122.95	12.2	13.50
Q-2000 S	48 : 1	2000	131	15.3	14.55
Q-3000 S	62 : 1	3000	167	17.9	22.8
Q-4000 S	72 : 1	4000	185	21.6	31.5
Q-6500 S	267 : 1	6500	95	68.4	37.50
Q-12000 S	267 : 1	12000	168.48	71.2	56.70
Q-16000 S	648 : 1	16000	120	133.3	62.50
Q-24000 S	720 : 1	24000	140	171.4	192
Q-32000 S	960 : 1	32000	140	228.6	195
Q-50000 S	960 : 1	50000	150	333.3	352
Q-70000 S	1280 : 1	70000	185	378.4	352

1Nm=0,737562 lbf.ft. 1Nm=8,8507 lbf.ins. [Converting International Units to British Units]

## FEATURES

- > Stainless Steel input shaft
- > Stainless Steel fasteners
- > Standardised according to DIN / ISO 5211
- > 13 Models up to 70.000 Nm. output
- > Axial needle bearings
- > NBR 70 gasket material
- > Sealed position-indicator
- > Powder coated / polyurethane coated finish
- > Insert bush system for flexibility and reduced lead times (interchangeable with X-series inserts)
- > Carefully chosen ratio’s are increasing the MA-rates
- > Blind tapped PCD’s



**PARTS / MATERIALS LIST Q SERIES**

PART NO	DESCRIPTION	MATERIAL	SPECS / STANDARD
1	Body	Cast-iron / Ductile iron	GG25/ASTM A48
2	Coverplate	Cast-iron	GG25/ASTM A48
3	Pos. Indicator	Cast-iron	GG25/ASTM A48
4	Quadrant	Ductile-iron	GGG40 / ASTM A356
5	Worm	Carbon steel	C45-K
6	Shaft	Stainless steel	
7	Axial needle bearing		
8	Gasket	Nitrile/silicone	NBR-70° shore
9	O-rings	Nitrile	NBR-70° shore
10	Grease	Complex EP-0	DIN KG0G0.5N-30 ISO-LXCD1B0.5
11	Fasteners	Stainless steel	

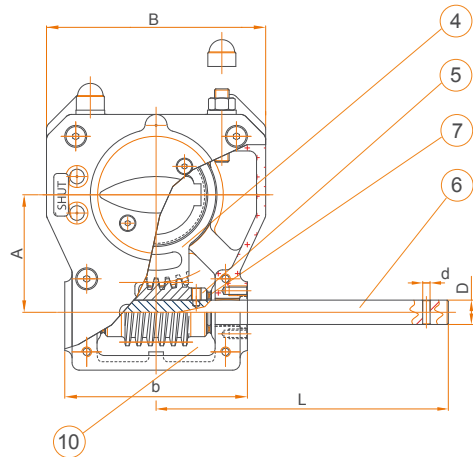
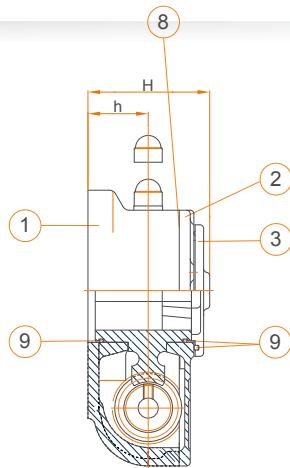
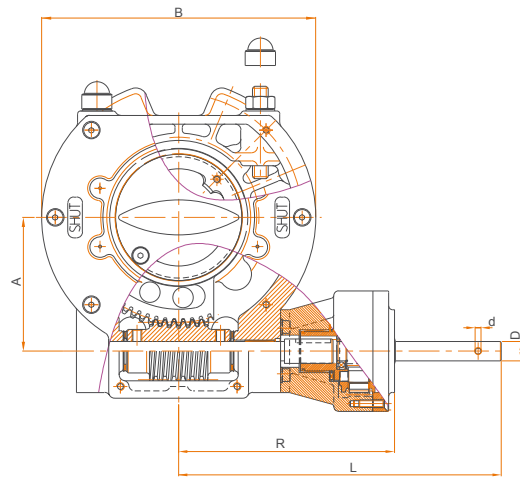

GEARBOX	TYPE	A	b	B	d	D	h	H	L	R	VALVE CONNECTION ACC ISO 5211			
0-200 S	MM	43.5	70	84	4	12	28.5	64	118	-	50 (F05)	70 (F07)		
	INCH	1.71	2.76	3.31	0.16	0.47	1.12	2.52	4.65	-	1.97	2.76		
0-400 S	MM	52.5	91	112	4	12	34	74.75	175	-	70 (F07)	102 (F10)		
	INCH	2.07	3.58	4.41	0.16	0.47	1.34	2.94	6.89	-	2.76	4.02		
0-800 S	MM	68.75	110	135	5	15	42.5	90.5	225	-	102 (F10)	125 (F12)	140 (F14)	
	INCH	2.71	4.33	5.31	0.20	0.59	1.67	3.56	8.86	-	4.02	4.92	5.51	
0-1500 S	MM	84	129	156	6	20	45	97	214	-	102 (F10)	125 (F12)	140 (F14)	
	INCH	3.31	5.08	6.14	0.24	0.79	1.77	3.82	8.43	-	4.02	4.92	5.51	
0-2000 S	MM	96.5	150	180	6	20	50	100	240	-	102 (F10)	125 (F12)	140 (F14)	165 (F16)
	INCH	3.80	5.91	7.09	0.24	0.79	1.97	3.94	9.45	-	4.02	4.92	5.51	6.50
0-3000 S	MM	117.5	201	250	6	20	48.5	117.5	255	-	140 (F14)	165 (F16)		
	INCH	4.63	7.91	9.84	0.24	0.79	1.91	4.63	10.04	-	5.51	6.50		
0-4000 S	MM	137.5	210	282	6	20	54.5	128	300	-	165 (F16)	254 (F25)		
	INCH	5.41	8.27	11.10	0.24	0.79	2.15	5.04	11.81	-	6.50	10.00		
0-6500 S	MM	137.5	210	282	6	20	54.5	128	347	222	165 (F16)	254 (F25)		
	INCH	5.41	8.27	11.10	0.24	0.79	2.15	5.04	13.66	8.74	6.50	10.00		
0-12000 S	MM	180	272	366	6	20	63.5	135	378	282	254 (F25)	298 (F30)		
	INCH	7.09	10.71	14.41	0.24	0.79	2.50	5.31	14.88	11.10	10.00	11.73		
0-16000 S	MM	180	272	366	8	25	63.5	135	403	326	254 (F25)	298 (F30)		
	INCH	7.09	10.71	14.41	0.31	0.98	2.50	5.31	15.87	12.83	10.00	11.73		
0-24000 S	MM	252.5	350	510	8	25	85	186	442	365	254 (F25)	298 (F30)	356 (F35)	406 (F40)
	INCH	9.94	13.78	20.08	0.31	0.98	3.35	7.32	17.40	14.37	10.00	11.73	14.02	15.98
0-32000 S	MM	252.5	350	510	8	25	85	186	442	365	254 (F25)	298 (F30)	356 (F35)	406 (F40)
	INCH	9.94	13.78	20.08	0.31	0.98	3.35	7.32	17.40	14.37	10.00	11.73	14.02	15.98
0-50000 S	MM	291.5	540	612	key 8mm	25	138	262.5	612	502	356 (F35)	406 (F40)	483 (F48)	
	INCH	11.48	21.26	24.09	0.31" key	0.98	5.43	10.33	24.09	19.76	14.02	15.98	19.02	
0-70000 S	MM	291.5	540	612	key 8mm	25	138	262.5	612	502	356 (F35)	406 (F40)	483 (F48)	
	INCH	11.48	21.26	24.09	0.31" key	0.98	5.43	10.33	24.09	19.76	14.02	15.98	19.02	

## HANDWHEELS "P(PRESSED)-SERIES"

TYPE	D	H
P100	Ø 100	38
P125	Ø 125	42
P160	Ø 160	48
P200	Ø 200	53

Dimensions mentioned in mm.

## HANDWHEELS "W(ELDED)-SERIES"

TYPE	D	H
W125	Ø 125	50.5
W160	Ø 160	56
W200	Ø 200	73
W250	Ø 250	86
W300	Ø 300	86
W400	Ø 400	122
W500	Ø 500	141
W600	Ø 600	157
W700	Ø 700	180

Dimensions mentioned in mm.

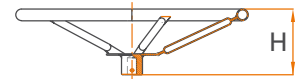
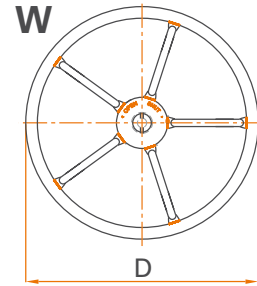
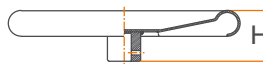
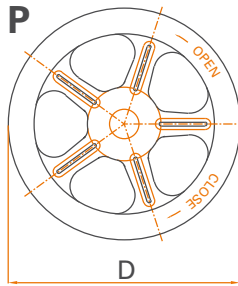

How to size the diameter of the handwheel:

- 1 Get the output torque required

$$\text{Handwheel diameter} = \left( \frac{\text{Output Required}}{\text{M.A.}} \right) \times 5^*$$

- 2 Select the Handwheel diameter

\* RIM pull 400 Nm

## THE POWER IS YOURS!

Pro-Gear GmbH is a young, highly flexible team, who are carrying out every element of design, assembly and quality control with the utmost care.

The unique combination of the products, together with the know how and assembling facilities are creating for clients a relationship, unique in the valve actuator industries.



GOST certificated

**Pro-Gear**  
VALVE ACTUATORS

Kopenhagener Straße 21  
D-48455 Bad Bentheim - Gildehaus  
Tel +49 (0)5924 255 840 - Fax +49 (0)5924 255 841  
E-mail info@pro-gear.de - www.pro-gear.de

