



DELUXE TYPE MICROWAVE SENSOR

MWS-ST-2-24C [TRANSMITTER]

MWS-SR-2-24C [RECEIVER]

PAT. PEND.

**15 LED Indicator Array for
Easy Visual Adjustment.**



**50m range
with Ø27mm antenna**

WIRE AUTOMATIC DEVICE CO.,LTD.



Due to the sensor's high penetrability, surface contaminants and harsh environments do not affect its operation.

General

The MWS-ST/SR type microwave sensor is a level switch consisting of a transmitter (MWS-ST) and a receiver (MWS-SR) installed face-to-face.

The transmitter emits a continuous, low power microwave beam towards the receiver and an output relay is released when the beam is obstructed.

The sensor has wide application across all areas of industry where highly reliable, non-contact level detection is required. The sensor is generally used for process control by monitoring presence/absence of product, flow/no flow conditions and point level detection in chutes, bins and silos. The sensor may also be used as a proximity switch for detection of vehicles such as dump trucks and rail cars.

Features

• High penetration

Easily penetrates process buildup on antenna, firebrick, refractory etc., thanks to the high penetrability of microwaves.

• Unaffected by adverse environments

The sensor is unaffected by surface contaminants, flames, steam, vapor or airborne particles.

• Simple beam alignment

Easy initial beam alignment at installation, thanks to the wide beam angle.

• Selectable detection mode

Either broken beam (BLOCK) or unbroken beam (UNBLOCK) detection method may be selected.

• Power level & sensitivity indicators

The received power level and the sensitivity-set-point are indicated on the receiver by a bank of 15 LEDs, allowing for easy visual adjustment and maintenance of the sensors

• Lightweight, compact & simple to install

Weights less than 1kg and is housed in a compact aluminum diecast enclosure. Built-in amplifiers mean no interconnection between transmitter and receiver is necessary.

• Small sensing head (Ø27mm)

Approximately 50m range with Ø27mm antenna.

• Enclosure rating IP65 equivalent

Penetrability of microwaves

Harsh environments may result in a buildup of contaminants on the sensing head; however, the sensor is easily able to penetrate such buildup thanks to the high penetrability of microwaves.

When microwaves transmitted through air encounter an object, some will be reflected, some absorbed and the rest will pass through the object. The amount of microwaves passing through the object depends on its composition.

Generally speaking, microwaves cannot penetrate metals and are reflected; water absorbs the most microwaves.

State-of-the-art Heterodyne Detection Method

The MWS-ST/SR level switch is the first of its kind to utilize the heterodyne detection method rather than the, now obsolete, diode detection method.

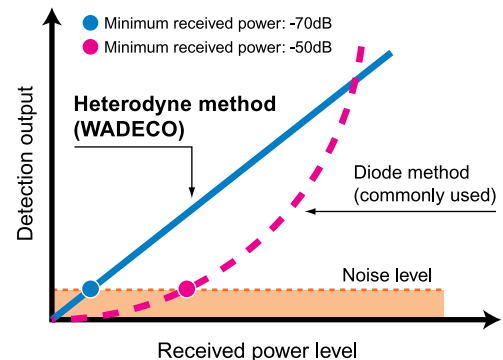

The heterodyne detection method gives detection output that is proportional to the received power level (*linear* function), whereas the diode detection method gives detection output that is proportional to the square of the received power level (*quadratic* function).

Therefore the heterodyne method allows detection with a minimum received power that is lower than that of the minimum level required by the diode detection method. This greatly increases the operating range/penetrability without any increase in the power of the transmitted microwave radiation.

Wiring

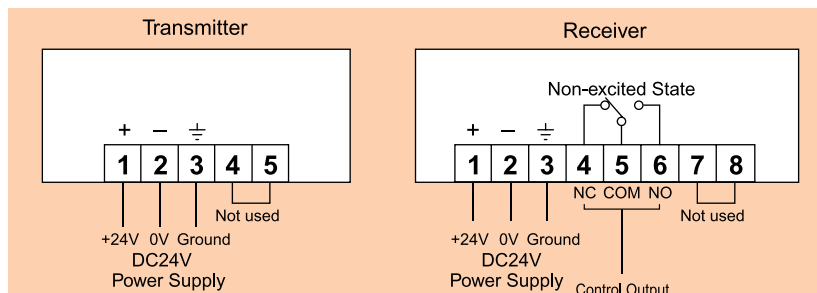

Selection of detection mode and relay configuration

Detection mode	Beam broken BLOCK		Beam unbroken UNBLOCK		
	Terminal number	4 & 5	5 & 6	4 & 5	5 & 6
Unpowered state	Closed	Open	Closed	Open	Open
Powered state	Non-detecting state	Open	Closed	Open	Closed
	Detecting state	Closed	Open	Closed	Open

Function of Switches, Indicators and Rheostats

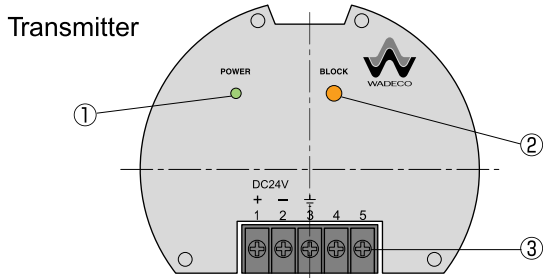

	Part Name	Description
①	Power indicator	Green when power is on
②	Block button	Blocks transmission
③	Terminals	

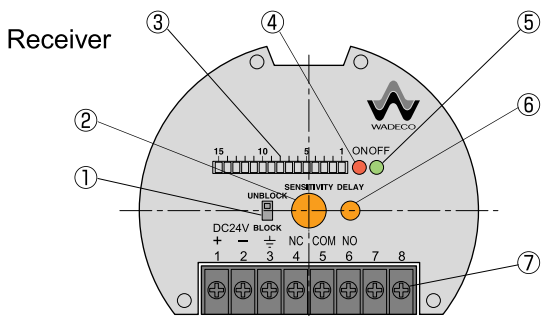

	Part Name	Description
①	Mode selection switch	BLOCK: Outputs on broken beam UNBLOCK: Outputs on unbroken beam
②	Sensitivity rheostat	For sensitivity adjustment
③	15 LED indicator array	Received power level: indicated by one of 15 LEDs Sensitivity set-point: indicated by one of 15 LEDs
④	Output indicator	ON (red): Illuminates on output
⑤	Output indicator	OFF (green): Illuminates on no output
⑥	On delay rheostat	0.1~10 sec.
⑦	Terminals	

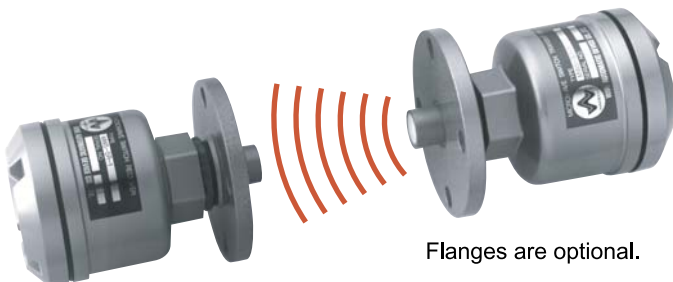

Sensitivity Adjustment

Before adjusting the sensitivity:

- Ensure that there is a clear line of sight between the transmitter and receiver.

Transmitter MWS-ST-2-24C

- Apply power to the unit. The green POWER indicator will illuminate.

Receiver MWS-SR-2-24C

- Apply power to the unit. Either the red ON or the green OFF indicator will illuminate.
- Set the mode selection switch to BLOCK. Turn sensitivity rheostat fully counter clockwise (minimum).
- Turn the delay time rheostat fully counter clockwise (minimum).
- The red output indicator ON will illuminate.
- The sensitivity is adjusted visually using the 15 LED indicator array. The received power level and sensitivity-set-point are indicated on the receiver by a bank of 15 LEDs. Turn the sensitivity rheostat clockwise until the sensitivity-set-point is located halfway between the received power level in the BEAM UNOBSTRUCTED and the BEAM OBSTRUCTED states.

BEAM UNOBSTRUCTED

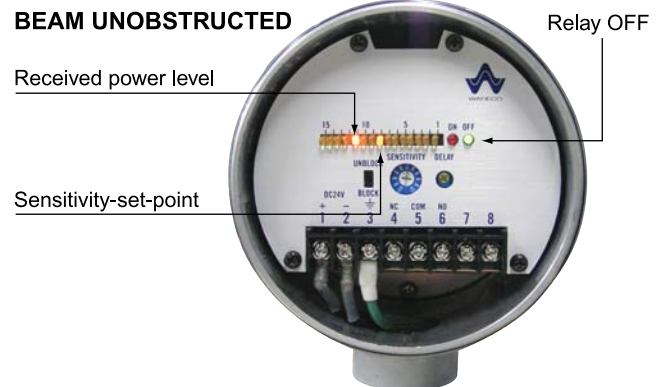

BEAM OBSTRUCTED

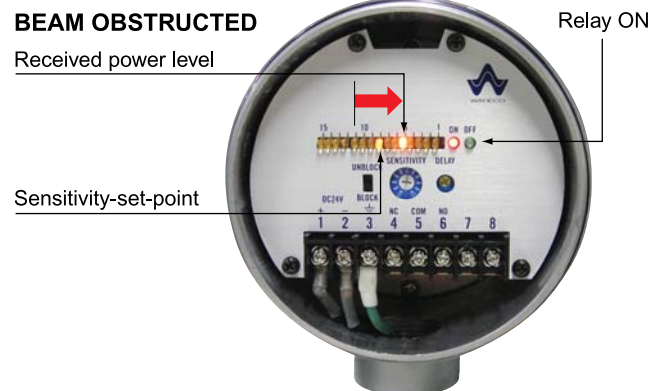

- For an application where material is introduced from above, a suitable delay time must be provided to avoid instantaneous detection of falling material.
- When adjusting the delay time, use the BLOCK button on the transmitter to simulate the beam being blocked.
- To use UNBLOCK output mode, switch the mode selection switch to UNBLOCK.

Specifications

	Transmitter	Receiver
Type	MWS-ST-2-24C	MWS-SR-2-24C
Power supply	DC24V ±10%	
Power consumption	1W, 42mA	2W, 83mA
*Operating distance	40m or less	
Frequency and transmission power	Approx. 24GHz, less than 100mW E.I.R.P.	
CE indication	Complies with all EEC directives for use in heavy industrial environment (R&TTE to EN300440-1/2, EMC to EN301489-1/3 & EN61000-6-2, LVD to EN60950-1)	
Received power level indication	Indicated by 1 of 15 LEDs	
Sensitivity-set-point indication	Indicated by 1 of 15 LEDs	
Radiation angle	Approx. ±20° (angle in half of receiving value)	
Output contact	1C (SPDT) relay contact DC30V, 2A	
Response time	10msec.	
On delay	0.1 ~ 10sec.	
Delay time from power on to function	Approx. 50msec.	Approx. 5sec.
Operating ambient temperature	-10°C ~ +55°C	
Non-function ambient temperature	-20°C ~ +70°C	
Continuous maximum pressure	0.5MPa	
Enclosure rating	IP65 equivalent	
Enclosure construction	Diecast aluminum	
Color	Metallic silver grey	
Weight	1kg	1kg

* The operating distance may vary from sensor to sensor and according to installation.

Installation

Install the transmitter and receiver face to face as shown below.

Both unit's cable entry should face in the same direction, or be 180° opposite each other.

Cable entry in the same direction.

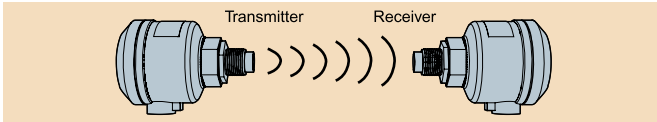

Cable entry 180° opposite each other.

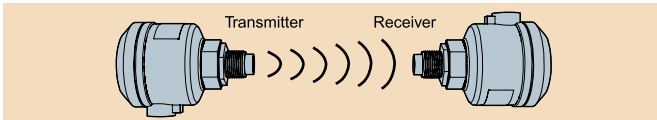

If the units are installed with cable entries at 90° to each other they will not function.

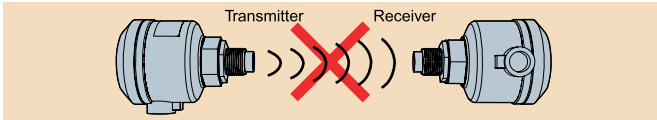

If two transmitter-receiver sets are installed in close proximity, one transmitter-receiver set should be mounted at a 90° angle to the other so that the waves of one unit will not interfere with the other's.

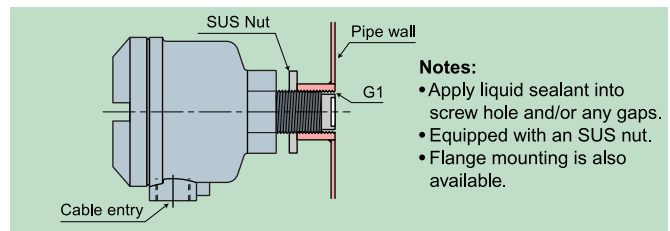
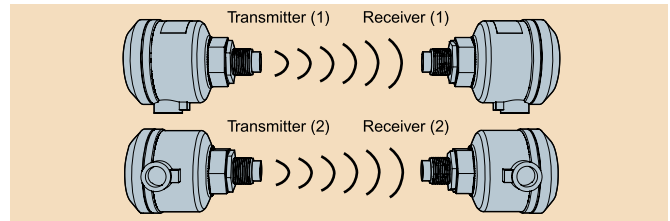

Dimensions

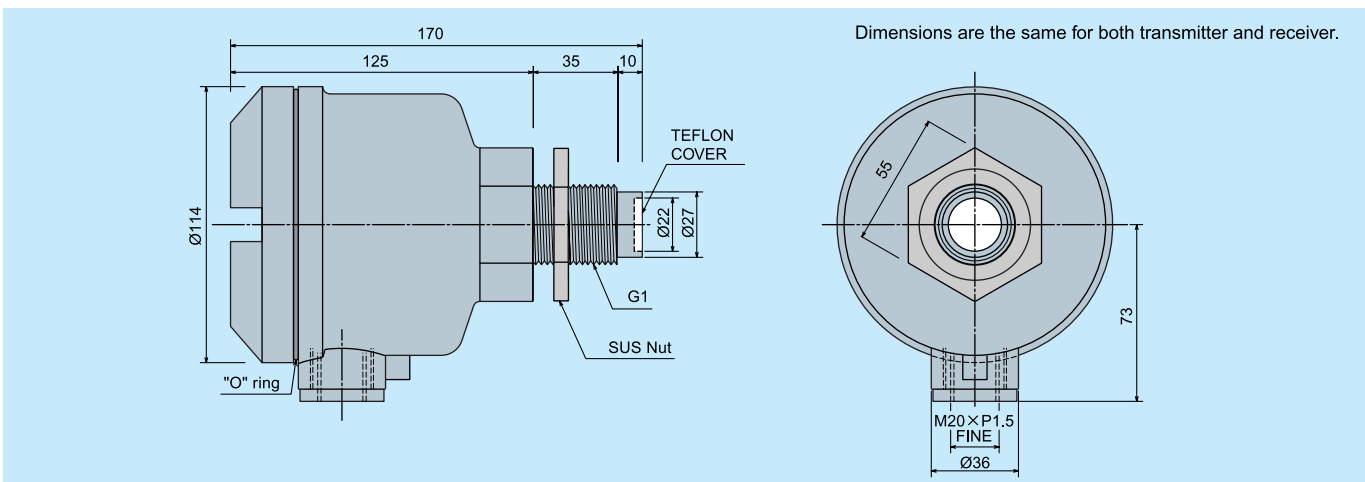

Specifications may be changed without notification.



WIRE AUTOMATIC DEVICE CO., LTD.

HEAD OFFICE 1-9-27, Jokoji, Amagasaki-shi, Hyogo-ken 660-0811, Japan
TEL. +81-6-6482-3838 FAX. +81-6-6481-6321

TOKYO BRANCH 202 Shibuya-homes, 2-1, Udagawa-cho, Shibuya-ku, Tokyo
150-0042, Japan
TEL. +81-3-3770-5519 FAX. +81-3-3770-5520

URL : <http://www.wadeco.co.jp>

SEMRAD PTY LTD.,
11D, 35/37 Railway Parade, Engadine,
NSW 2233 Australia.
Tel. 61-2-9520-0222 Fax 61-2-9520-1333
Email: sales@semrad.com.au
Web: www.semrad.com.au