

LINEAR POTENTIOMETER

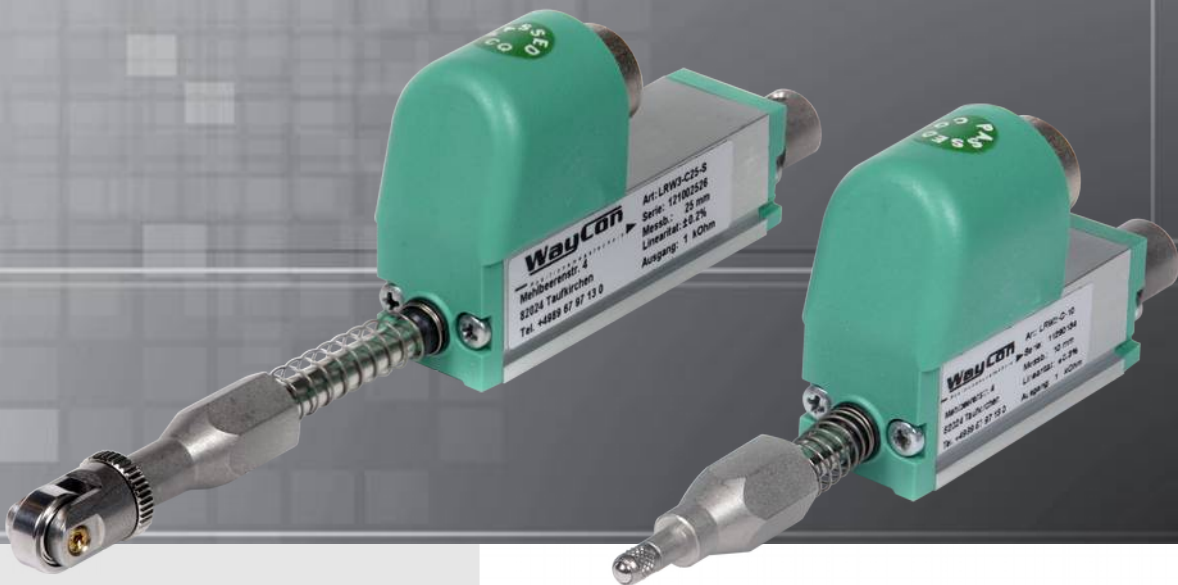

LRW2 / LRW3 Series

Key-Features:

- LRW2 with ball tip, available measurement ranges from 10 to 150 mm
- LRW3 with roller tip, available measurement ranges from 10 to 50 mm
- Double rod support and return spring
- Displacement speed ≤ 10 m/s
- Linearity up to ± 0.10 %
- Working temperature $-30...+100$ °C
- Life cycle $> 25 \times 10^6$ m, or $> 100 \times 10^6$ operations, whichever is less
- Simple apparatus according to the EN 60079-11 standard

Content:

Technical Data2
Technical Drawing2
Electrical Connection & Accessories3
Order Code4

TECHNICAL DATA

Measurement range LRW2 (ball tip)	[mm]	10 / 25 / 50 / 75 / 100 / 150
Measurement range LRW3 (roller tip)	[mm]	10 / 25 / 50
Protection class		IP40
Displacement speed	[m/s]	≤10
Displacement force	[N]	≤4 N
Linearity		see table
Resolution		Resolution depends on the signal quality of the reference voltage respectively supply voltage.
Tolerance on resistance	[%]	±20
Recommended cursor current	[µA]	<0.1
Maximum cursor current	[mA]	10
Temperature coefficient of resistance	[ppm/°C]	±200
Temperature coefficient of the output voltage	[ppm/°C]	<1.5
Electrical Isolation		>100 MOhm at 500 V~, 1 bar, 2 s
Dielectric strength		<100 µA at 500 V~, 50 Hz, 1 bar, 2 s
Working temperature	[°C]	-30...+100
Storage temperature	[°C]	-50...+120
Life cycle		>25 x 10 ⁶ m or >100 x 10 ⁶ operations (whichever is less)
Rod material		stainless steel AISI 303
Case material		anodised aluminium Nylon 66 G25
Mounting		4 adjustable angle brackets (included in delivery), option: PKIT006 2 large brackets

DIMENSIONS AND ELECTRICAL DATA

Useful electrical stroke (B) +1/-0	[mm]	10	25	50	75	100	150
Theoretical electrical stroke (C) ±1	[mm]	B + 1					
Resistance	[kOhm]	1	1	5	5	5	5
Linearity	[%]	±0.3	±0.2	±0.1	±0.1	±0.1	±0.05
Dissipation at 40°C (0 W at 120 °C)	[W]	0.2	0.6	1.2	1.8	2.4	3.6
Maximum applicable voltage	[V]	14	25	60	60	60	60
Mechanical stroke (D)	[mm]	B + 5					
Case length (A)	[mm]	B + 38					
Tip length (E) LRW2	[mm]	32	32	40	40	40	40
Tip length (E) LRW3	[mm]	43	43	51	-	-	-
Total length LRW2	[mm]	108	138	196	251	307	426
Total length LRW3	[mm]	119	149	207	-	-	-

TECHNICAL DRAWING

LRW2-C: with ball tip and connector output

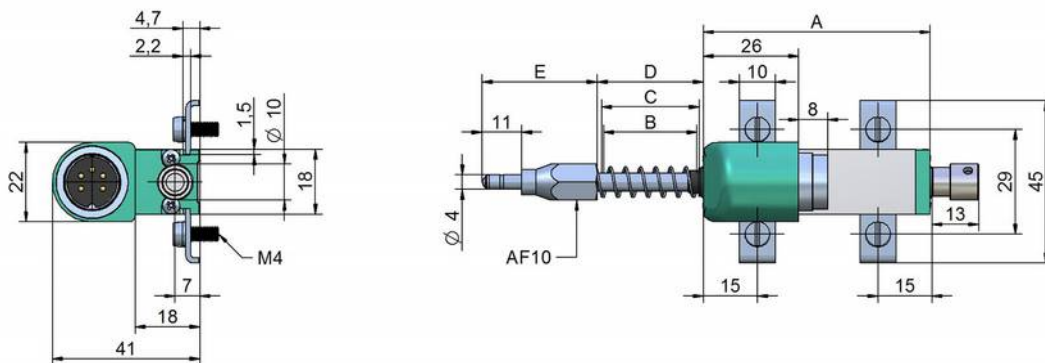

TECHNICAL DRAWING

LRW2-F: with ball tip and cable output

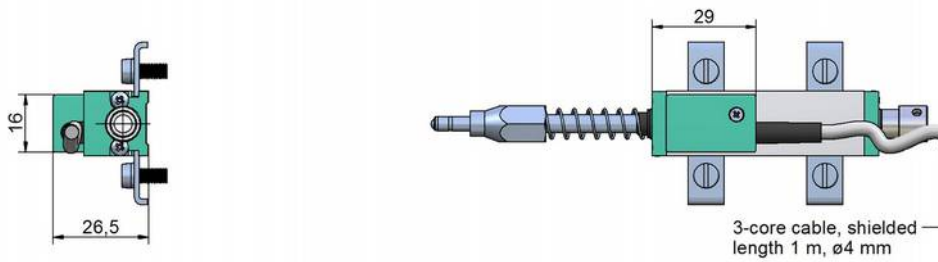

LRW3-C: with roller tip and connector output

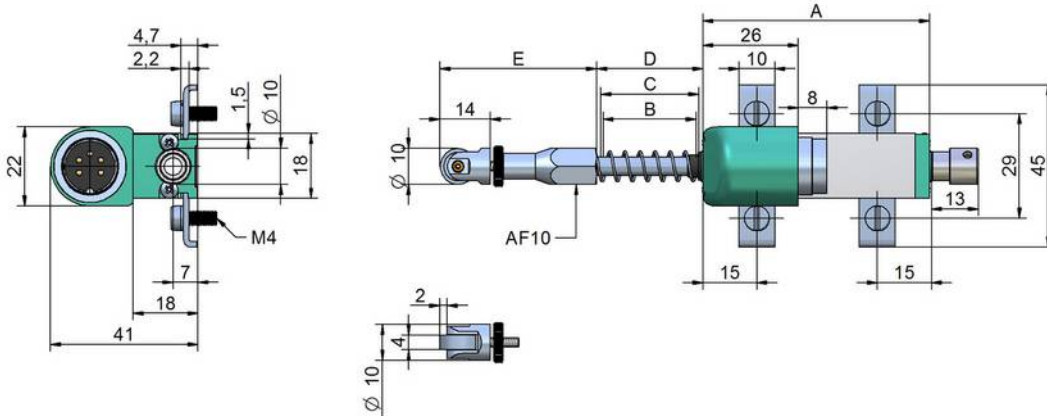

LRW3-F: with roller tip and connector output

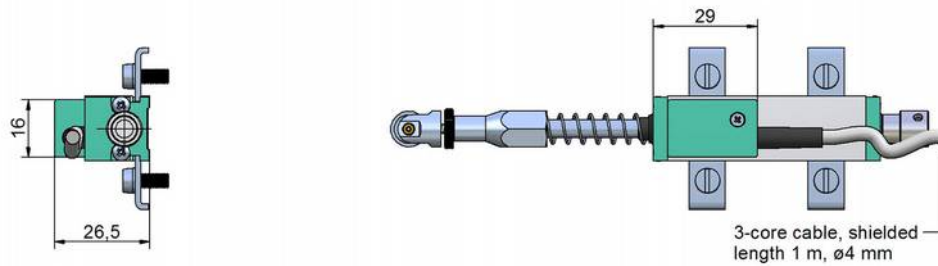

ELECTRICAL CONNECTION AND ACCESSORIES

Electrical connection

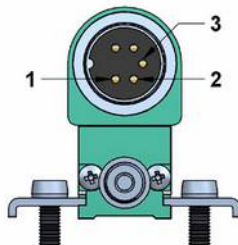
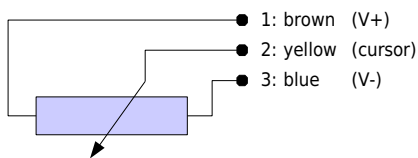

Installation instructions

- Please pay attention that the sensor is not used as a variable resistor.
- Please be careful while calibrating the sensor to set the stroke so that the output signal does not drop below 1 % or exceed 99 % of the supply voltage.

CON011: Mating connector for LRW2-C, LRW3-C

for self assembly
IP40, 5 pole, cable diameter 4...6 mm



Signal conditioner PMX-24

- Converts potentiometer signals into analog output signals
- Input: potentiometer 1...20 kΩ
- Configurable output
- DIN-rail-mounting with face-side connector
- For further information see separate data sheet



TECHNICAL DRAWING

LRW2-F: with ball tip and cable output

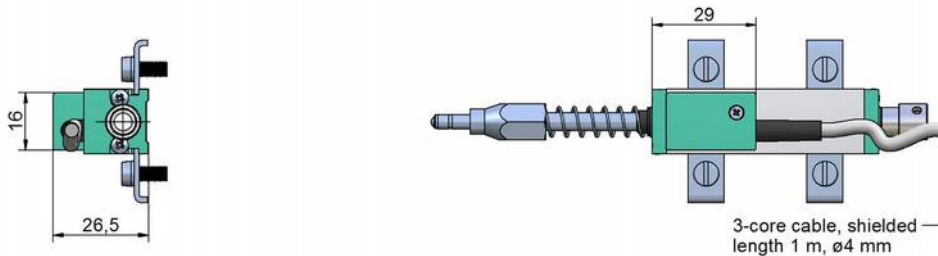

LRW3-C: with roller tip and connector output

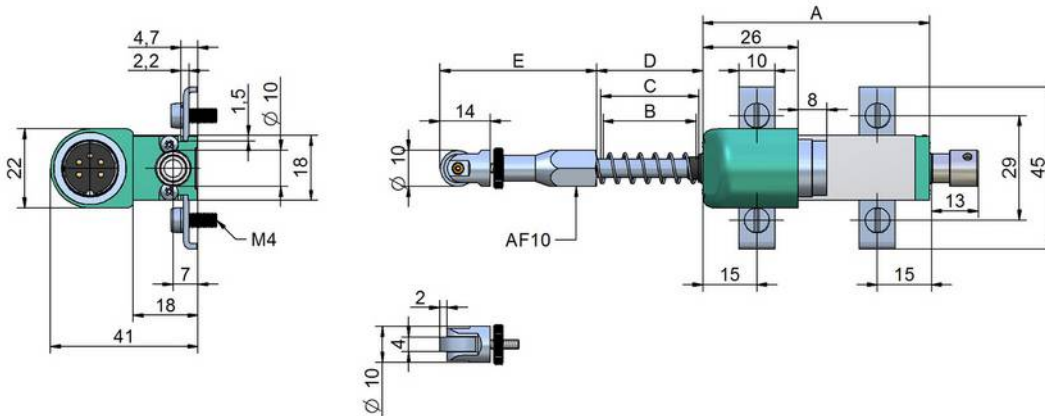

LRW3-F: with roller tip and connector output

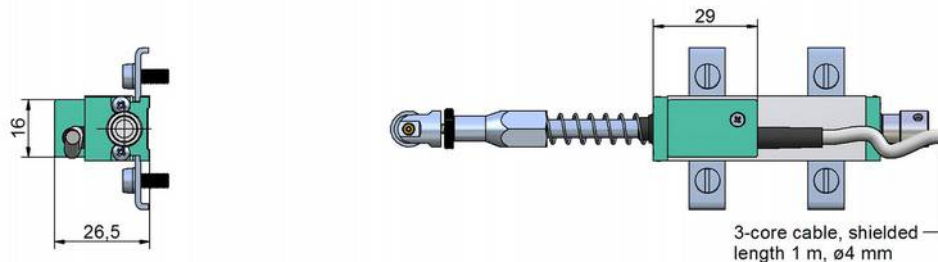

ELECTRICAL CONNECTION AND ACCESSORIES

Electrical connection

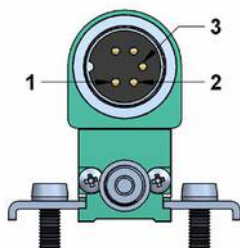
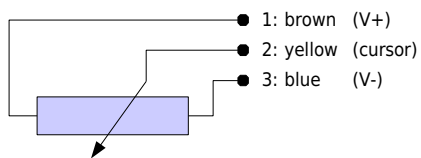

Installation instructions

- Please pay attention that the sensor is not used as a variable resistor.
- Please be careful while calibrating the sensor to set the stroke so that the output signal does not drop below 1 % or exceed 99 % of the supply voltage.

CON011: Mating connector for LRW2-C, LRW3-C

for self assembly
IP40, 5 pole, cable diameter 4...6 mm



Signal conditioner PMX-24

- Converts potentiometer signals into analog output signals
- Input: potentiometer 1...20 kΩ
- Configurable output
- DIN-rail-mounting with face-side connector
- For further information see separate data sheet



ORDER CODE

LRW with cable output

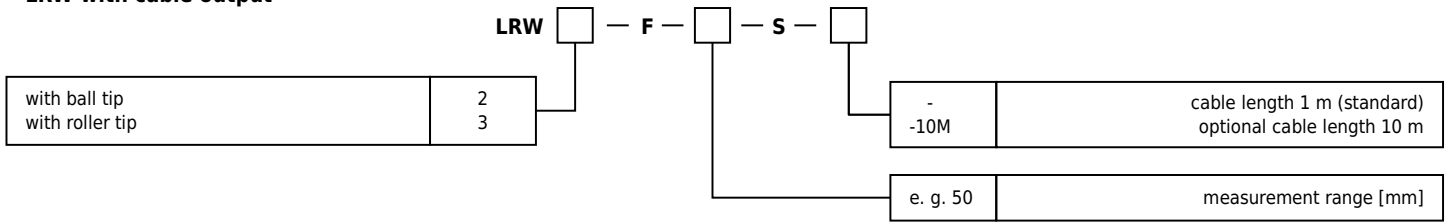

LRW with connector output

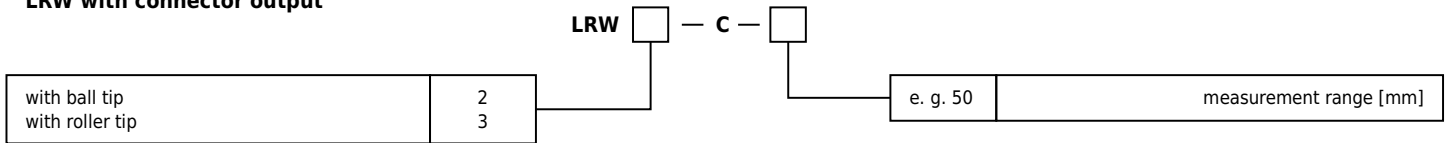

OPTIONS AND ACCESSORIES

Options

-10M cable length 10 m

Accessories

CON011 mating connector, 5-pole, IP40
 PKIT005 mounting kit (is included in delivery)
 PKIT006 mounting kit consisting of 2 large brackets, screws
 PTAS000 ball tip (LRW2: included in delivery)
 PTAS001 roller tip (LRW3: included in delivery)

Signal Conditioner

PMX-24 different analog output signals in one device
 For further information please contact WayCon or [download](#) the data sheet.