

### Product Description

Qorvo's TGA2963-CP is a broadband high power MMIC amplifier fabricated on Qorvo's production 0.15um GaN on SiC process (QGaN15). The TGA2963-CP operates from 6 – 18 GHz and typically provides 20 W saturated output power with power-added efficiency of 20% and large-signal gain of 18 dB. This combination of wideband performance provides the flexibility designers are looking for to improve system performance while reducing size and cost.

The TGA2963-CP is offered in a 10-lead 15 x 15 mm bolt-down package. Assembled with a pure-copper base, coupled with its high efficiency, the TGA2963-CP minimizes the strain on the system-level cooling requirements, further reducing system operating costs. The broadband performance makes it ideally suited to support test instrumentation and electronic warfare, as well as, supporting multiple radar and communication bands.

Both RF ports have integrated DC blocking capacitors and are fully matched to 50 Ohms.

Lead free and RoHS compliant.

Evaluation Boards are available upon request.

### Functional Block Diagram

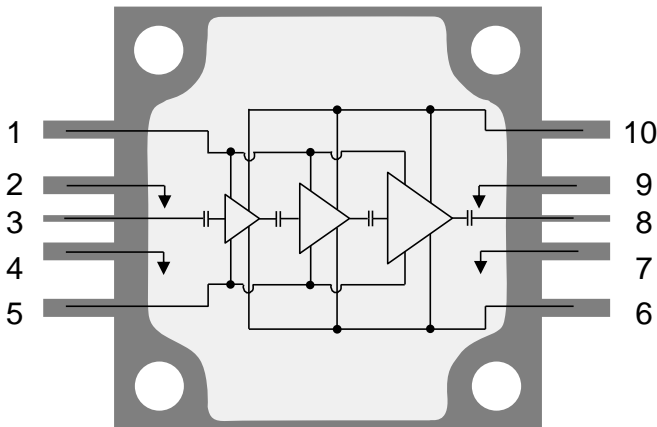

### Product Features

- Frequency Range: 6 – 18 GHz
- P<sub>OUT</sub>: 43 dBm @ P<sub>IN</sub> = 25 dBm
- PAE: 20 % @ P<sub>IN</sub> = 25 dBm
- Large Signal Gain: 18 dB @ P<sub>IN</sub> = 25dBm
- Small Signal Gain: 26 dB
- Bias: V<sub>D</sub> = +20 V, I<sub>DQ</sub> = 2500 mA, V<sub>G</sub> = -2.3 V Typical
- Process Technology: QGaN15
- Package Dimensions: 15.2 x 15.2 x 3.5 mm
- Package base is pure Cu offering superior thermal management

*Performance is typical across frequency. Please reference electrical specification table and data plots for more details.*

### Applications

- Test Instrumentation
- Electronic Warfare (EW)
- Radar
- Communications

### Ordering Information

Part No.	ECCN	Description
TGA2963-CP	3A001.b.2.c	6 – 18 GHz 20 W GaN Power Amplifier

### Electrical Specifications

Test conditions unless otherwise noted: 25 °C,  $V_D = +20\text{ V}$ ,  $I_{DQ} = 2500\text{ mA}$ ,  $V_G = -2.3\text{ V}$  Typical, CW.

Parameter	Min	Typ	Max	Units
Operational Frequency Range	6	–	18	GHz
Output Power @ $P_{IN} = 25\text{ dBm}$	Frequency = 6 GHz	42.8	–	dBm
	Frequency = 12 GHz	45	–	
	Frequency = 18 GHz	43	–	
Power Added Efficiency @ $P_{IN} = 25\text{ dBm}$	Frequency = 6 GHz	21	–	%
	Frequency = 12 GHz	24	–	
	Frequency = 18 GHz	18	–	
Small Signal Gain	Frequency = 6 GHz	28	–	dB
	Frequency = 12 GHz	34	–	
	Frequency = 18 GHz	24	–	
Input Return Loss	Frequency = 6 GHz	16	–	dB
	Frequency = 12 GHz	12	–	
	Frequency = 18 GHz	9	–	
Output Return Loss	Frequency = 6 GHz	10	–	dB
	Frequency = 12 GHz	7.7	–	
	Frequency = 18 GHz	6.7	–	
Small Signal Gain Temperature Coefficient	–	-0.08	–	dB/°C
Output Power Temperature Coefficient	–	-0.015	–	dBm/°C

### Recommended Operating Conditions

Parameter	Value / Range
Drain Voltage ( $V_D$ )	+20 V
Drain Current ( $I_{DQ}$ )	2500 mA
Gate Voltage ( $V_G$ )	-2.3 V (Typ.)
Temperature ( $T_{BASE}$ )	-40 to 85 °C

Electrical specifications are measured at specified test conditions. Specifications are not guaranteed over all recommended operating conditions.

### Performance Plots – Large Signal (CW)

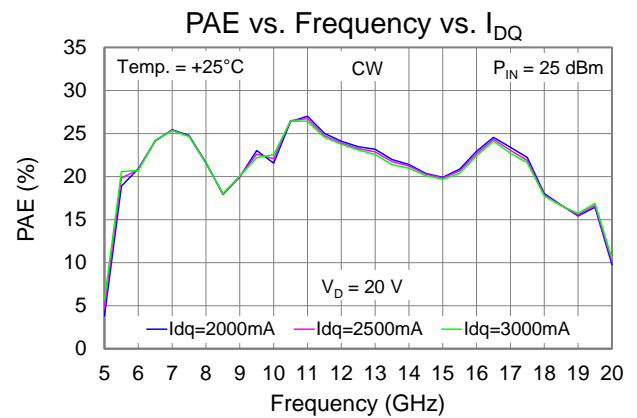
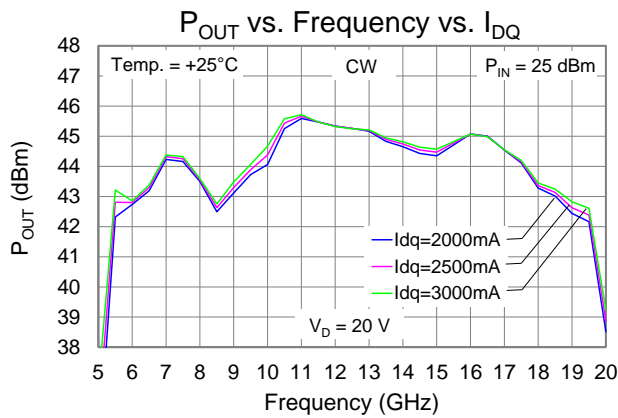
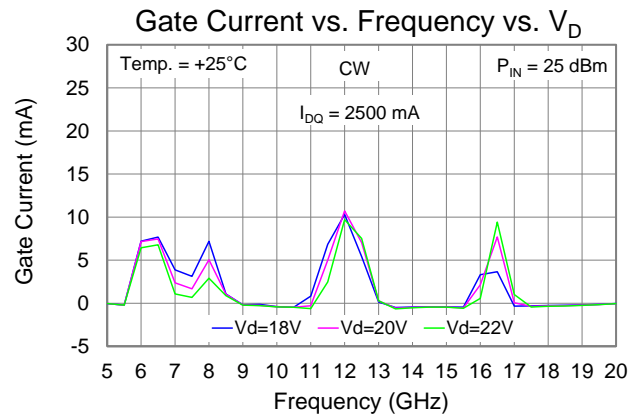
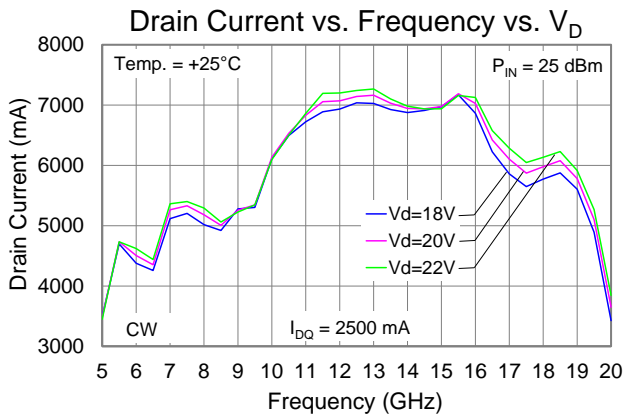
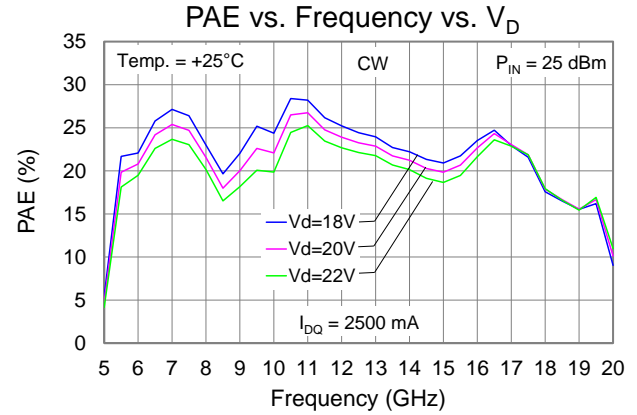
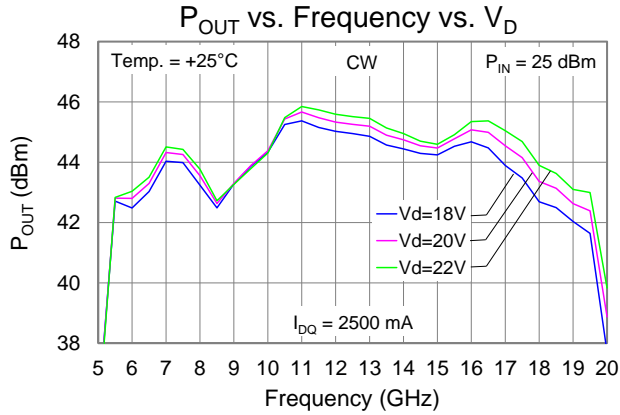

### Performance Plots – Large Signal (CW)

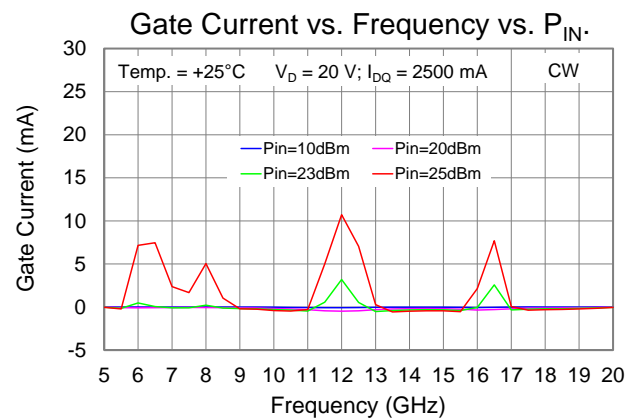
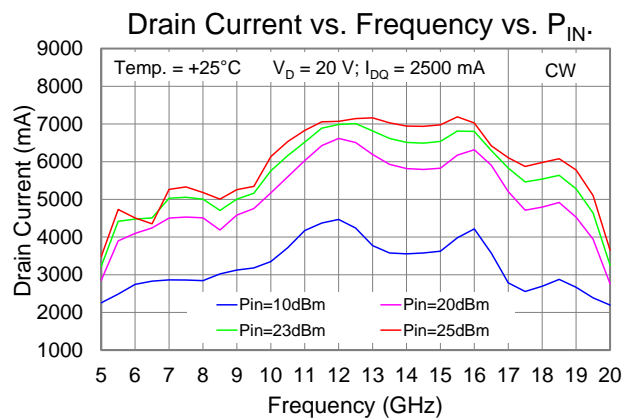
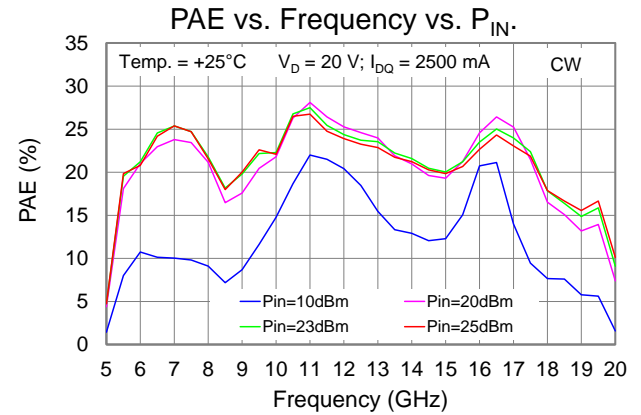
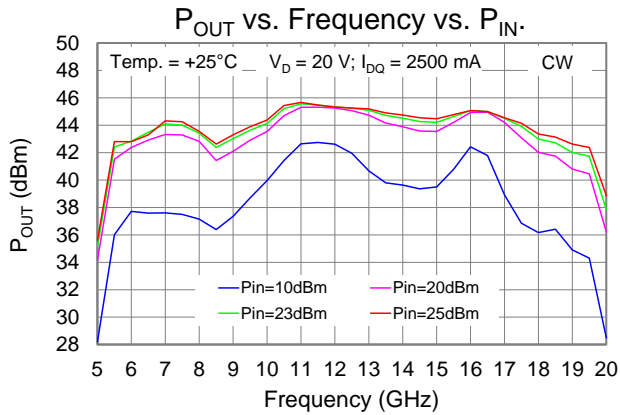
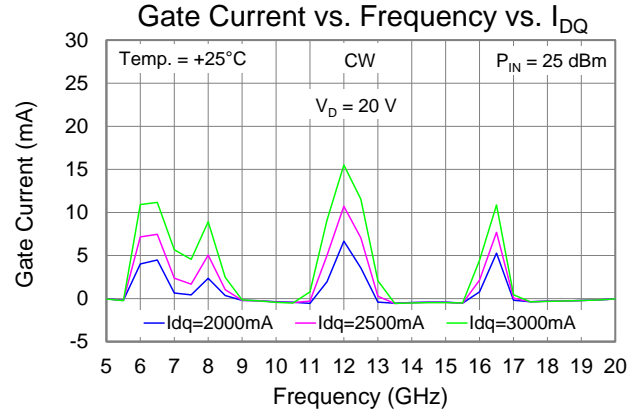
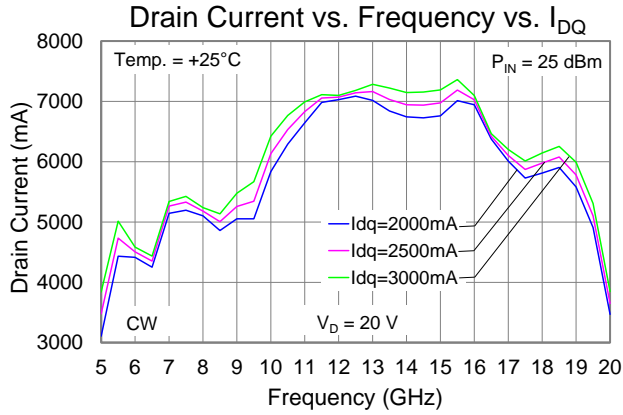

### Performance Plots – Large Signal (CW)

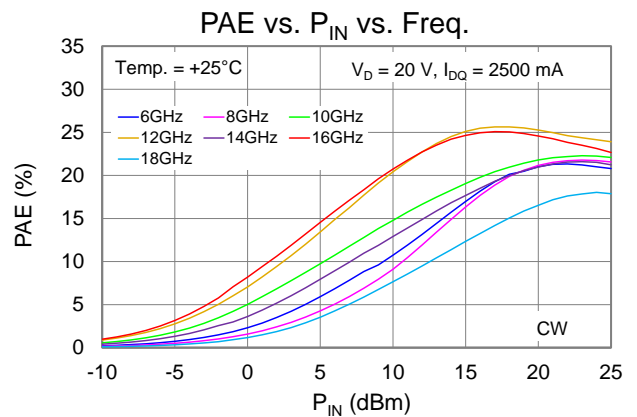
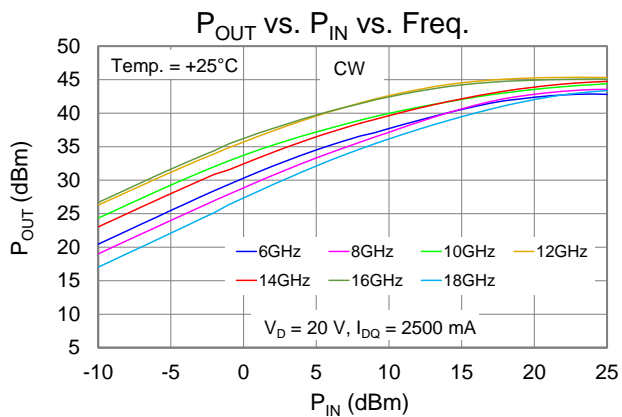
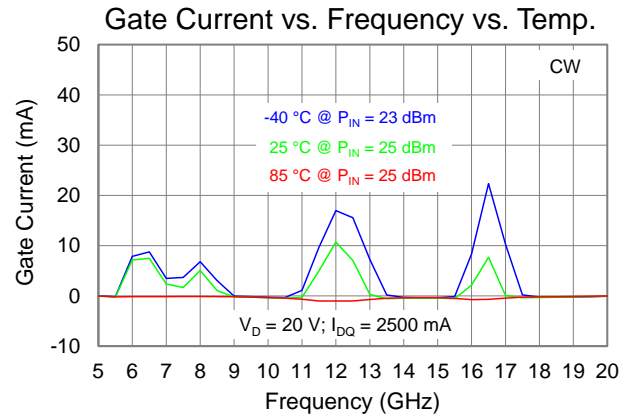
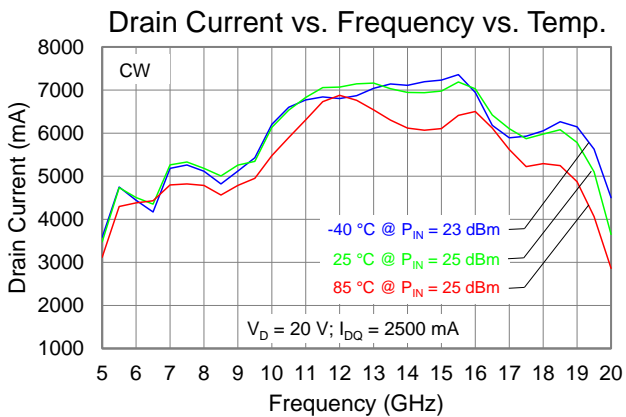
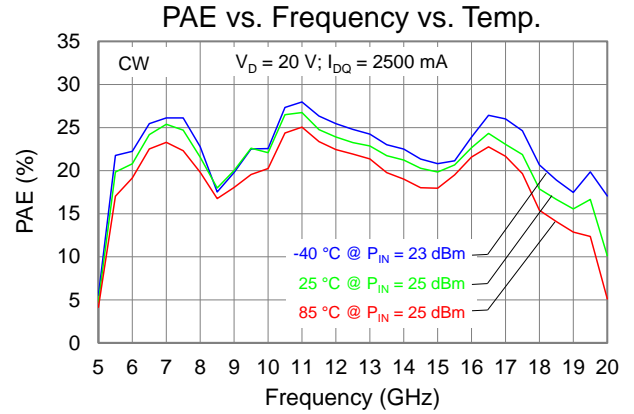
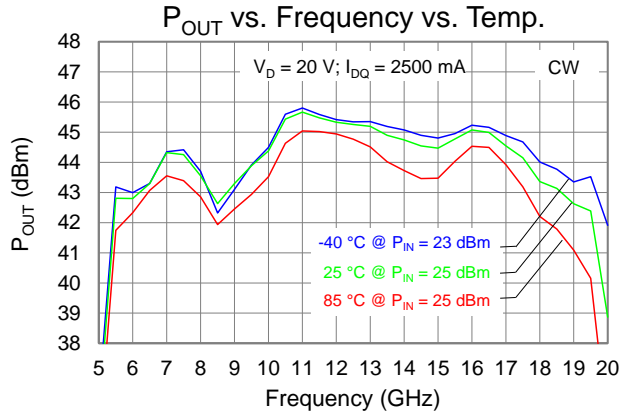

### Performance Plots – Large Signal (CW)

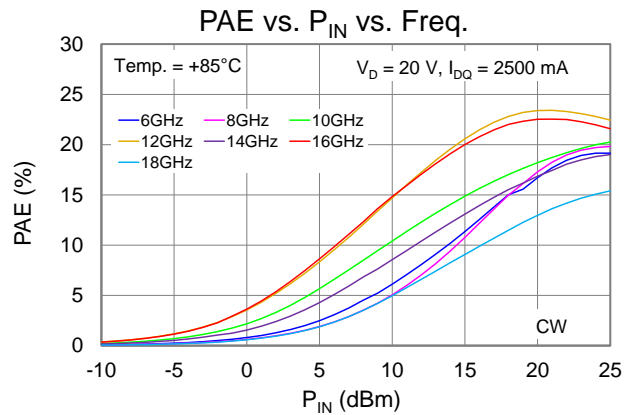
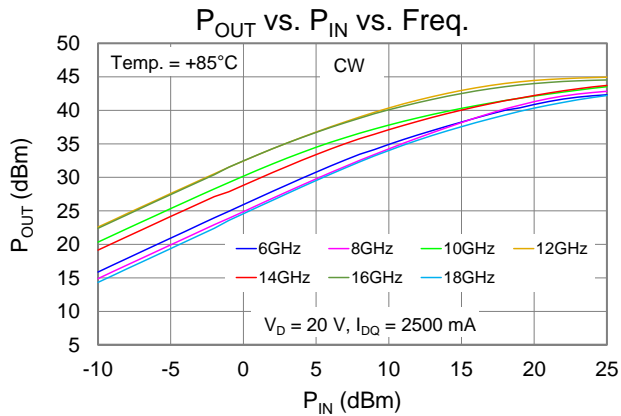
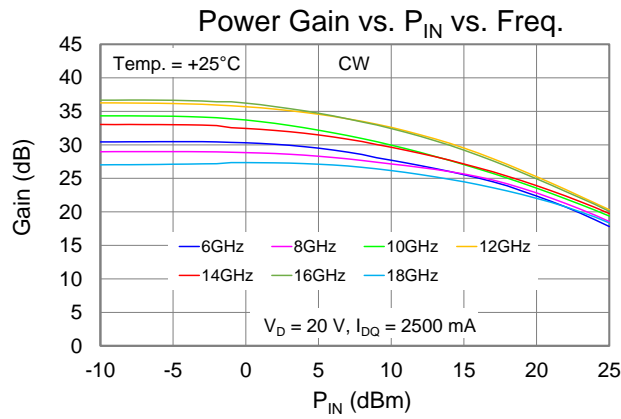
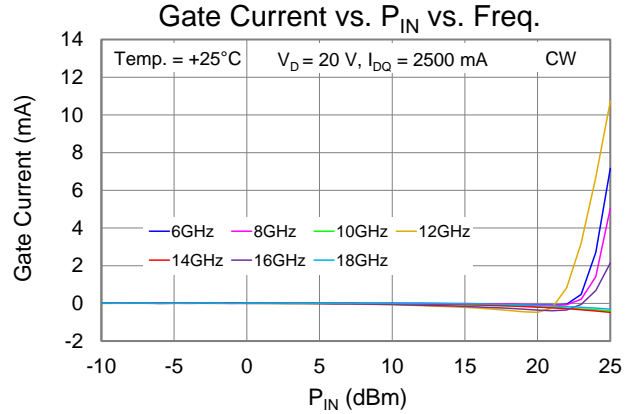
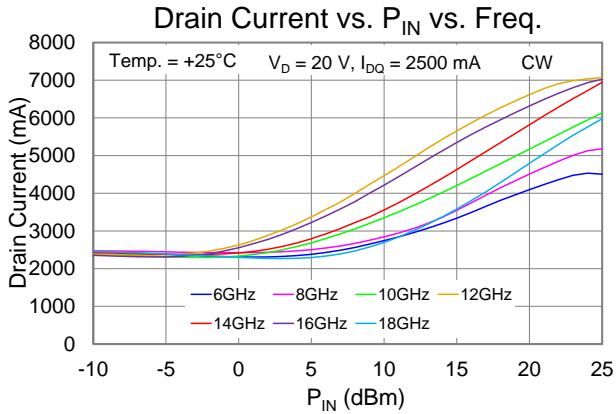

### Performance Plots – Large Signal (Pulsed)

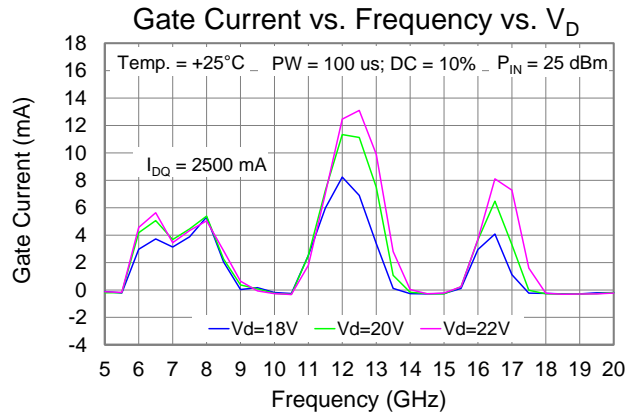
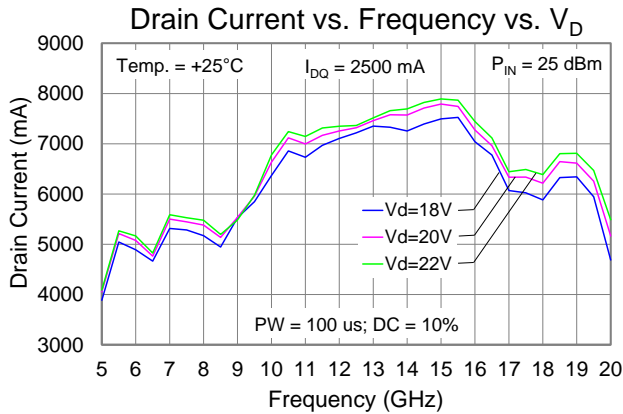
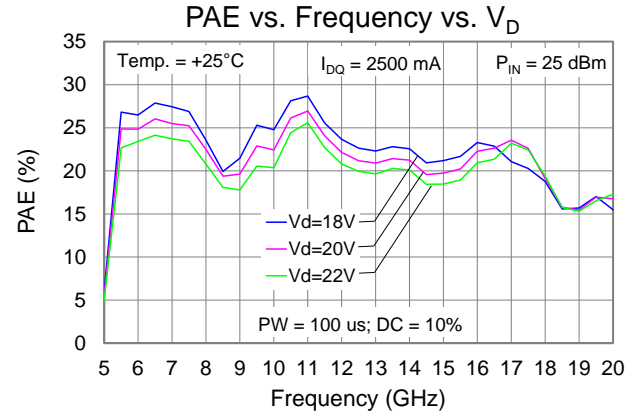
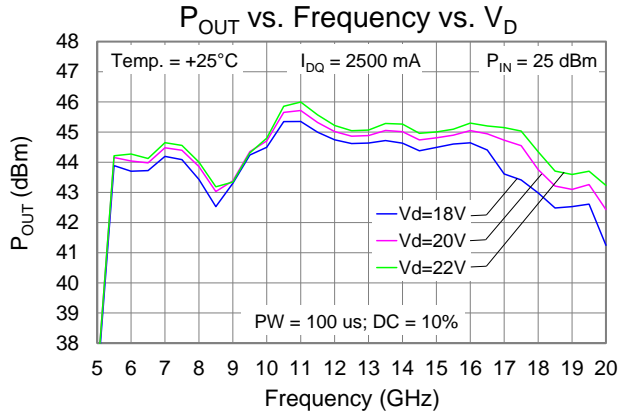

### Performance Plots – Linearity

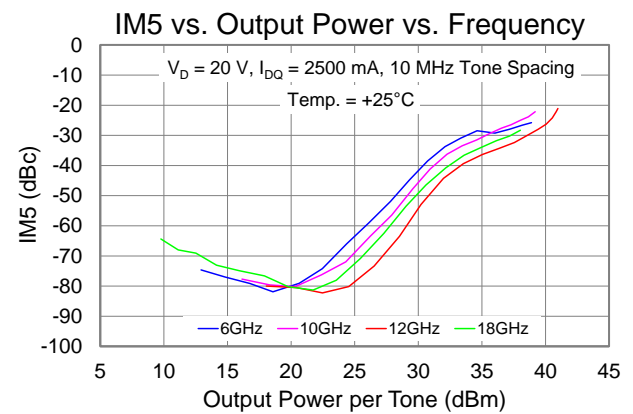
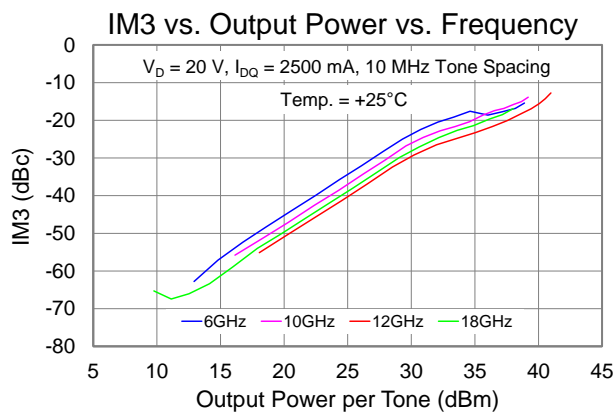
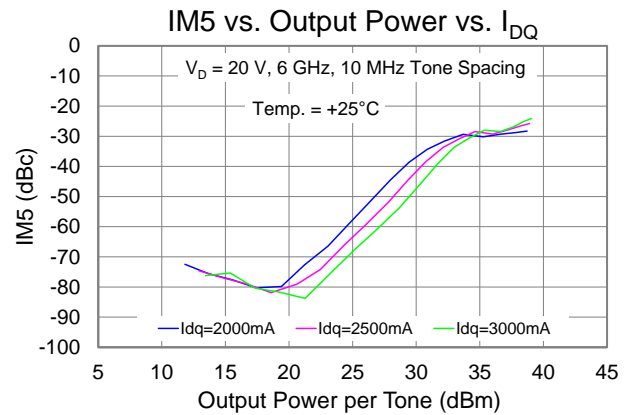
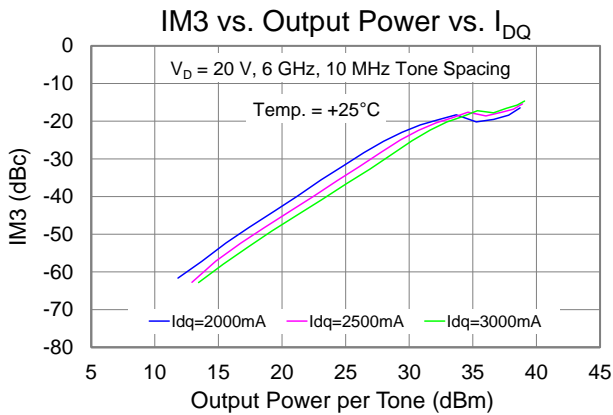
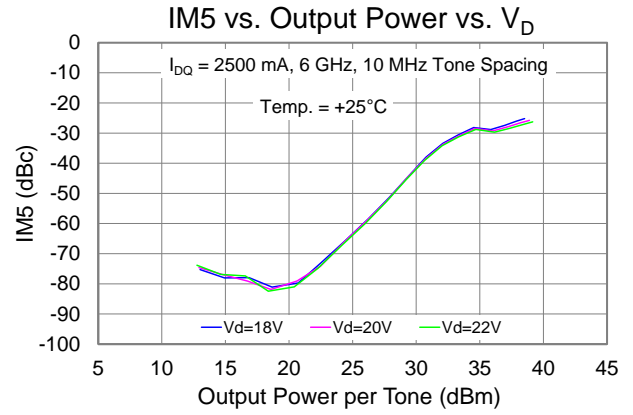
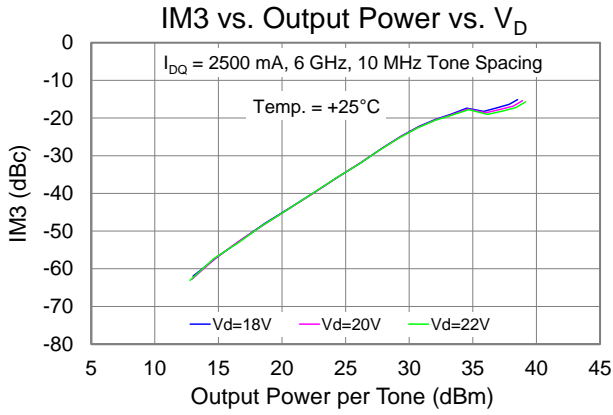



### Performance Plots – Linearity

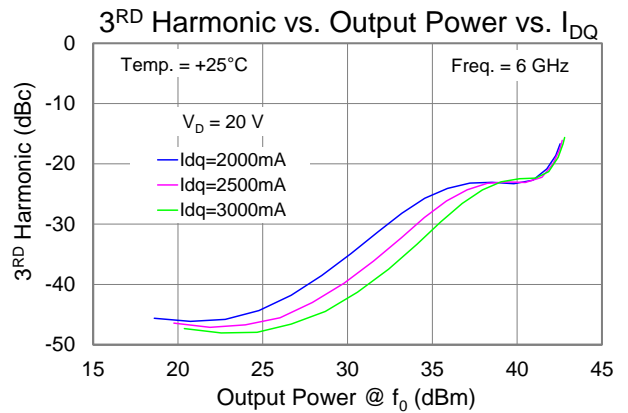
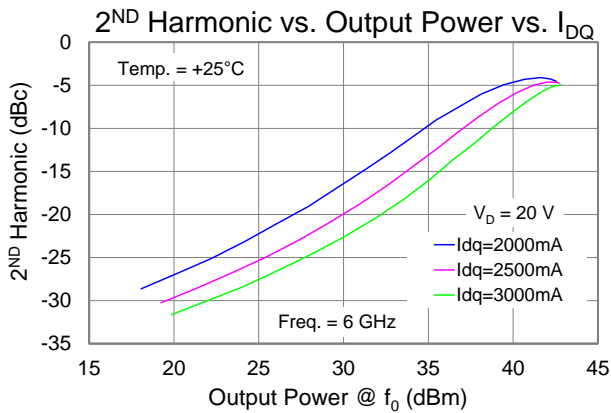
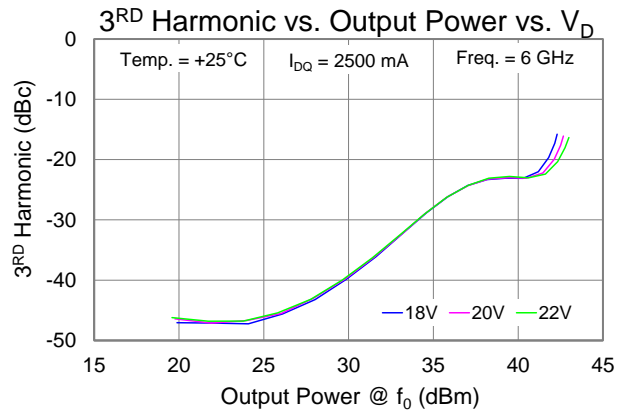
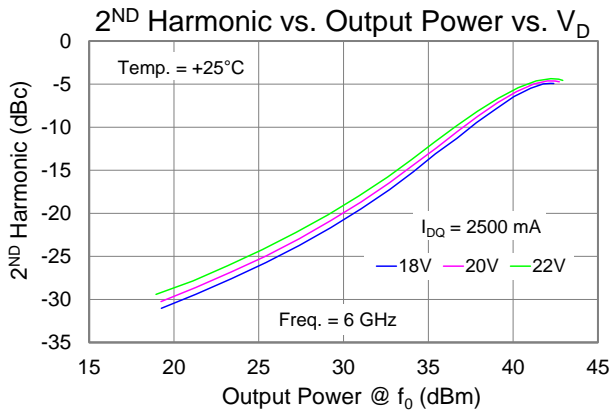
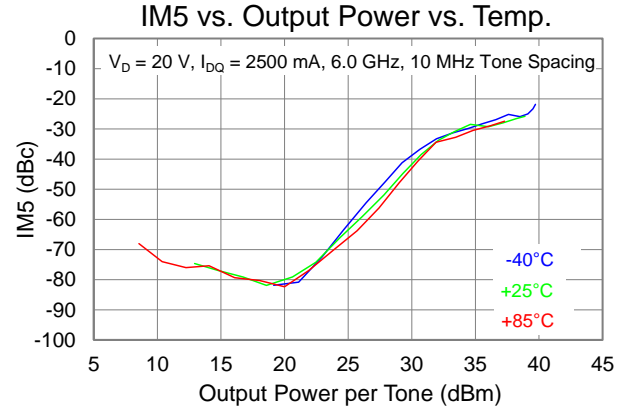
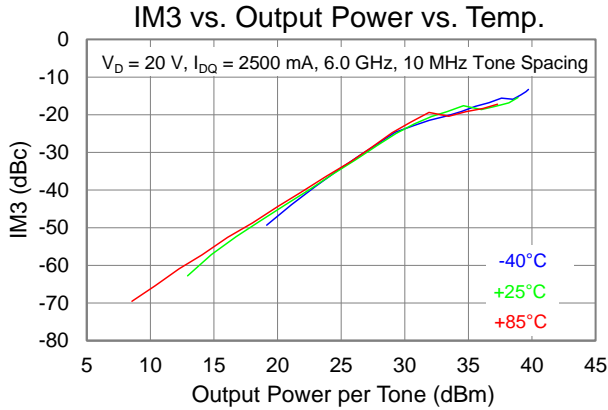

### Performance Plots – Linearity

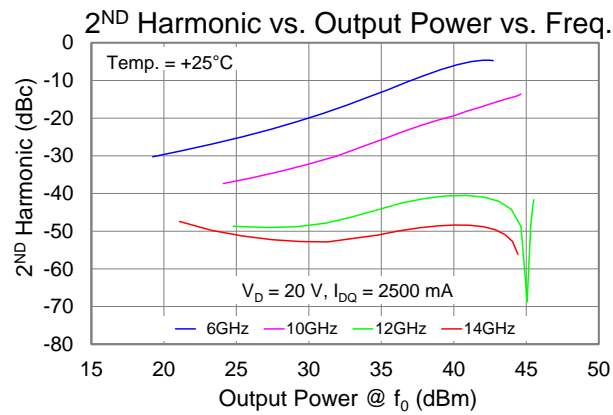
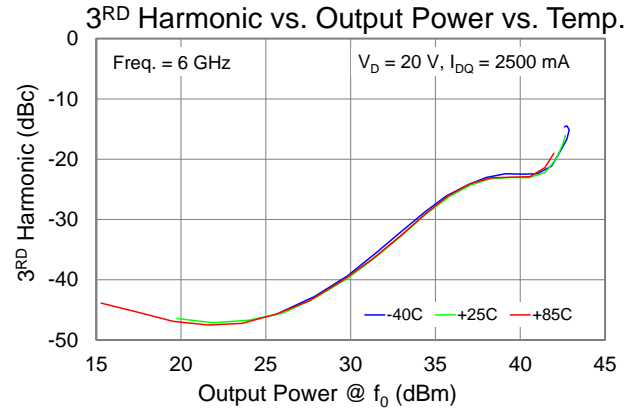
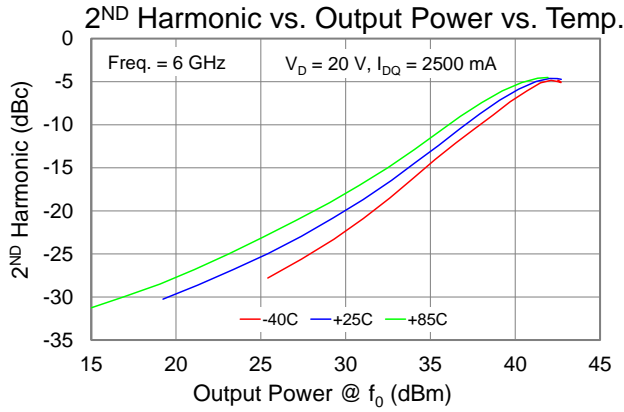

### Performance Plots – Small Signal

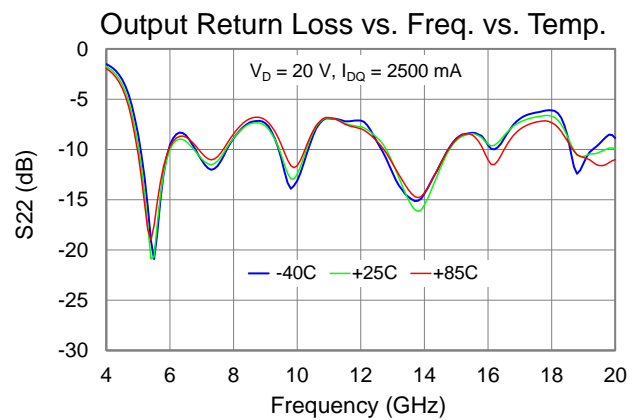
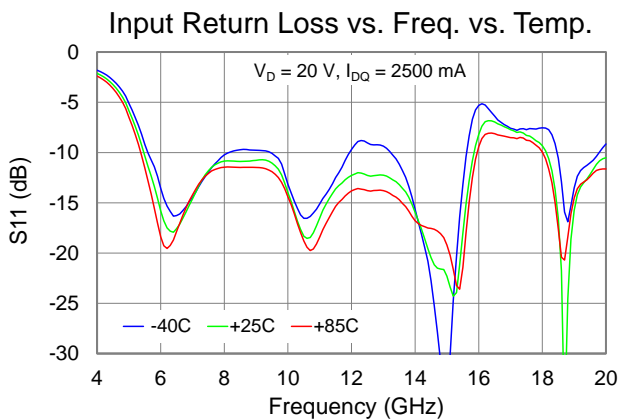
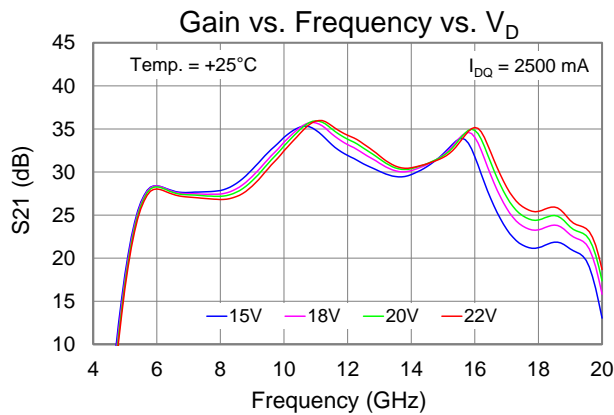
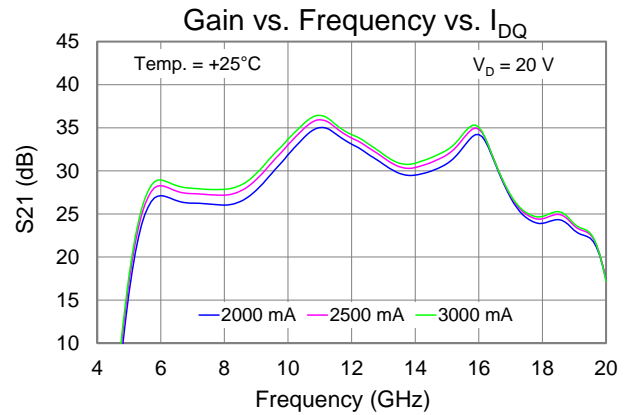
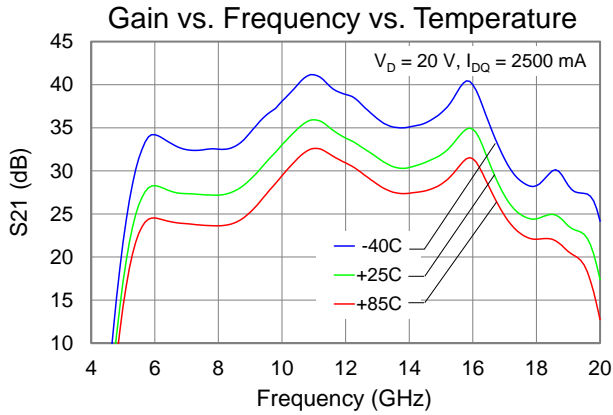

### Thermal and Reliability Information

Parameter	Test Conditions	Value	Units
Thermal Resistance ( $\theta_{JC}$ ) <sup>(1)</sup>	$T_{BASE} = 85^\circ\text{C}$ , $V_D = +20\text{ V (CW)}$ At $I_{DQ} = 2500\text{ mA}$ , $P_{DISS} = 50\text{ W}$	1.1	$^\circ\text{C/W}$
Channel Temperature ( $T_{CH}$ ) (Quiescent)		140	$^\circ\text{C}$
Median Lifetime ( $T_M$ )		2.6E+10	Hrs
Thermal Resistance ( $\theta_{JC}$ ) <sup>(1)</sup>	$T_{BASE} = 85^\circ\text{C}$ , $V_D = +20\text{ V (CW)}$ At Freq = 12 GHz, $P_{IN} = 25\text{ dBm}$ : $I_{DQ} = 2500\text{ mA}$ , $I_{D\_Drive} = 6.9\text{ A}$ $P_{OUT} = 45\text{ dBm}$ , $P_{DISS} = 107\text{ W}$	1.32	$^\circ\text{C/W}$
Channel Temperature ( $T_{CH}$ ) (Under RF drive)		226	$^\circ\text{C}$
Median Lifetime ( $T_M$ )		6.9E+6	Hrs
Thermal Resistance ( $\theta_{JC}$ ) <sup>(1)</sup>	$T_{BASE} = 85^\circ\text{C}$ , $V_D = +22\text{ V (CW)}$ At Freq = 12 GHz, $P_{IN} = 25\text{ dBm}$ : $I_{DQ} = 2500\text{ mA}$ , $I_{D\_Drive} = 7\text{ A}$ $P_{OUT} = 45\text{ dBm}$ , $P_{DISS} = 120\text{ W}$	1.36	$^\circ\text{C/W}$
Channel Temperature ( $T_{CH}$ ) (Under RF drive)		250	$^\circ\text{C}$
Median Lifetime ( $T_M$ )		1.1E+6	Hrs

Notes:

1. Thermal resistance measured to back of package.

### Median Lifetime

Test Conditions:  $V_D = +28\text{ V}$ ; Failure Criteria = 10% reduction in  $I_{DQ\_MAX}$

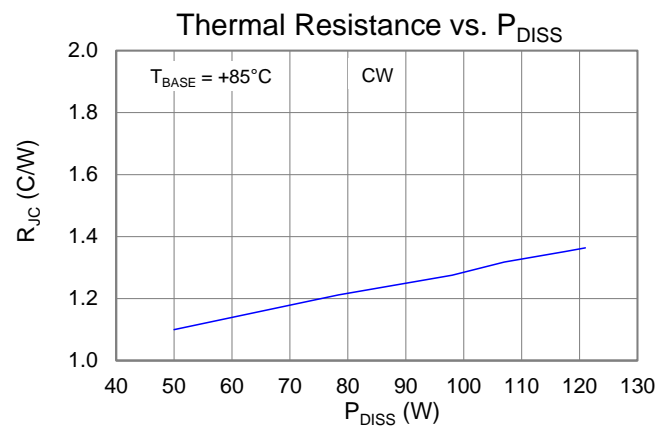
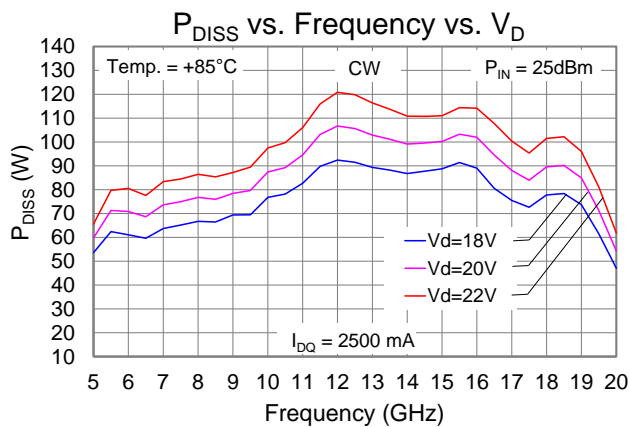
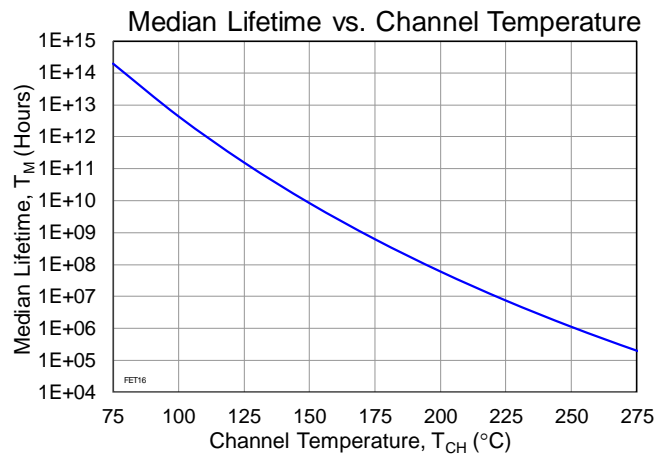

### Applications Information and Pad Layout

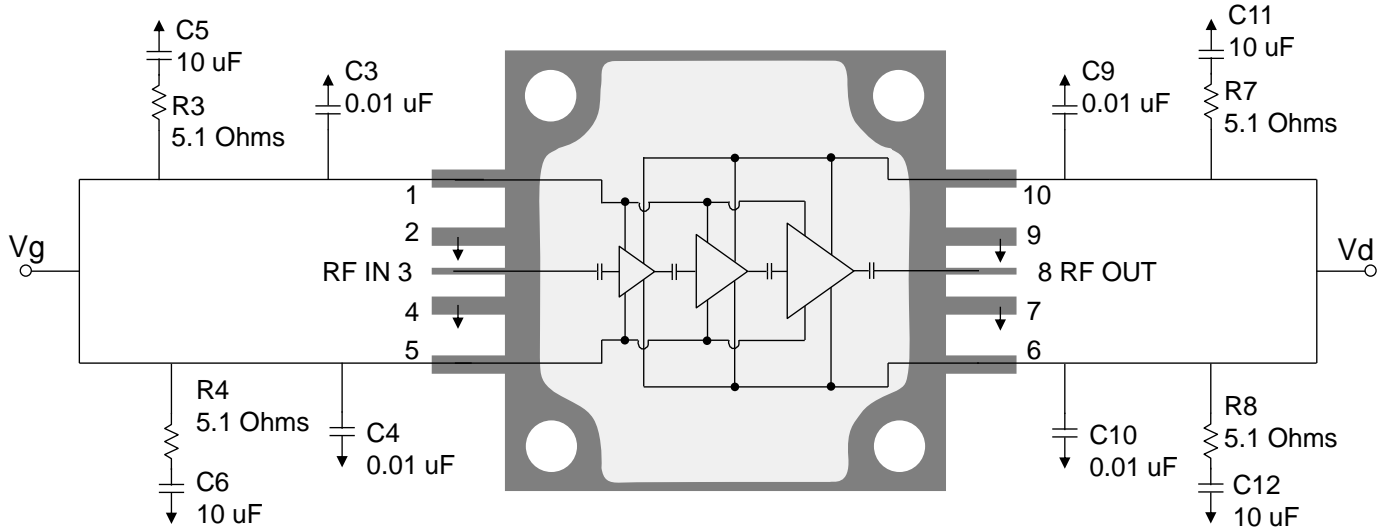

#### Bias Up Procedure

1. Set  $I_D$  limit to 8 A,  $I_G$  limit to 50 mA
2. Apply  $-5\text{ V}$  to  $V_G$
3. Apply  $+20\text{ V}$  to  $V_D$ ; ensure  $I_{DQ}$  is approx. 0 mA
4. Adjust  $V_G$  until  $I_{DQ} = 2500\text{ mA}$  ( $V_G \sim -2.3\text{ V Typ.}$ ).
5. Turn on RF supply

#### Bias Down Procedure

1. Turn off RF supply
2. Reduce  $V_G$  to  $-5\text{ V}$ ; ensure  $I_{DQ}$  is approx. 0 mA
3. Set  $V_D$  to 0 V
4. Turn off  $V_D$  supply
5. Turn off  $V_G$  supply

#### Pin Description

Pad No.	Symbol	Description
1,5	$V_G$	Gate Voltage; Bias network is required; must be biased from both sides; see recommended Application Information above.
3	$RF_{IN}$	Input; matched to $50\ \Omega$ ; DC blocked
2,4,7,9	GND	Must be grounded on the PCB.
6,10	$V_D$	Drain voltage; Bias network is required; must be biased from both sides; see recommended Application Information above.
8	$RF_{OUT}$	Output; matched to $50\ \Omega$ ; DC blocked

### Evaluation Board

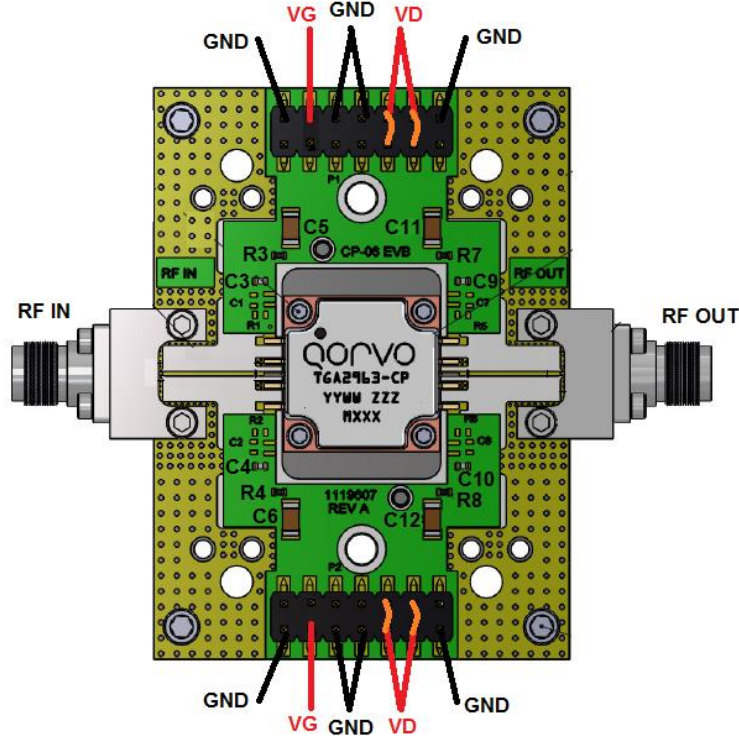

Notes:

1. Both Top and Bottom  $V_D$  and  $V_G$  must be biased.
2. We recommend to have a jumper between top and bottom of each  $V_D$  head pin as indicated above since this part is operating under high current.
3. Remove R7, R8, C10 & C11 for pulsed operation.

### Bill of Materials

Reference Des.	Value	Description	Manuf.	Part Number
C3, C4, C9, C10	0.01 $\mu$ F	Cap, 0402, 50 V, 10 %, X7R	Various	–
C5, C6, C11, C12	10 $\mu$ F	Cap, 1206, 50 V, 20 %, X5R	Various	–
R3, R4, R7, R8	5.1 Ohm	Res, 0402, 50 V, 5 %	Various	–

### Assembly Notes

1. Clean the board or module with alcohol. Allow it to dry fully.
2. Screws are recommended for mounting the TGA2963-CP to the T-Carrier.
3. To improve the thermal and RF performance, we recommend the following:
  - a. Apply thermal compound (Artic Silver) between the package and the T-Carrier.
  - b. Attach a heat sink to the bottom of the T-Carrier and apply thermal compound between the heat sink and the T-Carrier.
4. Apply solder to each pin of the TGA2963-CP.  
Clean the assembly with alcohol.

**Mechanical Information**

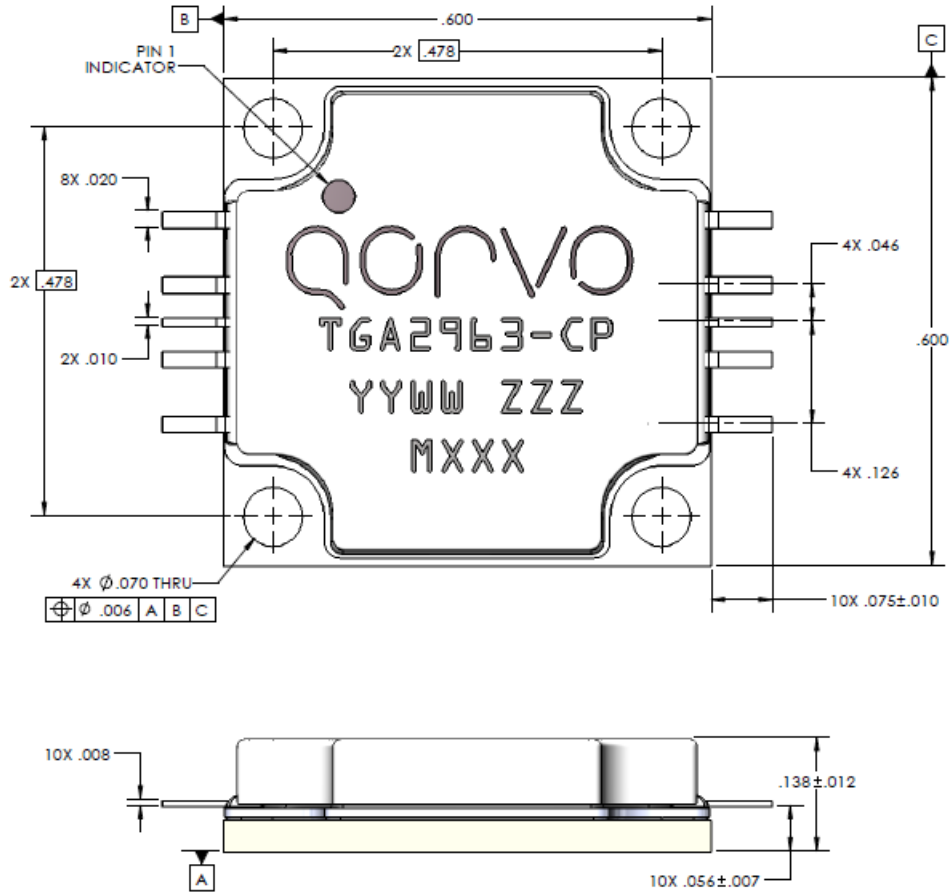

Units: inches

Tolerances: unless specified

x.xx = ± 0.01

x.xxx = ± 0.005

Materials:

Base: Copper

Lid: Plastic

All metalized features are gold plated

Part is epoxy sealed

Marking:

2963: Part number

YY: Part Assembly year

WW: Part Assembly week

ZZZ: Serial Number

MXXX: Batch ID

### Absolute Maximum Ratings

Parameter	Value / Range
Drain Voltage ( $V_D$ )	+29.5 V
Gate Voltage Range ( $V_G$ )	-8 to 0 V
Drain Current	8160 mA
Forward Gate Current ( $I_G$ )	See $I_{G\_MAX}$ plot
Power Dissipation ( $P_{DISS}$ ), 85 °C, CW	150 W
Input Power, CW, 50 $\Omega$ , ( $P_{IN}$ ), $V_D = +20$ V, $I_{DQ} = 2500$ mA, 85 °C,	30 dBm
Input Power, CW, VSWR 3:1, ( $P_{IN}$ ) $V_D = +20$ V, $I_{DQ} = 2500$ mA, 85 °C	30 dBm
Channel Temperature ( $T_{CH}$ )	275 °C
Mounting Temperature (30 Seconds)	260 °C
Storage Temperature	-55 to 150 °C

Operation of this device outside the parameter ranges given above may cause permanent damage. These are stress ratings only, and functional operation of the device at these conditions is not implied.

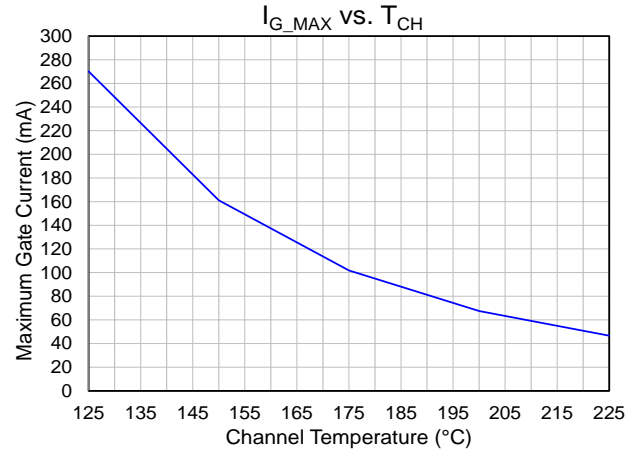



### Handling Precautions

Parameter	Rating	Standard
ESD – Human Body Model (HBM)	TBD	ESDA / JEDEC JS-001-2012
MSL – Moisture Sensitivity Level	TBD	IPC/JEDEC J-STD-020



Caution!  
ESD-Sensitive Device

### Solderability

Compatible with both lead-free (260°C max. reflow temp.) and tin/lead (245°C max. reflow temp.) soldering processes. Solder profiles available upon request.

### RoHS Compliance

This product is compliant with the 2011/65/EU RoHS directive (Restrictions on the Use of Certain Hazardous Substances in Electrical and Electronic Equipment), as amended by Directive 2015/863/EU. This product also has the following attributes:

- Lead Free
- Halogen Free (Chlorine, Bromine)
- Antimony Free
- TBBP-A (C<sub>15</sub>H<sub>12</sub>Br<sub>4</sub>O<sub>2</sub>) Free
- PFOS Free
- SVHC Free
- Qorvo Green



### Contact Information

For the latest specifications, additional product information, worldwide sales and distribution locations:

**Tel:** 1-844-890-8163

**Web:** [www.qorvo.com](http://www.qorvo.com)

**Email:** [customer.support@qorvo.com](mailto:customer.support@qorvo.com)

For technical questions and application information: **Email:** [sicapplications.engineering@qorvo.com](mailto:sicapplications.engineering@qorvo.com)

### Important Notice

The information contained herein is believed to be reliable. Qorvo makes no warranties regarding the information contained herein. Qorvo assumes no responsibility or liability whatsoever for any of the information contained herein. Qorvo assumes no responsibility or liability whatsoever for the use of the information contained herein. The information contained herein is provided "AS IS, WHERE IS" and with all faults, and the entire risk associated with such information is entirely with the user. All information contained herein is subject to change without notice. Customers should obtain and verify the latest relevant information before placing orders for Qorvo products. The information contained herein or any use of such information does not grant, explicitly or implicitly, to any party any patent rights, licenses, or any other intellectual property rights, whether with regard to such information itself or anything described by such information.

Qorvo products are not warranted or authorized for use as critical components in medical, life-saving, or life-sustaining applications, or other applications where a failure would reasonably be expected to cause severe personal injury or death.

Copyright 2016 © Qorvo, Inc. | Qorvo is a registered trademark of Qorvo, Inc.