

Product Description

Qorvo's TGA2963-CP is a broadband high power MMIC amplifier fabricated on Qorvo's production 0.15um GaN on SiC process (QGaN15). The TGA2963-CP operates from 6 – 18 GHz and typically provides 20 W saturated output power with power-added efficiency of 20% and large-signal gain of 18 dB. This combination of wideband performance provides the flexibility designers are looking for to improve system performance while reducing size and cost.

The TGA2963-CP is offered in a 10-lead 15 x 15 mm bolt-down package. Assembled with a pure-copper base, coupled with its high efficiency, the TGA2963-CP minimizes the strain on the system-level cooling requirements, further reducing system operating costs. The broadband performance makes it ideally suited to support test instrumentation and electronic warfare, as well as, supporting multiple radar and communication bands.

Both RF ports have integrated DC blocking capacitors and are fully matched to 50 Ohms.

RoHS compliant.

Functional Block Diagram

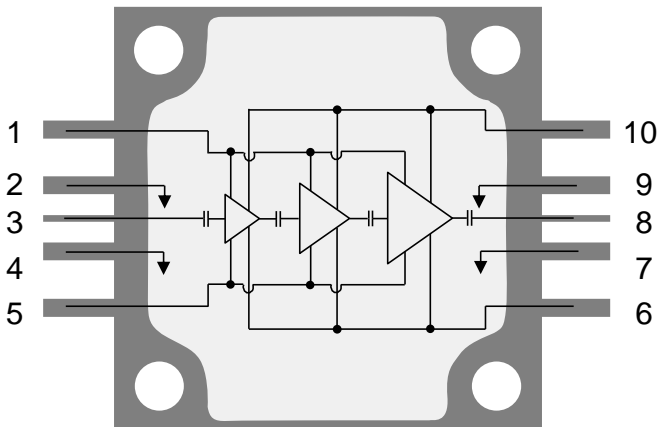

Product Features

- Frequency Range: 6 – 18 GHz
- P_{OUT} : 43 dBm @ $P_{IN} = 25$ dBm
- PAE: 20 % @ $P_{IN} = 25$ dBm
- Large Signal Gain: 18 dB @ $P_{IN} = 25$ dBm
- Small Signal Gain: 26 dB
- Bias: $V_D = +20$ V, $I_{DQ} = 2500$ mA, $V_G = -2.3$ V Typical
- Process Technology: QGaN15
- Package Dimensions: 15.2 x 15.2 x 3.5 mm
- Package base is pure Cu offering superior thermal management

Performance is typical across frequency. Please reference electrical specification table and data plots for more details.

Applications

- Test Instrumentation
- Electronic Warfare (EW)
- Radar
- Communications

Ordering Information

Part No.	Description
TGA2963-CP	6 – 18 GHz 20 W GaN Power Amplifier

Absolute Maximum Ratings

Parameter	Value / Range
Drain Voltage (V_D)	+29.5 V
Gate Voltage Range (V_G)	-8 to 0 V
Drain Current	8160 mA
Forward Gate Current (I_G)	See I_{G_MAX} plot
Power Dissipation (P_{DISS}), 85 °C, CW	150 W
Input Power (P_{IN}): CW, 50 Ω , $V_D = +20$ V, $I_{DQ} = 2500$ mA, 85 °C	30 dBm
Input Power (P_{IN}): CW, VSWR 3:1, $V_D = +20$ V, $I_{DQ} = 2500$ mA, 85 °C	30 dBm
Mounting Temperature	Refer to Assembly Notes, page 15
Storage Temperature	-55 to 150 °C

Operation of this device outside the parameter ranges given above may cause permanent damage. These are stress ratings only, and functional operation of the device at these conditions is not implied.

Electrical Specifications

Test conditions unless otherwise noted: 25 °C, $V_D = +20$ V, $I_{DQ} = 2500$ mA, CW

Parameter		Min	Typ	Max	Units
Operational Frequency Range		6	–	18	GHz
Output Power @ $P_{IN} = 25$ dBm	Frequency = 6 GHz		42.8	–	dBm
	Frequency = 12 GHz		45	–	
	Frequency = 18 GHz		43	–	
Power Added Efficiency @ $P_{IN} = 25$ dBm	Frequency = 6 GHz		21	–	%
	Frequency = 12 GHz		24	–	
	Frequency = 18 GHz		18	–	
Small Signal Gain	Frequency = 6 GHz		28	–	dB
	Frequency = 12 GHz		34	–	
	Frequency = 18 GHz		24	–	
Input Return Loss	Frequency = 6 GHz		16	–	dB
	Frequency = 12 GHz		12	–	
	Frequency = 18 GHz		9	–	
Output Return Loss	Frequency = 6 GHz		10	–	dB
	Frequency = 12 GHz		7.7	–	
	Frequency = 18 GHz		6.7	–	
Small Signal Gain Temperature Coefficient		–	-0.08	–	dB/°C
Output Power Temperature Coefficient		–	-0.015	–	dBm/°C
Gate Leakage ($V_D = 10$ V, $V_G = -3.7$ V)		-21.6			mA

Recommended Operating Conditions

Parameter	Value / Range
Drain Voltage (V_D)	+20 V
Drain Current (I_{DQ})	2500 mA
Gate Voltage (V_G)	-2.9 to -2.0 V (Typ.)
Temperature (T_{BASE})	-40 to 85 °C

Electrical specifications are measured at specified test conditions. Specifications are not guaranteed over all recommended operating conditions.

Performance Plots – Large Signal (CW)

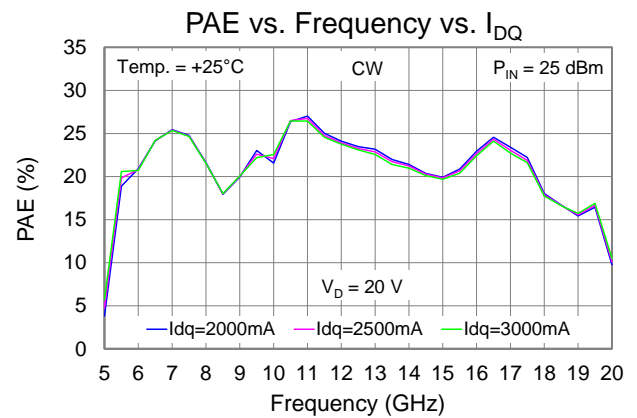
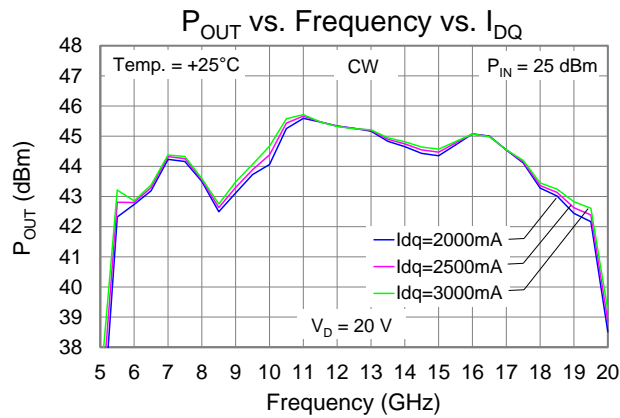
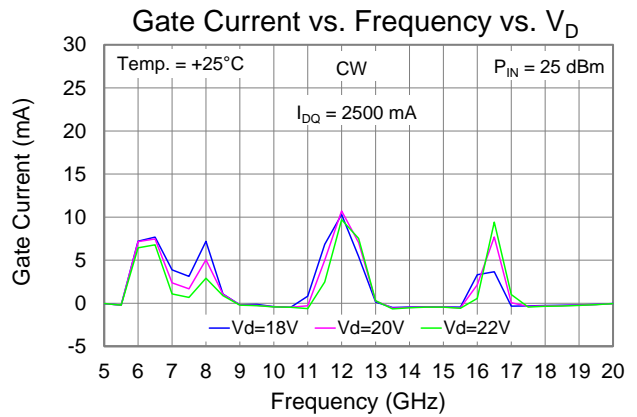
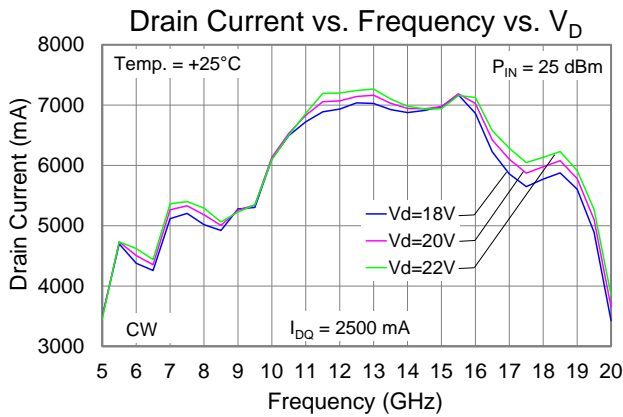
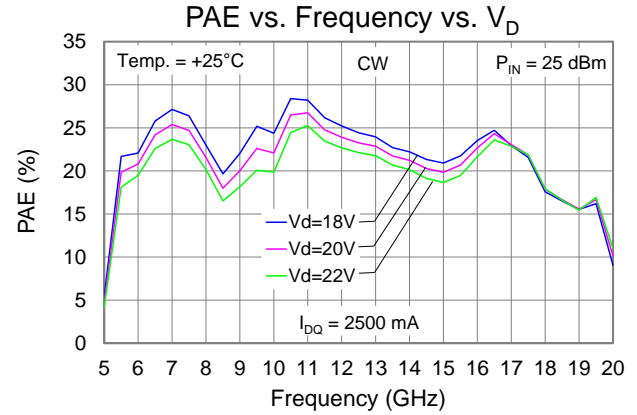
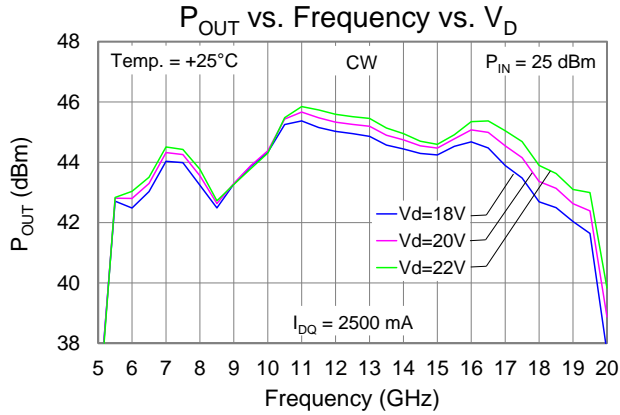

Performance Plots – Large Signal (CW)

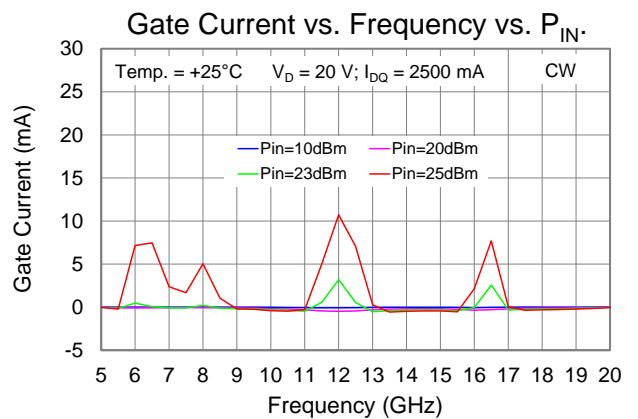
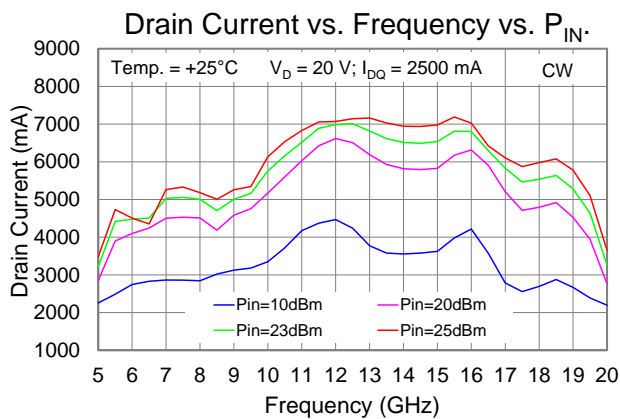
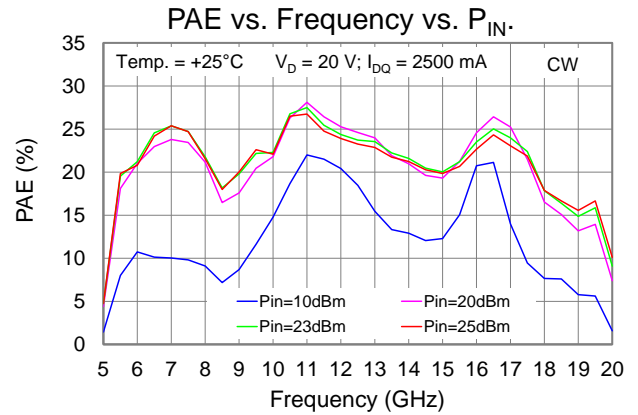
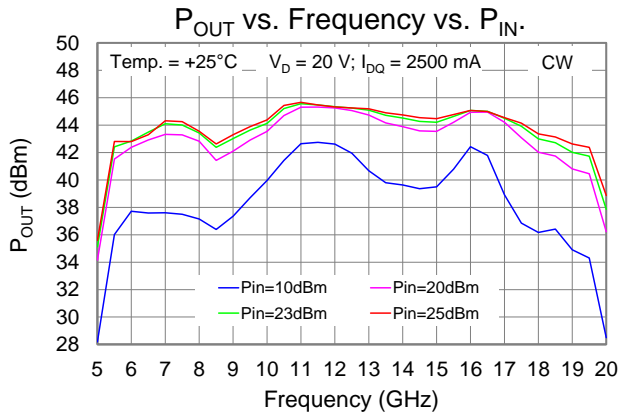
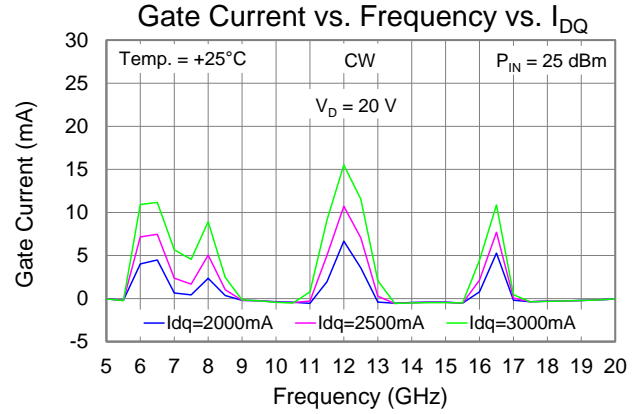
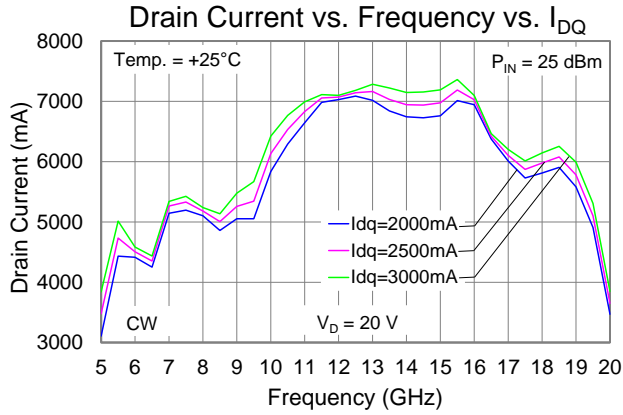

Performance Plots – Large Signal (CW)

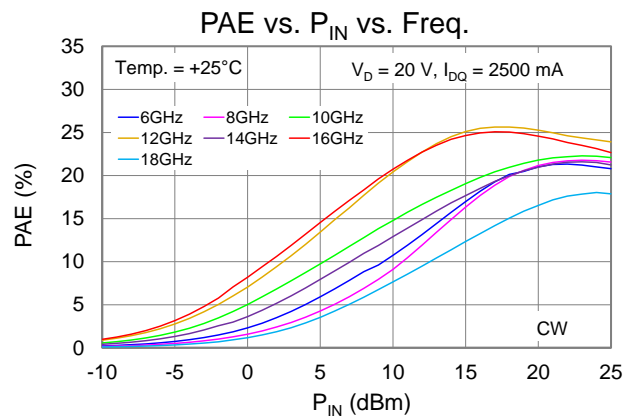
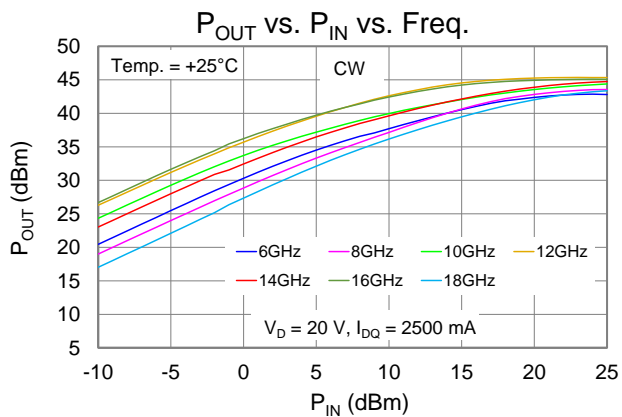
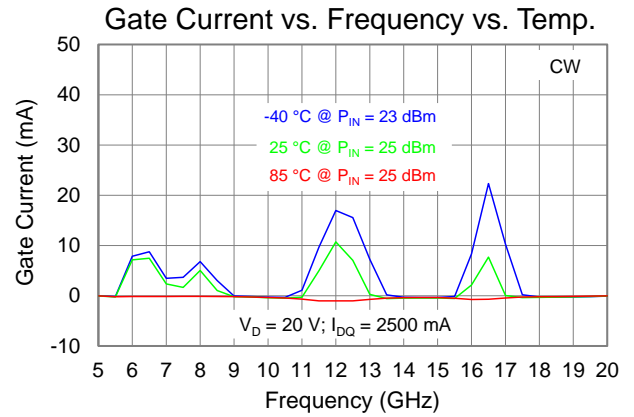
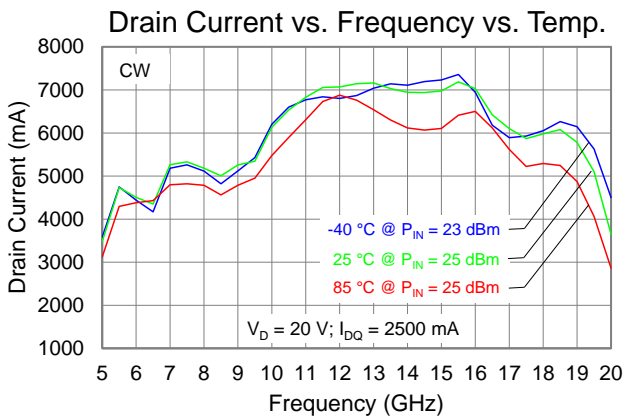
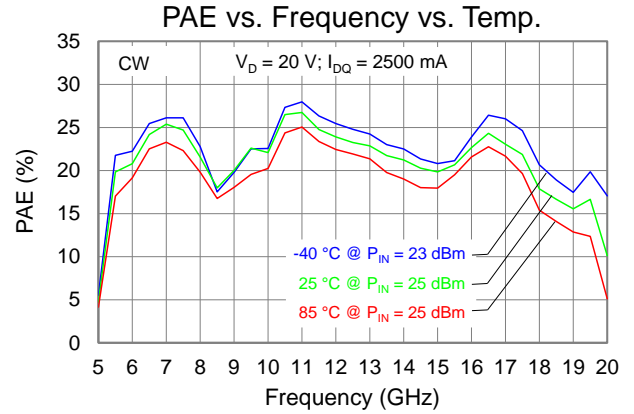
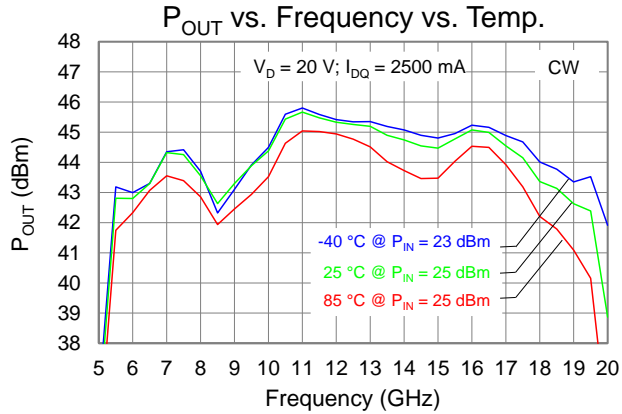

Performance Plots – Large Signal (CW)

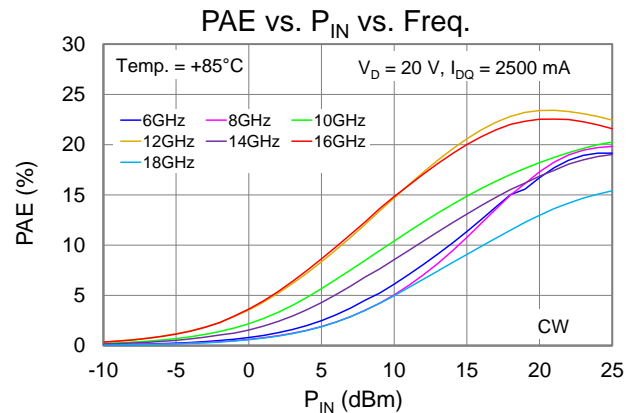
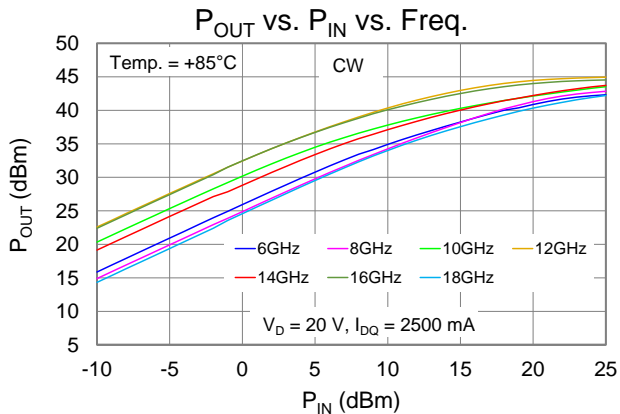
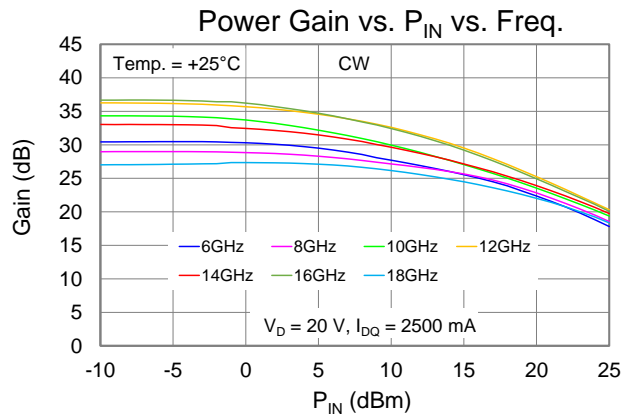
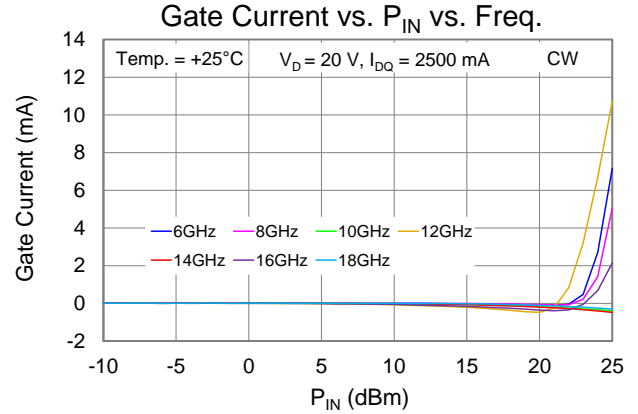
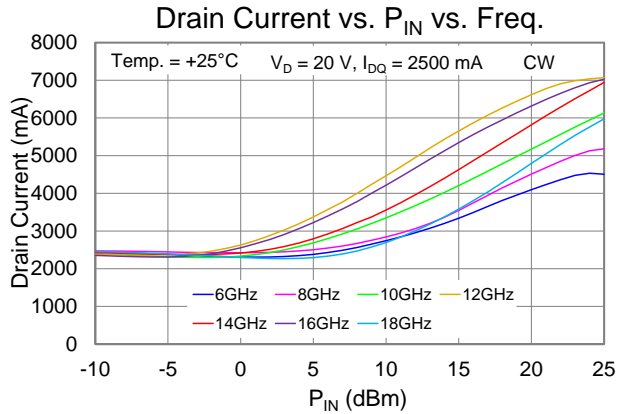

Performance Plots – Large Signal (Pulsed)

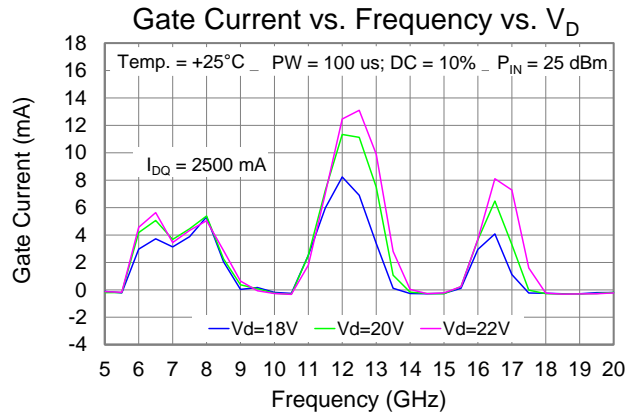
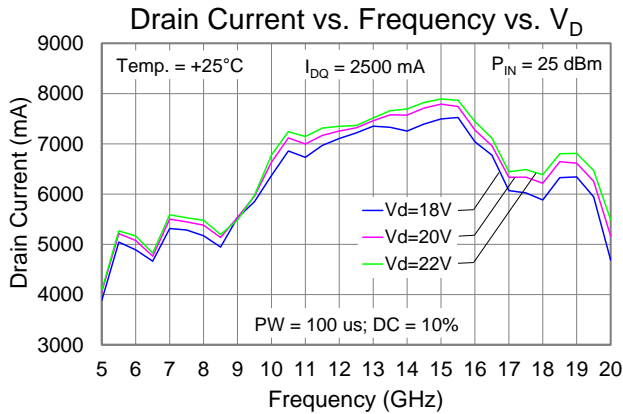
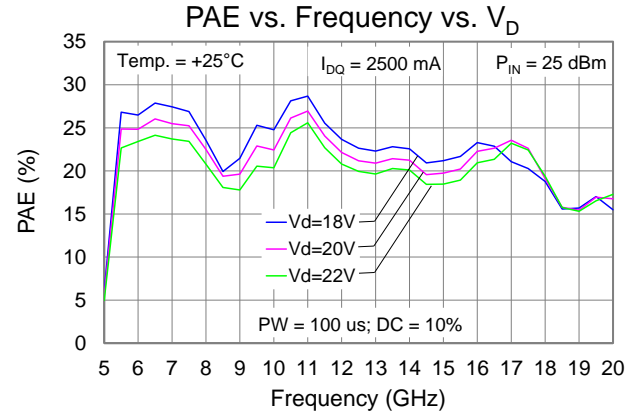
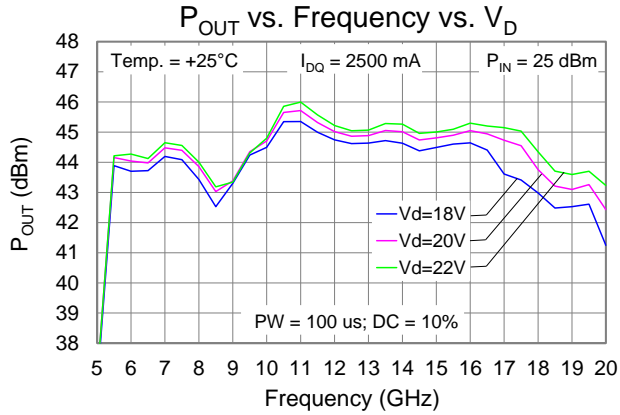

Performance Plots – Linearity

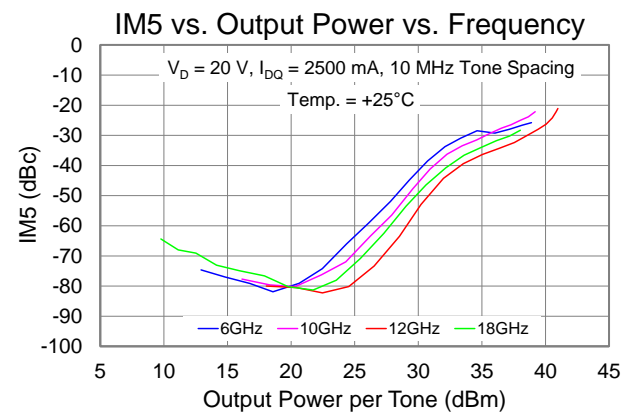
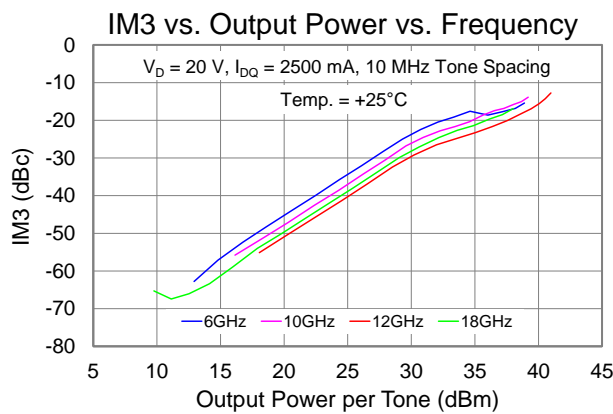
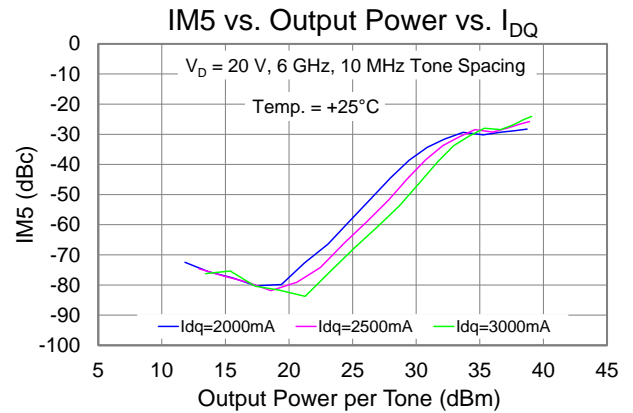
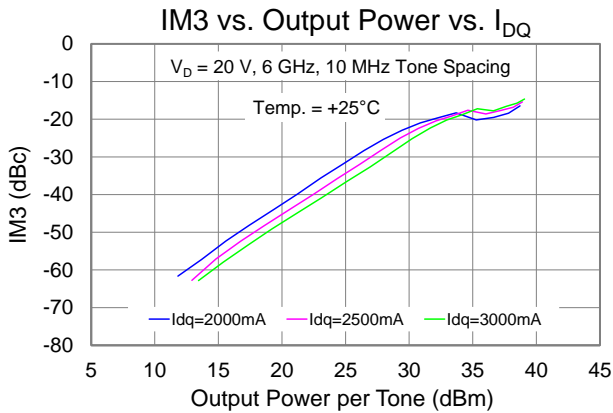
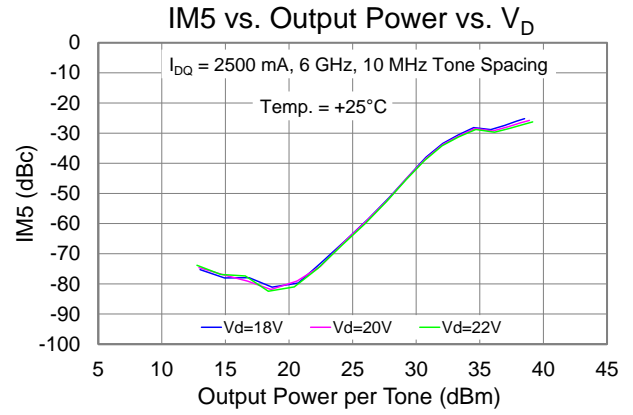
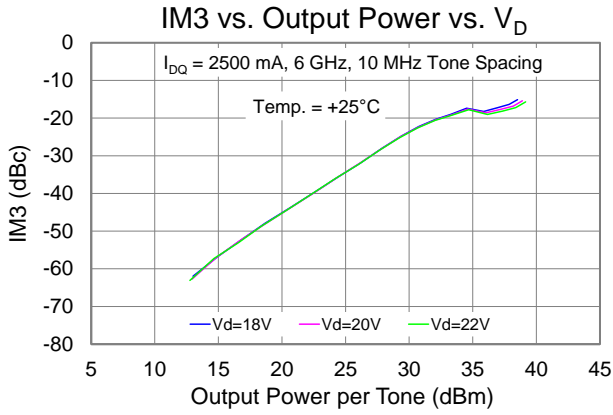

Performance Plots – Linearity

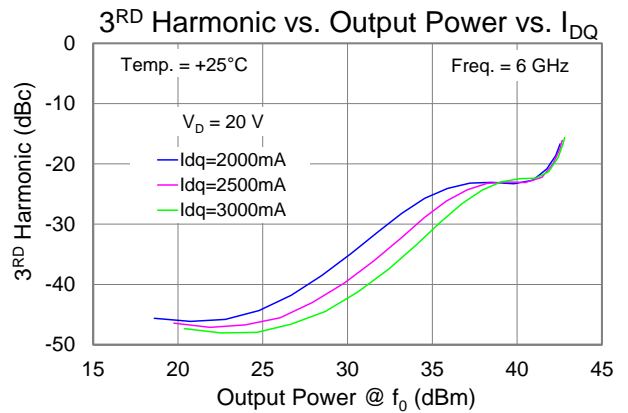
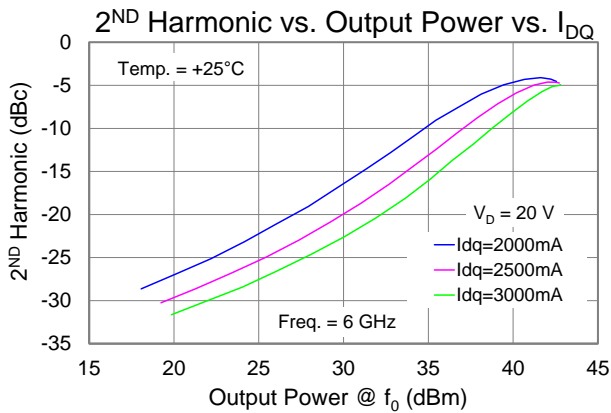
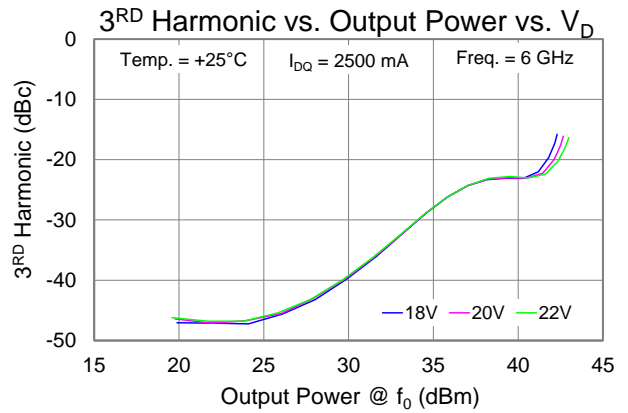
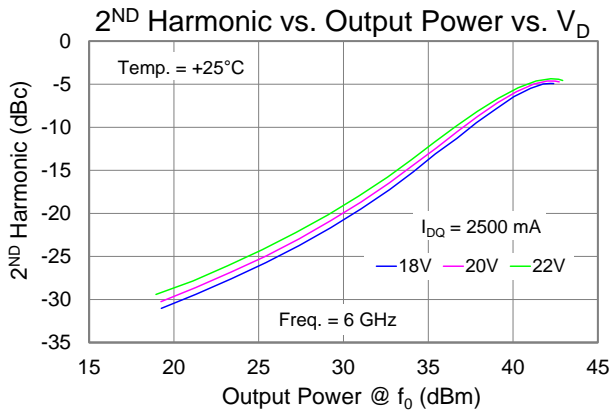
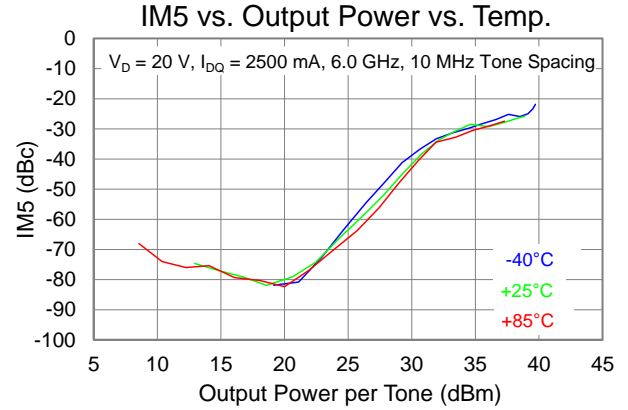
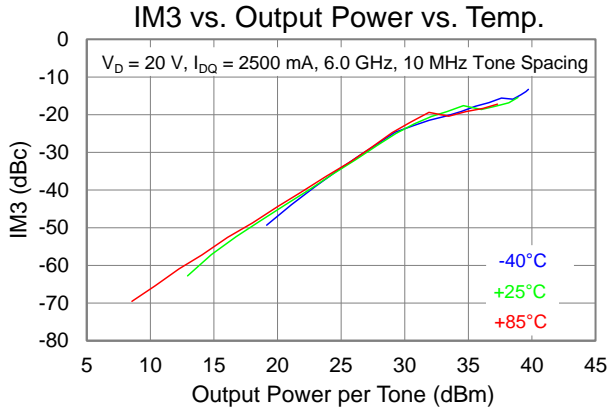

Performance Plots – Linearity

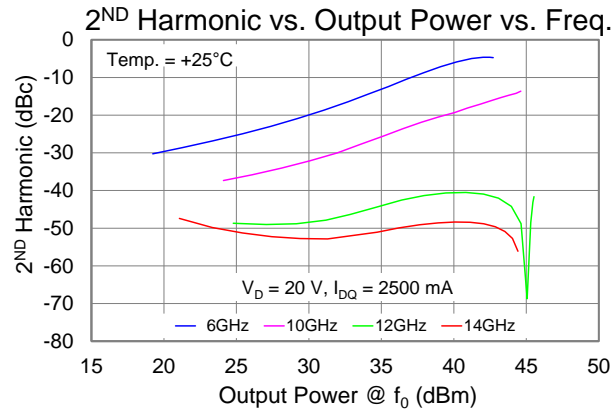
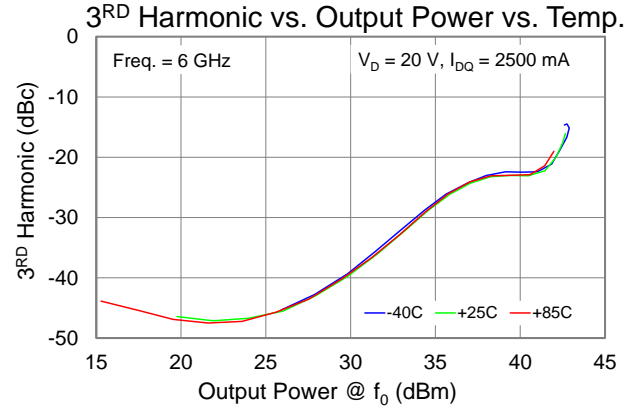
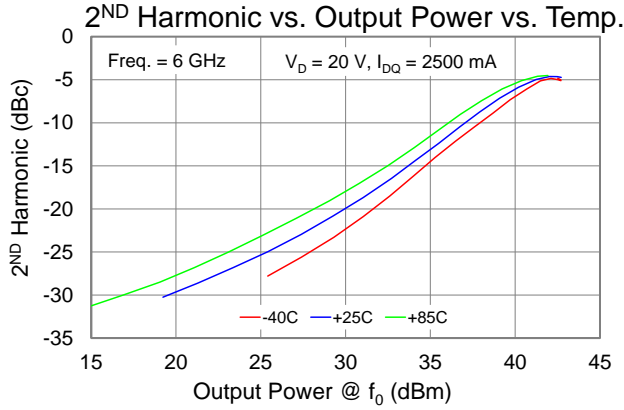

Performance Plots – Small Signal

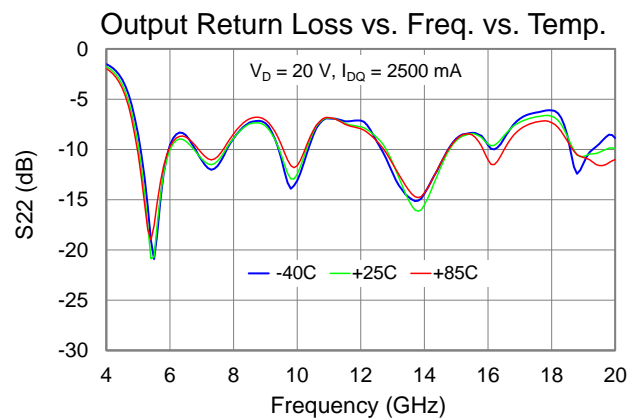
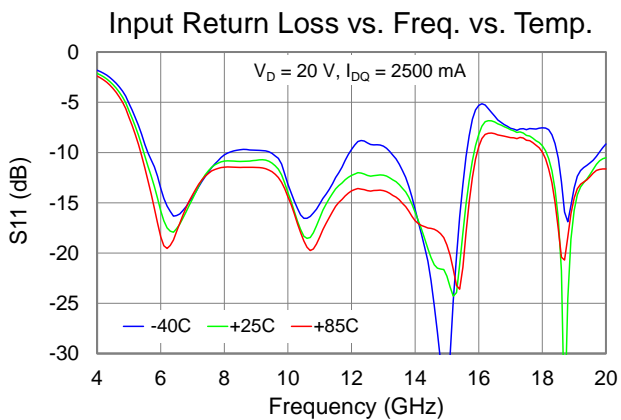
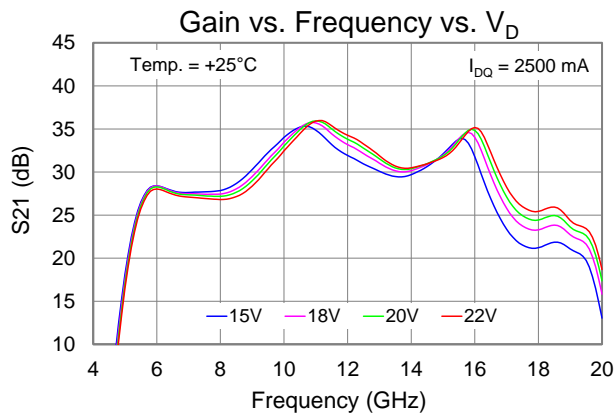
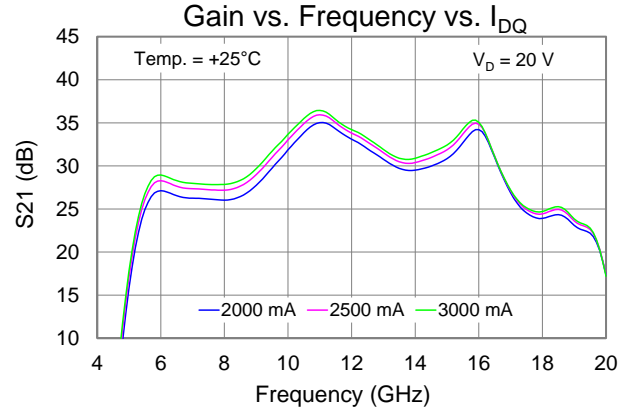
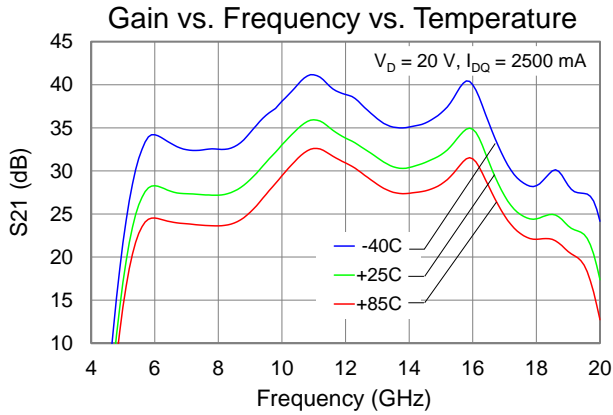

Thermal and Reliability Information

Parameter	Test Conditions	Value	Units
Thermal Resistance (θ_{JC}) ⁽¹⁾	$T_{BASE} = 85^\circ\text{C}$, $V_D = +20\text{ V (CW)}$, $I_{DQ} = 2500\text{ mA}$, $P_{DISS} = 50\text{ W (No RF drive)}$	0.76	$^\circ\text{C/W}$
Channel Temperature (T_{CH}) (Quiescent)		123	$^\circ\text{C}$
Thermal Resistance (θ_{JC}) ⁽¹⁾	$T_{BASE} = 85^\circ\text{C}$, $V_D = +20\text{ V (CW)}$, Freq = 12 GHz, $P_{IN} = 25\text{ dBm}$, $I_{DQ} = 2500\text{ mA}$, $I_{D_Drive} = 6.9\text{ A}$, $P_{OUT} = 45\text{ dBm}$, $P_{DISS} = 107\text{ W}$	0.85	$^\circ\text{C/W}$
Channel Temperature (T_{CH}) (Under RF drive)		176	$^\circ\text{C}$
Thermal Resistance (θ_{JC}) ⁽¹⁾	$T_{BASE} = 85^\circ\text{C}$, $V_D = +22\text{ V (CW)}$, Freq = 12 GHz, $P_{IN} = 25\text{ dBm}$, $I_{DQ} = 2500\text{ mA}$, $I_{D_Drive} = 7\text{ A}$, $P_{OUT} = 45\text{ dBm}$, $P_{DISS} = 120\text{ W}$	0.87	$^\circ\text{C/W}$
Channel Temperature (T_{CH}) (Under RF drive)		189	$^\circ\text{C}$

Notes:

1. Thermal resistance measured to back of package.
2. Refer to the following document: [GaN Device Channel Temperature, Thermal Resistance, and Reliability Estimates](#)

Power Dissipation and Maximum Gate Current

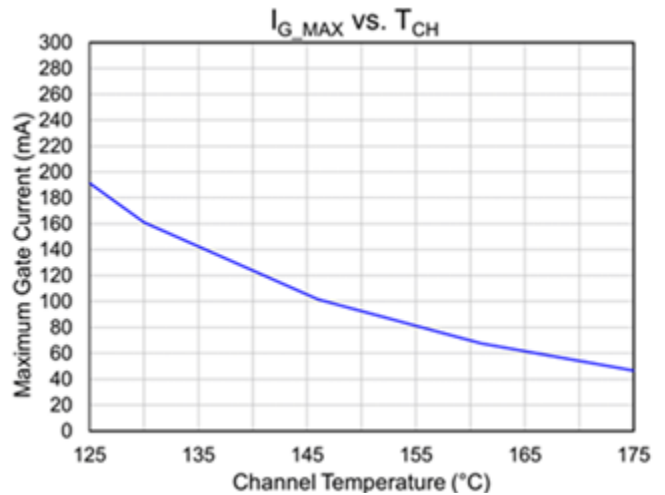
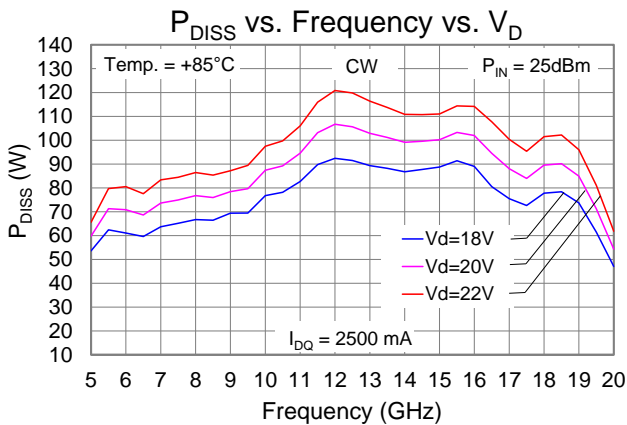

Applications Information and Pad Layout

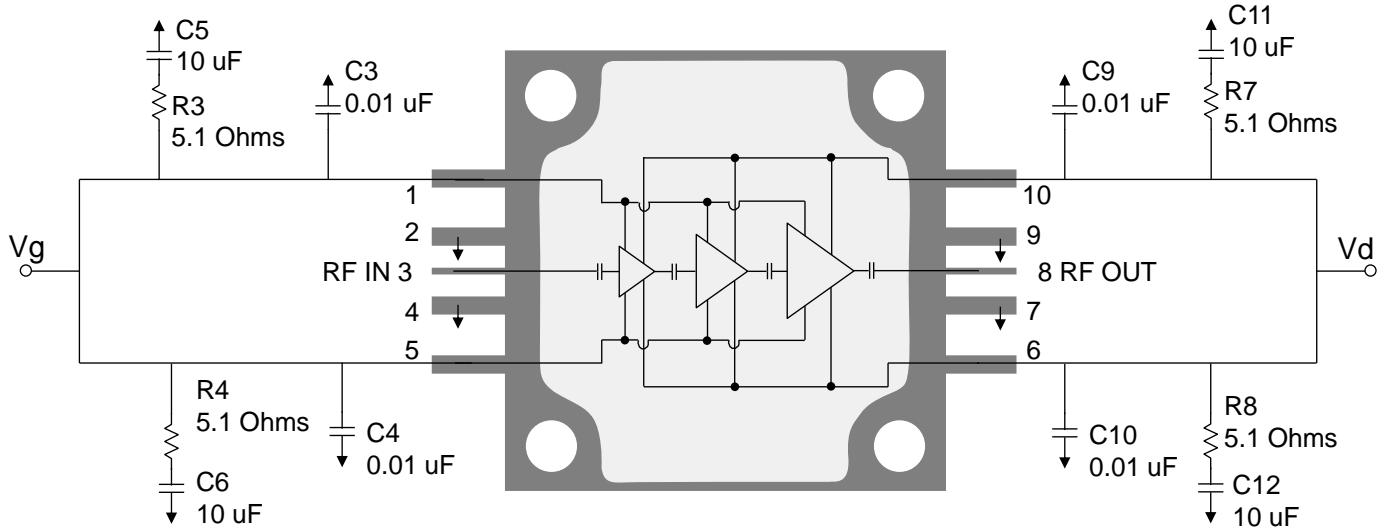

Bias Up Procedure

1. Set I_D limit to 8 A, I_G limit to 50 mA
2. Apply -5 V to V_G
3. Apply $+20\text{ V}$ to V_D ; ensure I_{DQ} is approx. 0 mA
4. Adjust V_G until $I_{DQ} = 2500\text{ mA}$ ($V_G \sim -2.3\text{ V Typ.}$).
5. Turn on RF supply

Bias Down Procedure

1. Turn off RF supply
2. Reduce V_G to -5 V ; ensure I_{DQ} is approx. 0 mA
3. Set V_D to 0 V
4. Turn off V_D supply
5. Turn off V_G supply

Pin Description

Pad No.	Symbol	Description
1,5	V_G	Gate voltage. Bias network is required; must be biased from both sides; see recommended Application Information above.
3	RF_{IN}	Input; matched to $50\ \Omega$; DC blocked
2,4,7,9	GND	Must be grounded on the PCB.
6,10	V_D	Drain voltage. Bias network is required; must be biased from both sides; see recommended Application Information above.
8	RF_{OUT}	Output; matched to $50\ \Omega$; DC blocked

Evaluation Board

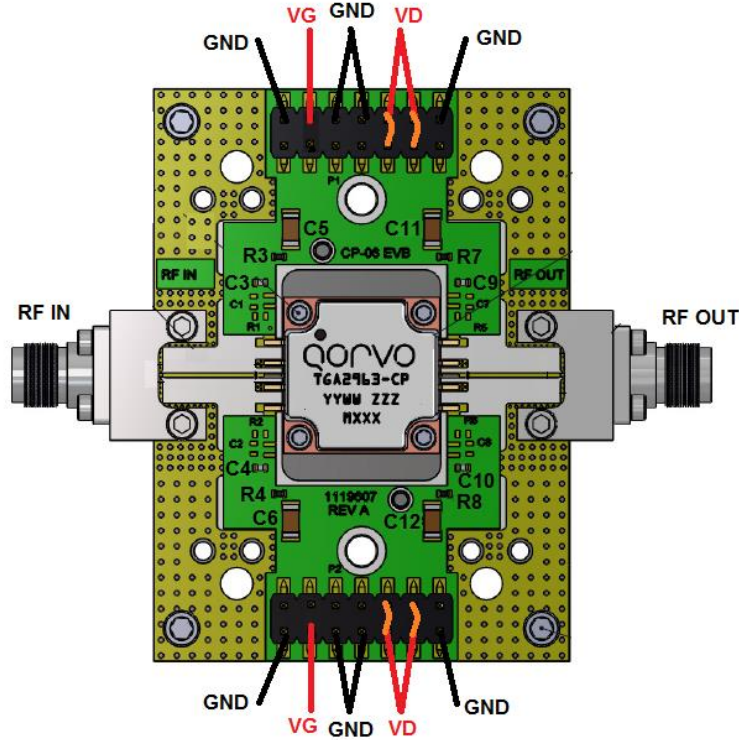

Notes:

1. Both Top and Bottom V_D and V_G must be biased.
2. Remove R7, R8, C11 & C12 for pulsed operation.

Bill of Materials

Reference Des.	Value	Description	Manuf.	Part Number
C3, C4, C9, C10	0.01 μ F	CAP, 0.01uF, 10%, 50V, X7R, 0402	Various	–
C5, C6, C11, C12	10 μ F	CAP, 10uF, 20%, 50V, 20%, X5R, 1206	Various	–
R3, R4, R7, R8	5.1 Ohm	RES, 5.1 OHM, 5%, 50V, 0402	Various	–
J1, J2	2.92 mm	RF Connector, F, 2.92 mm	Southwest Microwave	1092-01A-5

Assembly Notes

1. Carefully clean the PC board, base plate, and package leads with alcohol. Allow it to dry fully.
2. To improve the thermal and RF performance, Qorvo recommends attaching a heat sink to the bottom of the package and apply either a thermal compound (Arctic Silver 5 recommended) or a .004 inch (maximum thickness) Indium shim between the heat sink and the package. Refer to the applications note [Application of Arctic Silver 5 Thermal Compound and Indium Shims for Qorvo CP-style Packaged Components](#) for more information.
3. The component leads should be manually soldered. Apply a low residue solder alloy meeting J-STD-001 (ROLO, ROL1 or equivalent) with a liquidus temperature below 220 °C to each pin of the TGA2963-CP. The use of low residue/no-clean flux (ROLO, ROL1) is recommended. The package lead temperature should not exceed 260 deg C. Each solder connection should be completed within 2 to 5 seconds. Adding flux during hand soldering of the component leads with localized spot cleaning is acceptable. Soldering irons meeting the requirements of J-STD-001, Appendix A are acceptable.
4. The leads should be soldered in a staggered or star pattern from side to side, and never solder two adjacent leads. This allows the heat to dissipate on each lead, and not cause the adjacent leads to become de-soldered and damaged or displaced.



5. The packaged part should not be subjected to conventional SMT automated solder reflow processes.
6. (The following is for information only. There are many variables in a second level assembly that Qorvo does not control, so Qorvo does not recommend an absolute torque value.) Use screws to attach the component to the heat sink. A suggested final torque value is 16 in-oz. for a 0-80 screw. Start with screws finger tight, then torque to 8 in-oz., then torque to final value. Use the following tightening pattern:

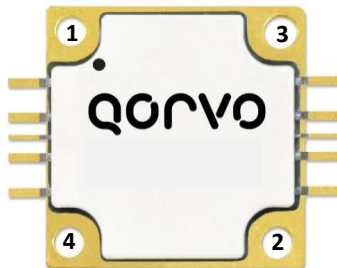

Mechanical Information

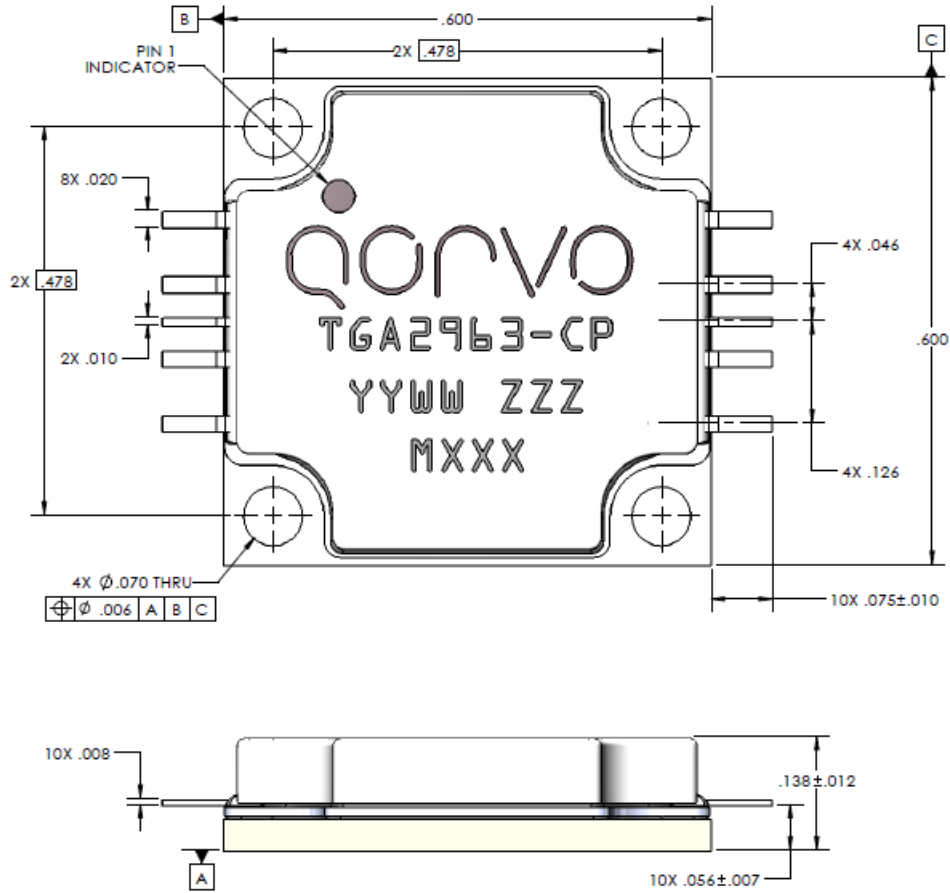

Units: inches

Tolerances: unless specified

x.xx = ± 0.01

x.xxx = ± 0.005

Materials:

Base: Copper

Lid: Plastic

All metalized features are gold plated

Part is epoxy sealed

Marking:

2963: Part number

YY: Part Assembly year

WW: Part Assembly week

ZZZ: Serial Number

MXXX: Batch ID

Handling Precautions

Parameter	Rating	Standard
ESD – Human Body Model (HBM)	TBD	ESDA / JEDEC JS-001-2012
MSL – Moisture Sensitivity Level	N/A	



Caution!
ESD-Sensitive Device

Solderability

The component leads should be manually soldered, and the package cannot be subjected to conventional reflow processes. The use of no-clean solder to avoid washing after soldering is recommended.

RoHS Compliance

This product is compliant with the 2011/65/EU RoHS directive (Restrictions on the Use of Certain Hazardous Substances in Electrical and Electronic Equipment), as amended by Directive 2015/863/EU. This product also has the following attributes:

- Product uses RoHS Exemption 7c-1 to meet RoHS Compliance requirements
- Halogen Free (Chlorine, Bromine)
- Antimony Free
- TBBP-A (C₁₅H₁₂Br₄O₂) Free
- PFOS Free
- SVHC Free

Contact Information

For the latest specifications, additional product information, worldwide sales and distribution locations:

- Web:** www.qorvo.com
Tel: 1-844-890-8163
Email: customer.support@qorvo.com

Important Notice

The information contained herein is believed to be reliable; however, Qorvo makes no warranties regarding the information contained herein and assumes no responsibility or liability whatsoever for the use of the information contained herein. All information contained herein is subject to change without notice. Customers should obtain and verify the latest relevant information before placing orders for Qorvo products. The information contained herein or any use of such information does not grant, explicitly or implicitly, to any party any patent rights, licenses, or any other intellectual property rights, whether with regard to such information itself or anything described by such information. **THIS INFORMATION DOES NOT CONSTITUTE A WARRANTY WITH RESPECT TO THE PRODUCTS DESCRIBED HEREIN, AND QORVO HEREBY DISCLAIMS ANY AND ALL WARRANTIES WITH RESPECT TO SUCH PRODUCTS WHETHER EXPRESS OR IMPLIED BY LAW, COURSE OF DEALING, COURSE OF PERFORMANCE, USAGE OF TRADE OR OTHERWISE, INCLUDING THE IMPLIED WARRANTIES OF MERCHANTABILITY AND FITNESS FOR A PARTICULAR PURPOSE.**

Without limiting the generality of the foregoing, Qorvo products are not warranted or authorized for use as critical components in medical, life-saving, or life-sustaining applications, or other applications where a failure would reasonably be expected to cause severe personal injury or death.

© 2023 Qorvo US, Inc. All rights reserved. This document is subject to copyright laws in various jurisdictions worldwide and may not be reproduced or distributed, in whole or in part, without the express written consent of Qorvo US, Inc.