

### Applications

- Communications
- Electronic Warfare
- Test Instrumentation
- EMC Amplifier

### Product Features

- Frequency Range: 2.5 to 6 GHz
- $P_{SAT}$ : 46.5 dBm @  $P_{IN} = 26dBm$ , CW
- PAE: 36%
- Small Signal Gain: 29 dB
- Bias:  $V_D = 30$  V,  $I_{DQ} = 1.55$  A,  $V_G = -2.5$  V Typical
- Dimensions: 11.4 x 17.3 x 3.0 mm.

### General Description

TriQuint's TGA2576-2-FL is a wideband power amplifier fabricated on TriQuint's proven 0.25um GaN on SiC production technology. Operating from 2.5 to 6 GHz, the TGA2576-2-FL achieves 40W of saturated output power, greater than 36% power-added efficiency and 29dB small signal gain.

For ideal thermal management and handling, the TGA2576-2-FL is offered in a CuW-based flanged packaged and can operate in both CW and pulsed modes.

Fully matched to 50Ω and with integrated DC blocking caps on both I/O ports, the TGA2576-2-FL is ideally suited to support a variety of commercial and defense related applications.

Lead-free and RoHS compliant

Evaluation Boards are available up on request.

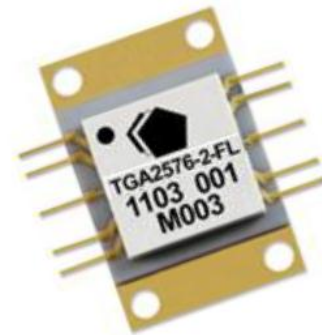

### Functional Block Diagram

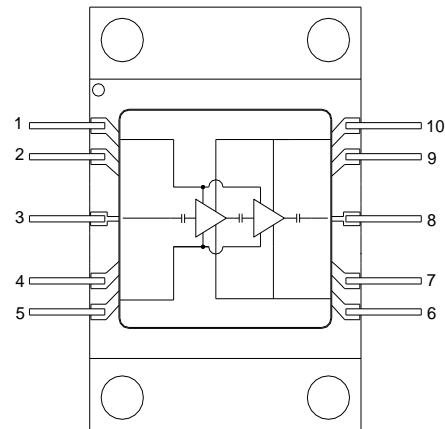

### Pin Configuration

Pin No.	Symbol
1, 5	$V_G$
2, 4, 7, 9	N/C
3	RF IN
6, 10	$V_D$
8	RF OUT

### Ordering Information

Part	ECCN	Description
TGA2576-2-FL	3A001.b.2.a	2.5 to 6GHz 40W GaN PA

### Absolute Maximum Ratings

Parameter	Value
Drain Voltage ( $V_D$ )	40 V
Gate Voltage ( $V_G$ )	-5 to 0 V
Drain Current ( $I_D$ )	5000 mA
Gate Current ( $I_G$ )	-18 to 35 mA
Power Dissipation ( $P_{DISS}$ )	93 W
RF Input Power, CW, 50 $\Omega$ , T = 25°C	28 dBm
Channel temperature ( $T_{CH}$ )	275°C
Mounting Temperature (30 Seconds)	260°C
Storage Temperature	-40 to 150°C

Operation of this device outside the parameter ranges given above may cause permanent damage. These are stress ratings only, and functional operation of the device at these conditions is not implied.

### Recommended Operating Conditions

Parameter	Value
Drain Voltage ( $V_D$ )	30 V
Drain Current ( $I_{DQ}$ )	1550 mA
Drain Current Under RF Drive ( $I_{D\_DRIVE}$ )	4300 mA
Gate Voltage ( $V_G$ )	-2.5 V

Electrical specifications are measured at specified test conditions. Specifications are not guaranteed over all operating conditions.

### Electrical Specifications

Test conditions unless otherwise noted: 25°C,  $V_D = 30$  V,  $I_{DQ} = 1550$  mA,  $V_G = -2.5$  V Typical, CW

Parameter	Min	Typical	Max	Units
Operational Frequency Range	2.5		6	GHz
Small Signal Gain		29		dB
Output Power at Saturation (Pin = 26 dBm)		46.5		dBm
Power-Added Efficiency (Pin = 26 dBm)		36 (Mid-band)		%
Gain Temperature Coefficient		-0.02		dB/°C
Power Temperature Coefficient		-0.02		dBm/°C

### Thermal and Reliability Information

Parameter	Test Conditions	Value	Units
Thermal Resistance ( $\theta_{JC}$ ) <sup>(1)</sup>	$T_{BASE} = 85^{\circ}C$	2.04	$^{\circ}C/W$
Channel Temperature Under RF Drive ( $T_{CH}$ )	$V_D = 30 V, I_{D\_Drive} = 3600 mA, P_{OUT} = 46 dBm, P_{DISS} = 68 W$	224	$^{\circ}C$
Median Lifetime Under RF Drive ( $T_M$ )		$1.69 \times 10^6$	Hours

Notes:

1. Measured from junction to center of package backside.

### Median Lifetime

Test Conditions:  $V_D = 40V$ ; Failure Criteria is 10% reduction in  $I_{D\_MAX}$

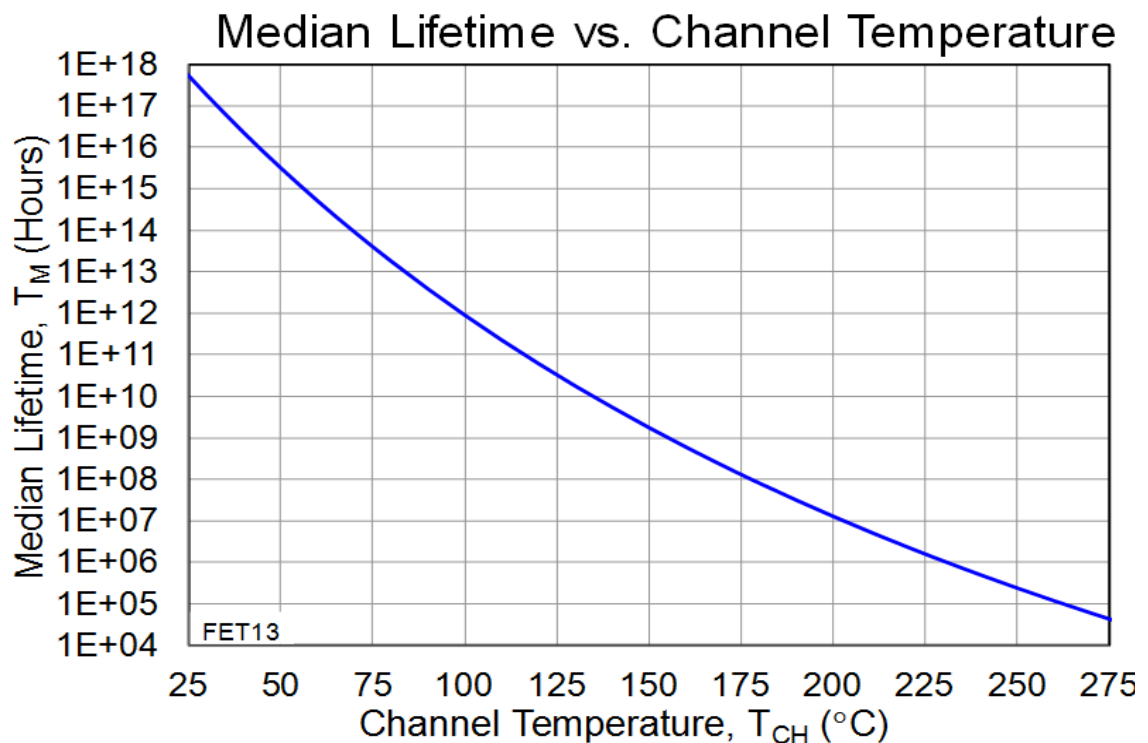

### Typical Performance

Conditions unless otherwise specified:  $V_D = 30V$ ,  $I_{DQ} = 1.55A$ ,  $V_G = -2.5V$  Typical, CW

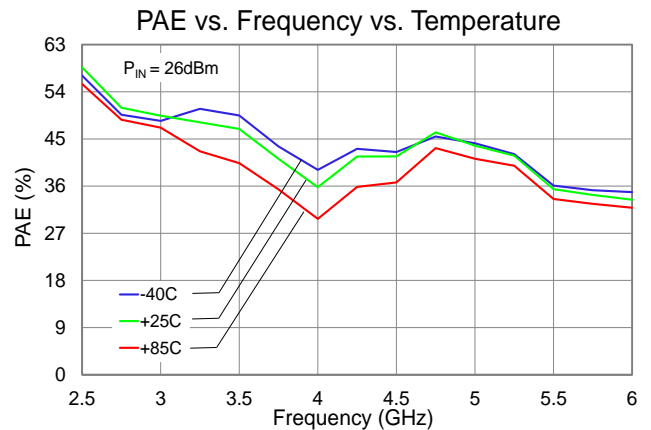
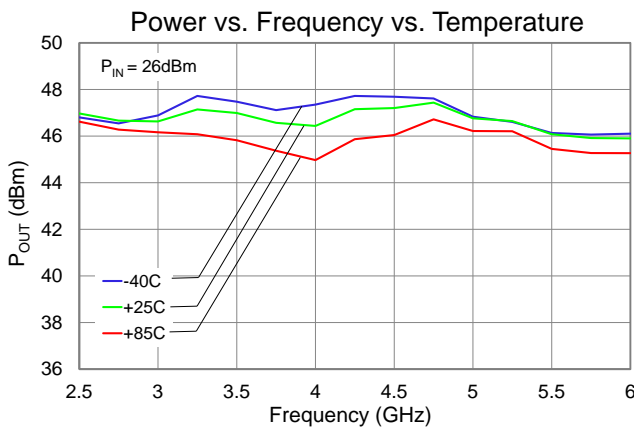
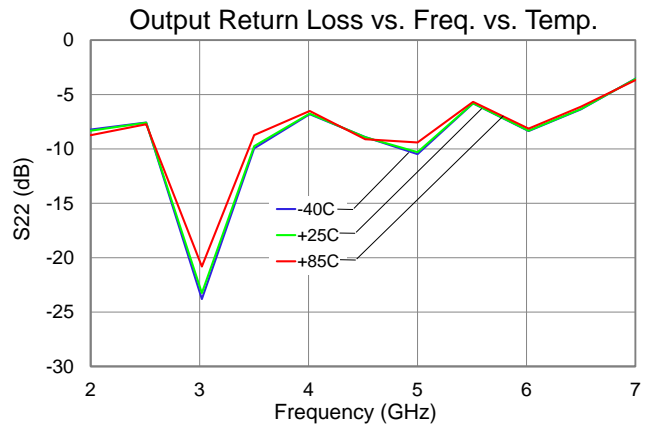
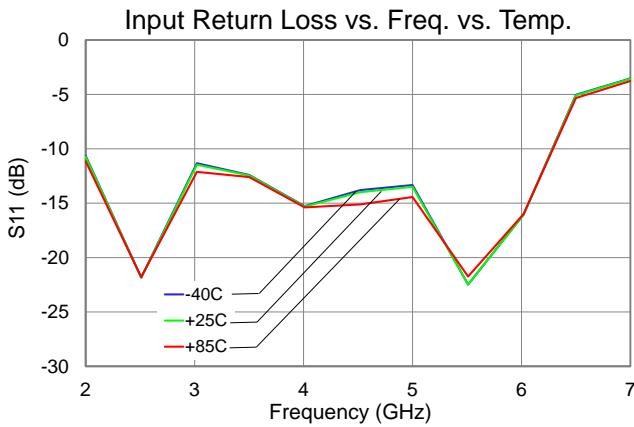
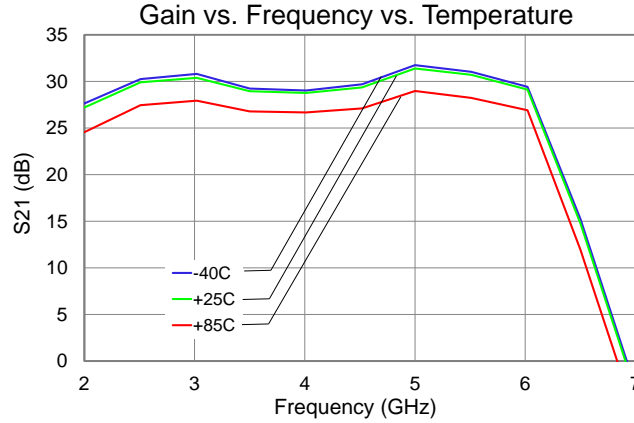

### Typical Performance (con't.)

Conditions unless otherwise specified:  $V_D = 30V$ ,  $I_{DQ} = 1.55A$ ,  $V_G = -2.5V$  Typical, CW

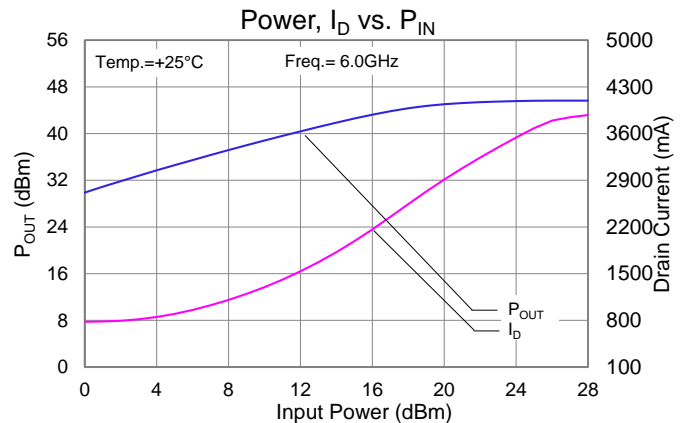
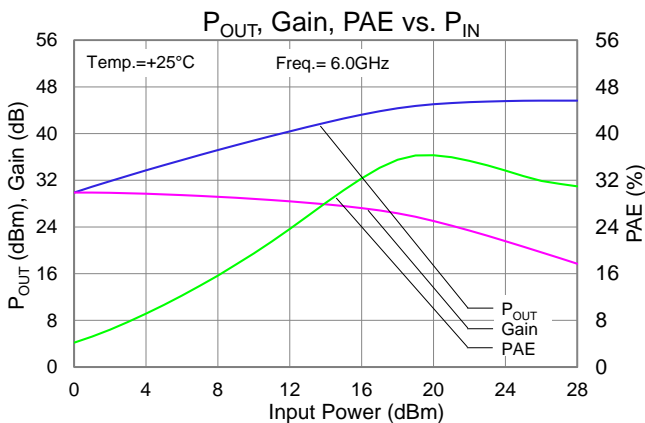
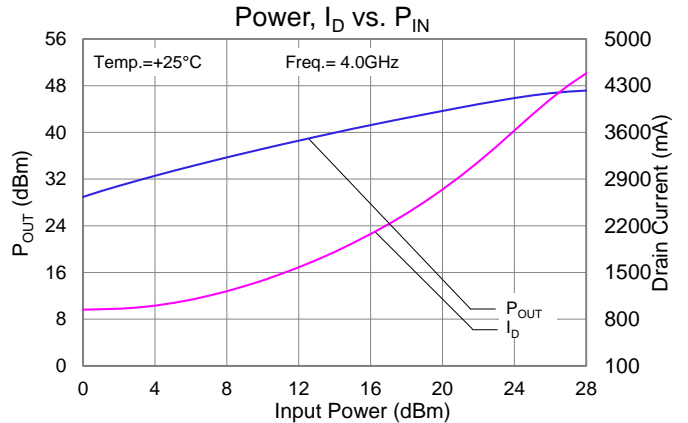
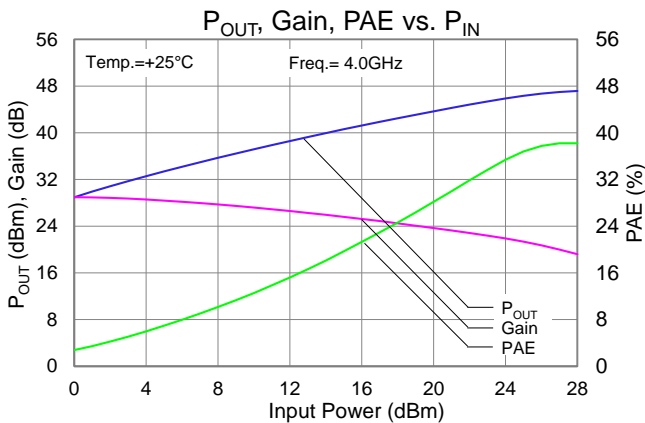
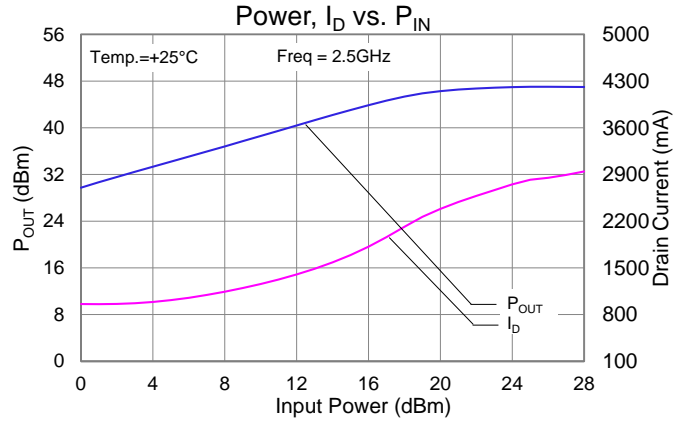
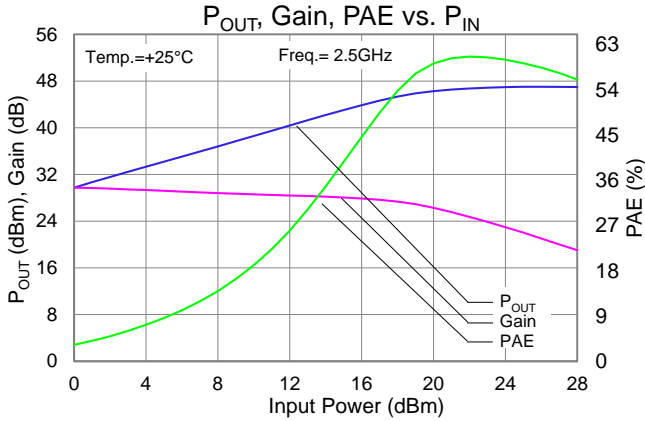

### Typical Performance (con't.)

Conditions unless otherwise specified:  $V_D = 30V$ ,  $I_{DQ} = 1.55A$ ,  $V_G = -2.5V$  Typical, CW

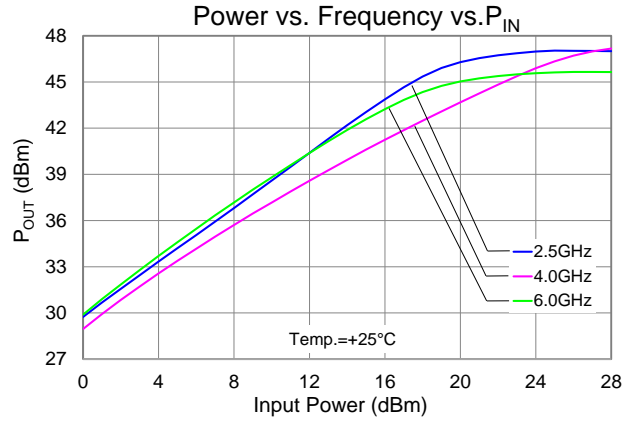
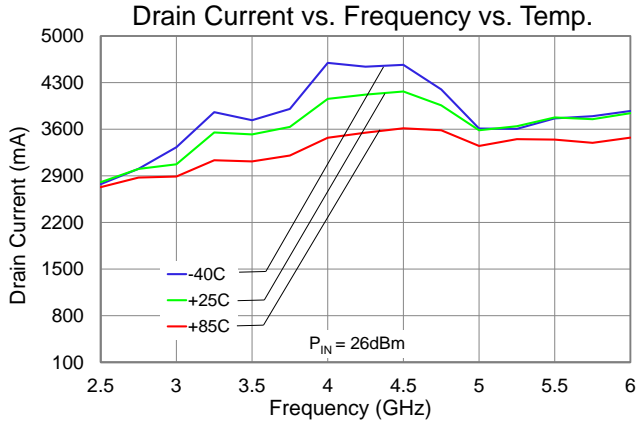

## Application Circuit

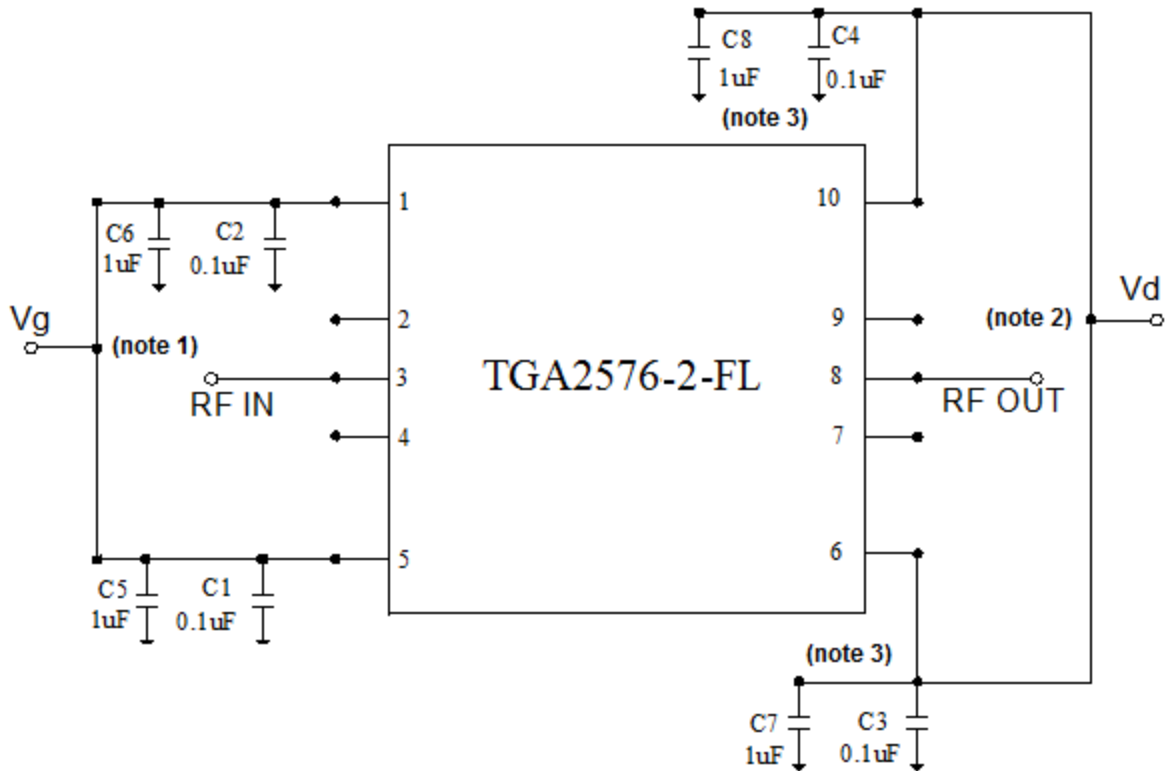

### Notes:

1.  $V_G$  must be biased from both sides (Pins 1 and 5).
2.  $V_D$  must be biased from both sides (Pins 6 and 10).
3. Remove caps for pulsed drain operation.

### Bias-up Procedure

1. Set  $I_D$  to 4.5A,  $I_G$  to 20mA
2.  $V_G$  set to -5.0V.
3.  $V_D$  set to +30V.
4. Adjust  $V_G$  until  $I_{DQ} \sim 1550$  mA ( $V_G \sim -2.5$ V Typical)
5. Turn on RF supply.

### Bias-down Procedure

1. Turn off RF signal.
2. Reduce  $V_G$  to -5.0V. Ensure  $I_{DQ} \sim 0$  mA.
3. Set  $V_D$  to 0V.
4. Set  $V_G$  to 0V.

**Pin Description**

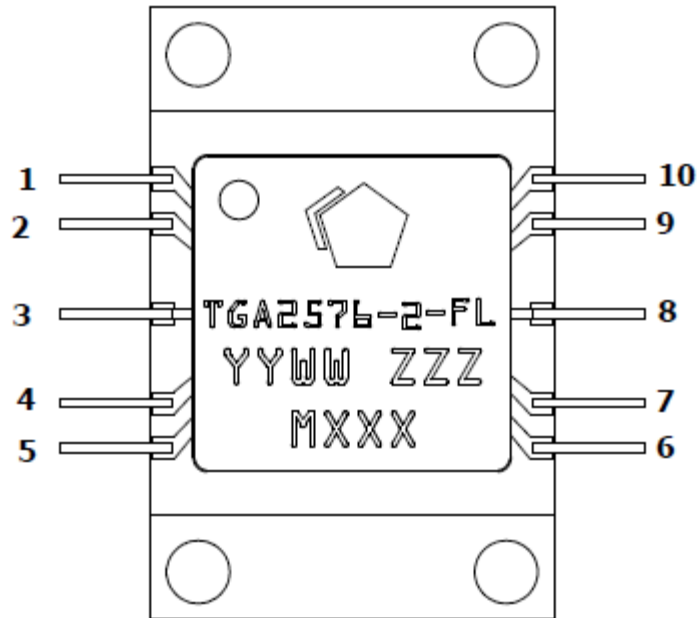

Pin	Symbol	Description
1, 5	$V_G$	Gate voltage. <sup>(1)</sup>
2, 4, 7, 9	N/C	No internal connection; may be grounded or left open on PCB.
3	RF IN	Input; matched to 50 $\Omega$ ; DC blocked
6, 10	$V_D$	Bottom side Drain voltage. <sup>(2)</sup>
8	RF OUT	Output; matched to 50 $\Omega$ .; DC blocked.
	(Package Base)	RF and DC ground.

Notes:

1. Bias network is required; must be biased from both sides (Pins 1 and 5); see Application Circuit on page 7 as an example.
2. Bias network is required; must be biased from both sides (Pins 6 and 10); see Application Circuit on page 7 as an example.



**Evaluation Board Layout**

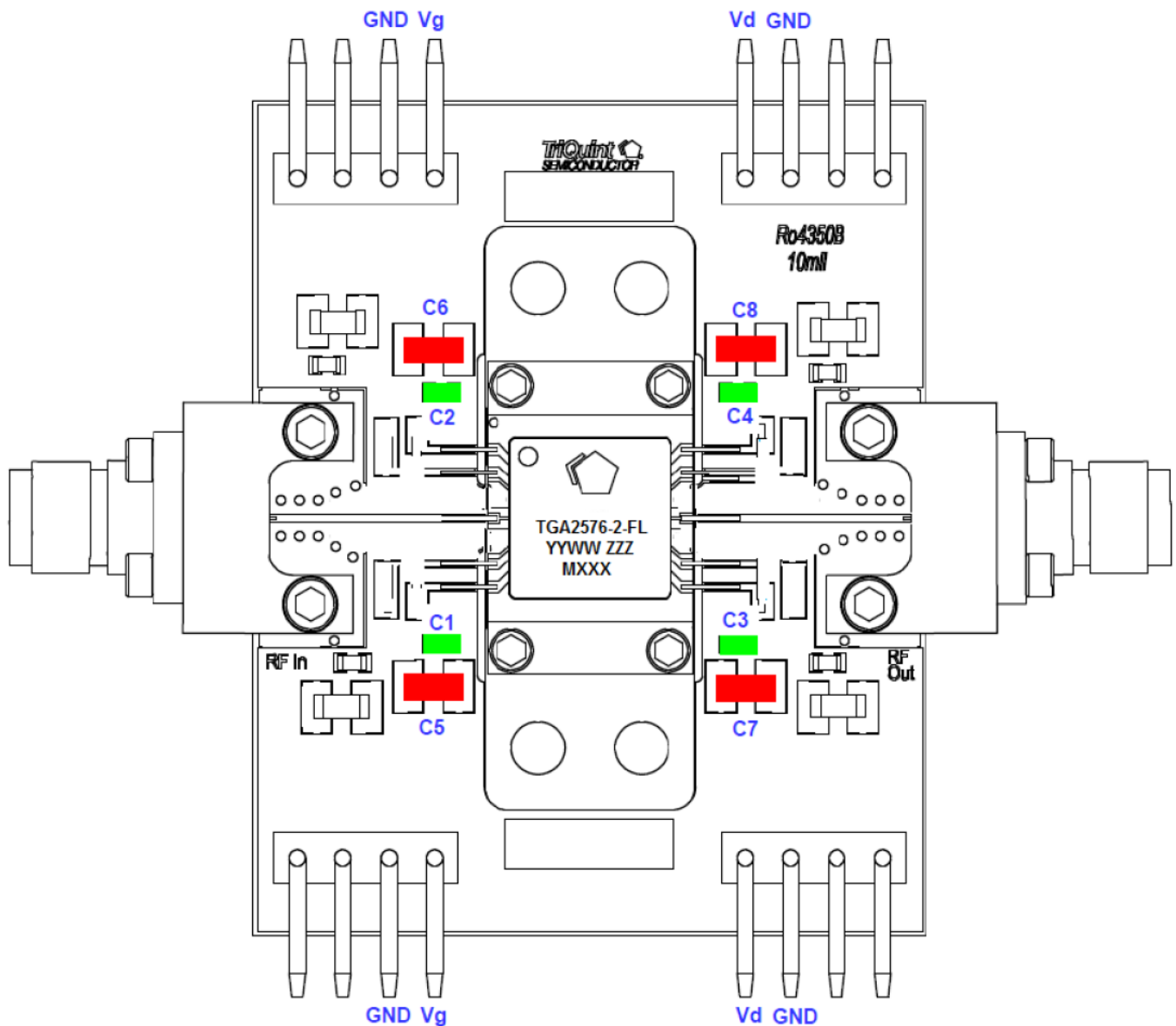

**Bill of Material**

Reference Des.	Value	Description	Manuf.	Part Number
C1 – C4	0.1 $\mu$ F	Cap, 0603, 50 V, 10%, X7R	Various	
C5 – C8	1 $\mu$ F	Cap, 1206, 50 V, 10%, X7R	Various	

### Mechanical Information – Package Information and Dimensions

Marking: Part number – TGA2576-2-FL  
 Year/week/lot code - YYWW ZZZ  
 Batch ID – MXXX

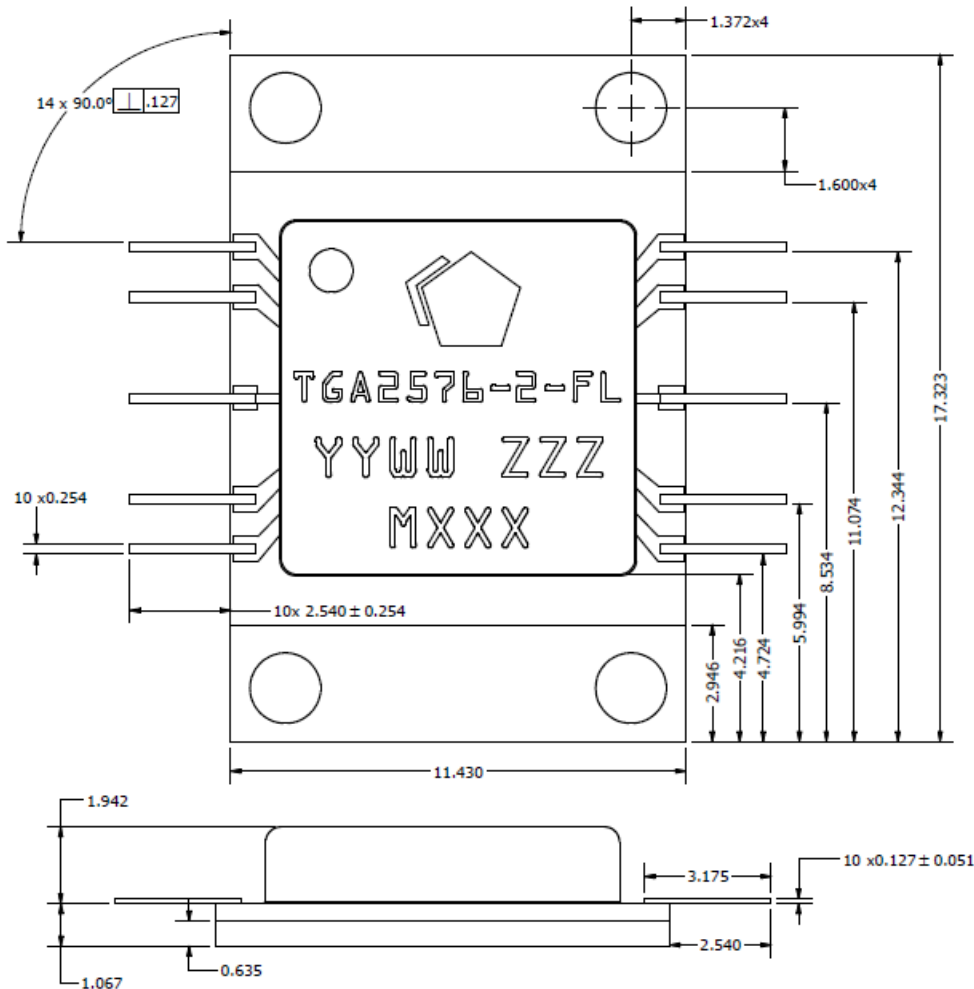

#### Notes:

1. Unless specified otherwise, dimensions are in millimeters (mm).
2. Unless specified otherwise, tolerances are  $\pm 0.127$
3. Materials:
  - Package base: Copper Tungsten (CuW) composite
  - Package lid: LCD (liquid crystal polymer)
  - Package leads: Kovar, MIL I 23011C Class 1
  - Plating finish: Gold (Au) 1.27 $\mu$ m minimum over Nickel (Ni) 2.54 to 8.89 $\mu$ m

### Assembly Notes

1. 0-80 screws are recommended for mounting the TGA2576-2-FL to the board.
2. To improve the thermal and RF performance, we recommend the following:
  - a) Apply thermal compound or 4 mils indium shim between the package and the board.
  - b) Attach a heat sink to the bottom of the board and apply thermal compound or 4 mils indium shim between the heat sink and the board.
3. Apply solder to each pin of the TGA2576-2-FL.

## Product Compliance Information

### ESD Sensitivity Ratings



Caution! ESD-Sensitive Device

ESD Rating: Class 1B  
Value:  $\geq 500V$  and  $< 1000V$   
Test: Human Body Model (HBM)  
Standard: JEDEC Standard JESD22-A114

### MSL Rating

Level 3 at +260 °C convection reflow  
The part is rated Moisture Sensitivity Level 3 at 260°C per  
JEDEC standard IPC/JEDEC J-STD-020.

### ECCN

US Department of Commerce: 3A001.b.2.a

### Solderability

This product also has the following attributes:

- Lead Free
- Halogen Free (Chlorine, Bromine)
- Antimony Free
- TBBP-A (C<sub>15</sub>H<sub>12</sub>Br<sub>4</sub>O<sub>2</sub>) Free
- PFOS Free
- SVHC Free

## Contact Information

For the latest specifications, additional product information, worldwide sales and distribution locations, and information about TriQuint:

Web: [www.triquint.com](http://www.triquint.com)

Tel: +1.972.994.8465

Email: [info-sales@triquint.com](mailto:info-sales@triquint.com)

Fax: +1.972.994.8504

For technical questions and application information: Email: [info-products@triquint.com](mailto:info-products@triquint.com)

## Important Notice

The information contained herein is believed to be reliable. TriQuint makes no warranties regarding the information contained herein. TriQuint assumes no responsibility or liability whatsoever for any of the information contained herein. TriQuint assumes no responsibility or liability whatsoever for the use of the information contained herein. The information contained herein is provided "AS IS, WHERE IS" and with all faults, and the entire risk associated with such information is entirely with the user. All information contained herein is subject to change without notice. Customers should obtain and verify the latest relevant information before placing orders for TriQuint products. The information contained herein or any use of such information does not grant, explicitly or implicitly, to any party any patent rights, licenses, or any other intellectual property rights, whether with regard to such information itself or anything described by such information.

TriQuint products are not warranted or authorized for use as critical components in medical, life-saving, or life-sustaining applications, or other applications where a failure would reasonably be expected to cause severe personal injury or death.

# Mouser Electronics

Authorized Distributor

Click to View Pricing, Inventory, Delivery & Lifecycle Information:

[TriQuint:](#)

[TGA2576-2-FL](#)