

Product Description

Qorvo's TGA2214-CP is a packaged wideband power amplifier fabricated on Qorvo's QGaN15 0.15 μm GaN on SiC process. Operating from 2 to 18 GHz, the TGA2214-CP generates > 4 W saturated output power with a power-added efficiency of > 15%, and > 14 dB large signal gain across the entire operational band.

The TGA2214-CP is offered in a 10-lead 15 x 15 mm bolt-down package. The package has a pure Cu base, offering superior thermal management. The TGA2214-CP is ideally suited to support, both in the commercial and the defense arenas, applications requiring either wideband or multi-band frequency performance.

Both RF ports have integrated DC blocking capacitors and are fully matched to 50 Ohms.

Lead free and RoHS compliant.

Evaluation Boards are available upon request.

Functional Block Diagram

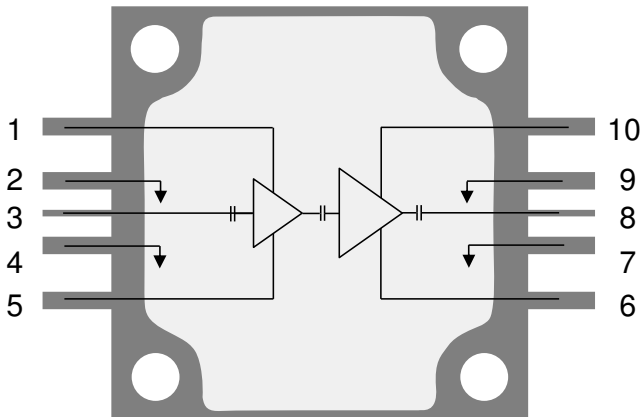

Product Features

- Frequency Range: 2 – 18 GHz
- P_{OUT} : > 36 dBm at $P_{IN} = 23$ dBm
- PAE: > 15% CW at $P_{IN} = 23$ dBm
- Small Signal Gain: > 22 dB
- IM3: < -17 dBc at 30 dBm P_{OUT} /Tone
- Bias: $V_D = +22$ V, $I_{DQ} = 600$ mA, $V_G = -2.3$ V Typical
- Package Dimensions: 15.2 x 15.2 x 3.5 mm
- Package base is pure Cu offering superior thermal management

Applications

- Test Equipment
- Electronic Warfare
- Military and Commercial Radar

Ordering Information

Part No.	ECCN	Description
TGA2214-CP	3A001.b.2.c	2 – 18 GHz 4 W GaN Power Amplifier

Absolute Maximum Ratings

Parameter	Value / Range
Drain Voltage (V_D)	+29.5 V
Gate Voltage Range (V_G)	-5 to 0 V
Drain Current (I_D)	
1 st stage	0.5 A
2 nd stage	1.0 A
Forward Gate Current (I_G)	See graph this page
Power Dissipation (P_{DISS}), 85 °C	31 W
Input Power, CW, 50 Ω , (P_{IN})	31 dBm
Input Power, CW, VSWR 3:1, $V_D = +30$ V, 85 °C, (P_{IN})	31 dBm
Channel Temperature (T_{CH})	275 °C
Mounting Temperature (30 Seconds)	260 °C
Storage Temperature	-55 to 150 °C

Operation of this device outside the parameter ranges given above may cause permanent damage. These are stress ratings only, and functional operation of the device at these conditions is not implied.

Recommended Operating

Parameter	Value / Range
Drain Voltage (V_D)	+22 V
Drain Current (I_{DQ})	600 mA
Drain Current Under RF Drive (I_{D_DRIVE})	See plots p. 7
Gate Voltage (V_G)	-2.3 V (Typ.)
Gate Current Under RF Drive (I_{G_DRIVE})	See plots p. 7
Temperature (T_{BASE})	-40 to 85 °C

Electrical specifications are measured at specified test conditions. Specifications are not guaranteed over all recommended operating conditions.

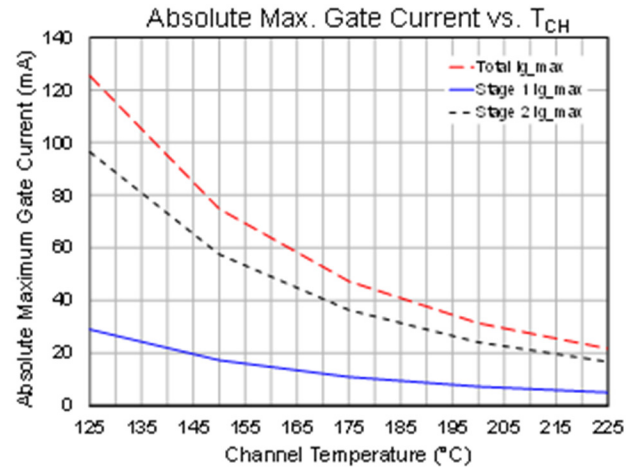

Electrical Specifications

Parameter	Min	Typ	Max	Units
Operational Frequency Range	2	-	18	GHz
Small Signal Gain	-	> 22	-	dB
Input Return Loss	-	> 8	-	dB
Output Return Loss	-	> 11	-	dB
Output Power at $P_{IN} = 23$ dBm	-	> 36	-	dBm
Power Added Efficiency at $P_{IN} = 23$ dBm	-	> 15	-	%
IM3 ($P_{OUT} / \text{Tone} = 30$ dBm/Tone)	-	< -17	-	dBc
IM5 ($P_{OUT} / \text{Tone} = 30$ dBm/Tone)	-	< -29	-	dBc
Small Signal Gain Temperature Coefficient	-	-0.04	-	dB/°C
Output Power Temperature Coefficient (25 to 85 °C)	-	-0.005	-	dBm/°C
Recommended Operating Voltage	-	+22	+22	V

Test conditions unless otherwise noted: 25 °C, $V_D = +22$ V, $I_{DQ} = 600$ mA, $V_G = -2.3$ V Typ, CW.

Thermal and Reliability Information

Parameter	Test Conditions	Value	Units
Thermal Resistance (θ_{JC}) ⁽¹⁾	$T_{BASE} = 85\text{ }^\circ\text{C}$, $V_D = +22\text{ V}$ (CW)	6.2	$^\circ\text{C/W}$
Channel Temperature (T_{CH}) (Under RF drive)	At Freq = 10 GHz, $P_{IN} = 23\text{ dBm}$: $I_{DQ} = 600\text{ mA}$, $I_{D_Drive} = 1.3\text{ A}$	232	$^\circ\text{C}$
Median Lifetime (T_M)	$P_{OUT} = 37\text{ dBm}$, $P_{DISS} = 23.6\text{ W}$	4.4E+6	Hrs

Notes:

1. Thermal resistance measured to back of package.

Median Lifetime

Test Conditions: $V_D = +28\text{ V}$; Failure Criteria = 10% reduction in ID_MAX

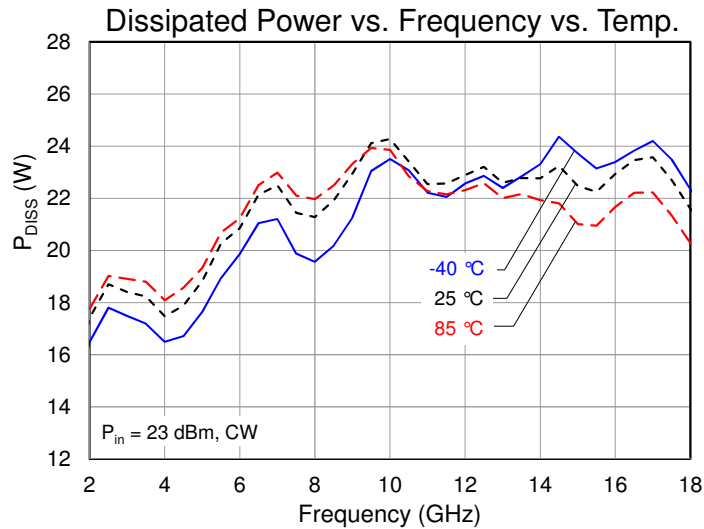
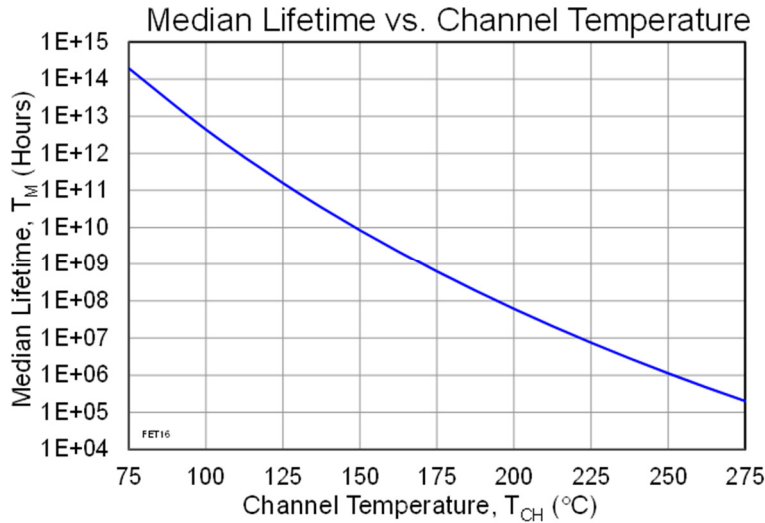

Performance Plots – Small Signal

Conditions unless otherwise specified: $V_D = +22\text{ V}$, $I_{DQ} = 600\text{ mA}$, $V_G = -2.3\text{ V}$ Typical, CW.

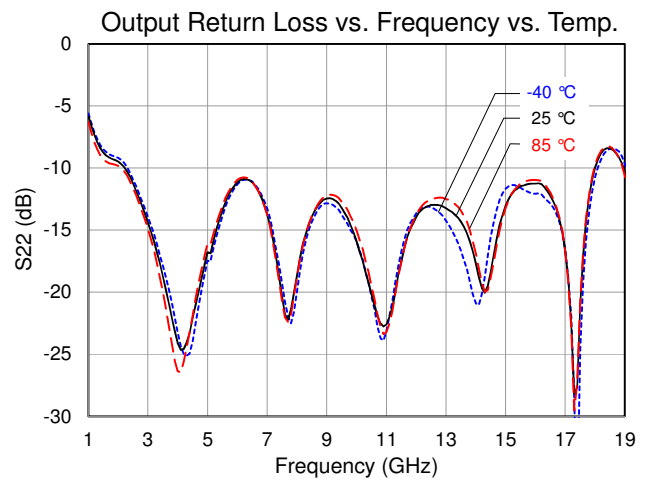
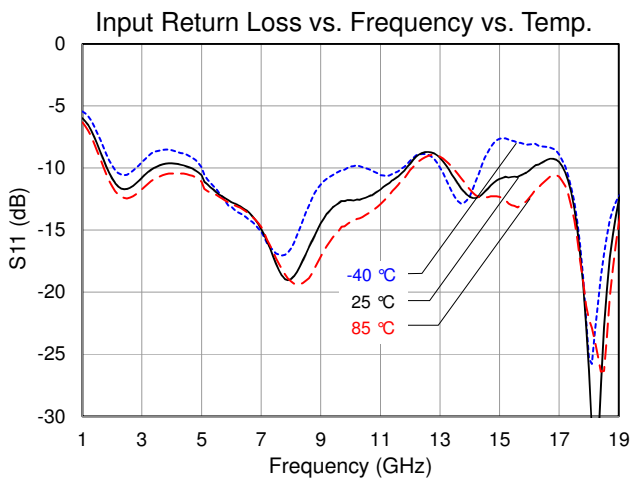
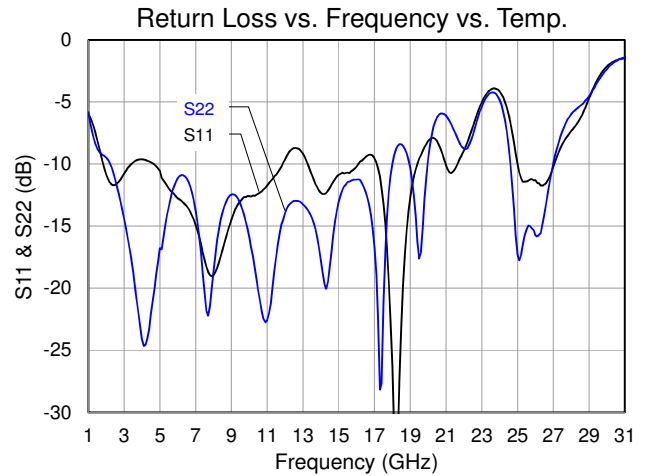
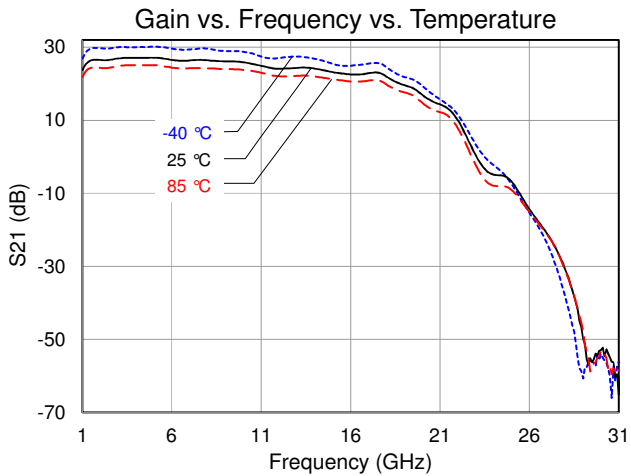
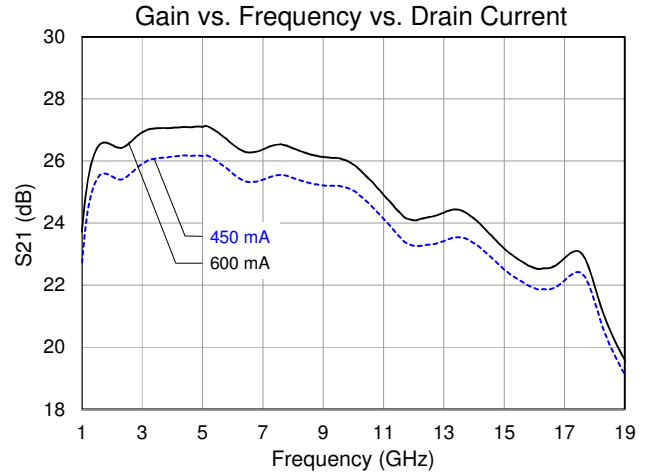
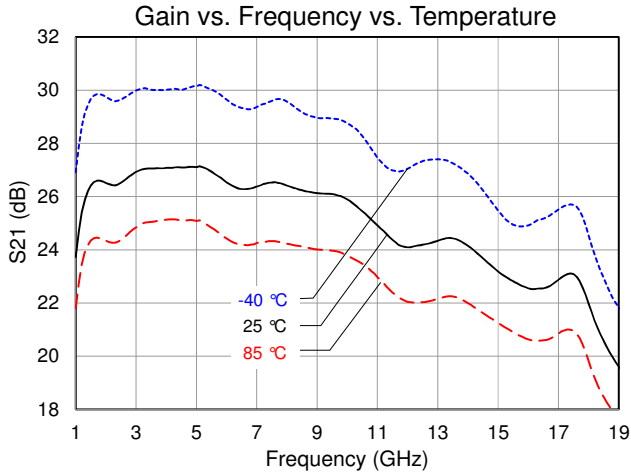

Performance Plots – Large Signal

Conditions unless otherwise specified: $V_D = +22\text{ V}$, $I_{DQ} = 600\text{ mA}$, $V_G = -2.3\text{ V}$ Typical, CW.

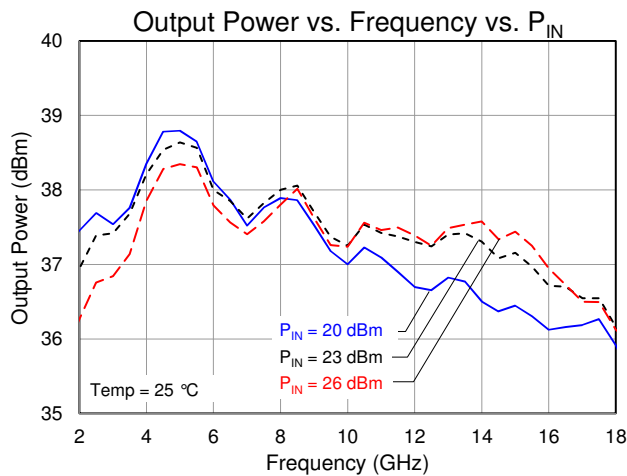
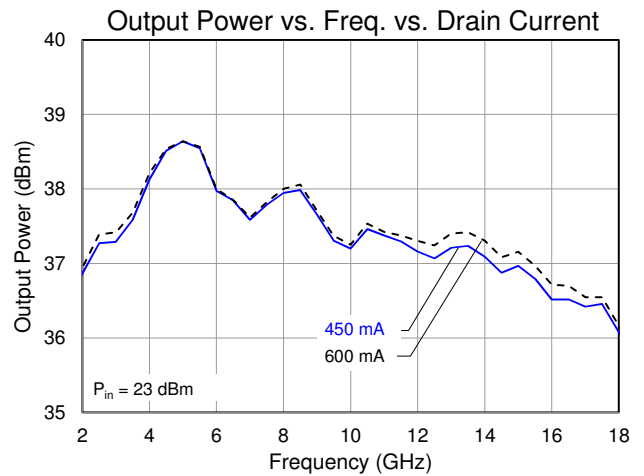
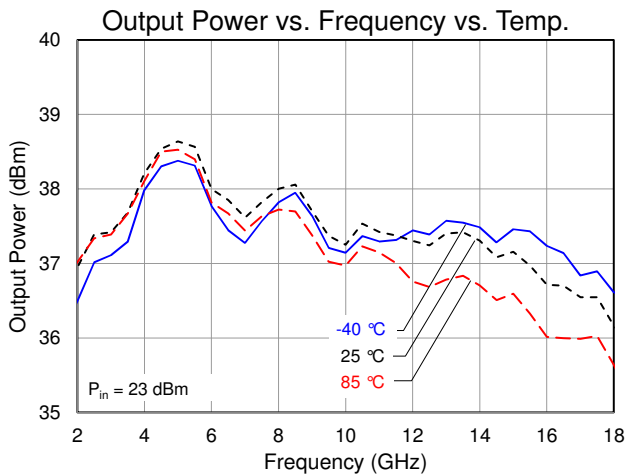
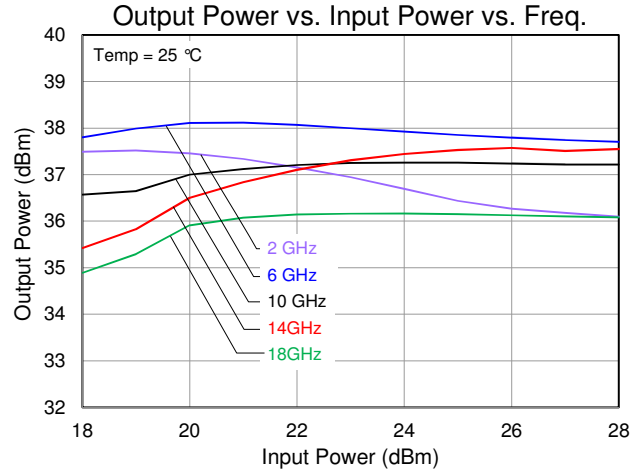
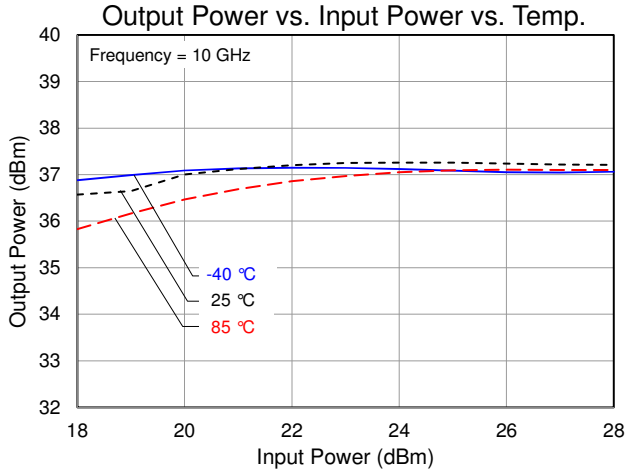

Performance Plots – Large Signal

Conditions unless otherwise specified: $V_D = +22\text{ V}$, $I_{DQ} = 600\text{ mA}$, $V_G = -2.3\text{ V}$ Typical, CW.

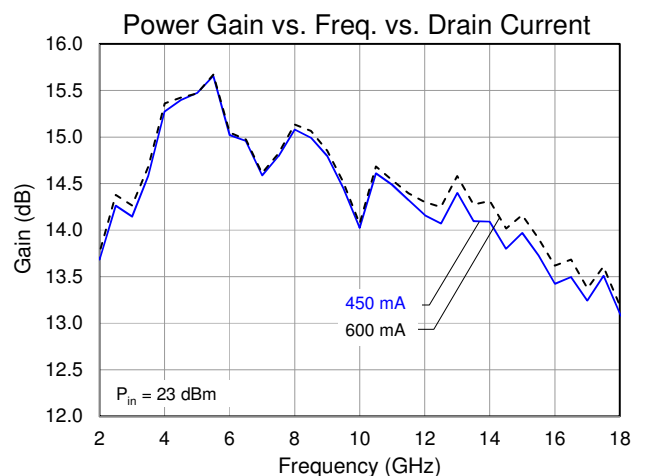
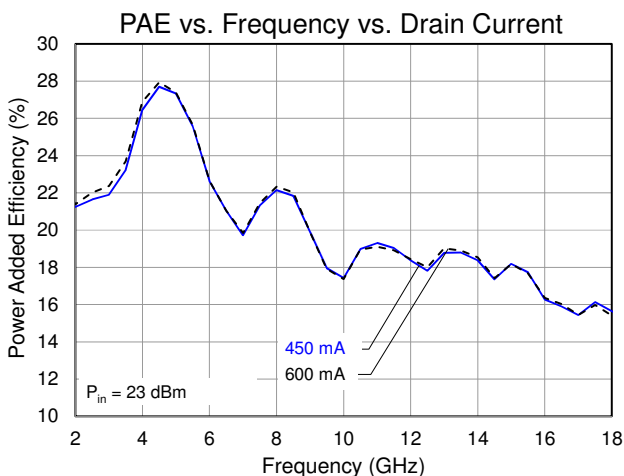
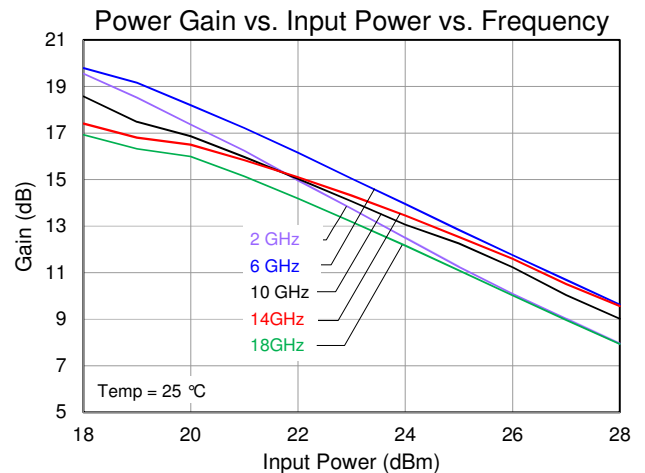
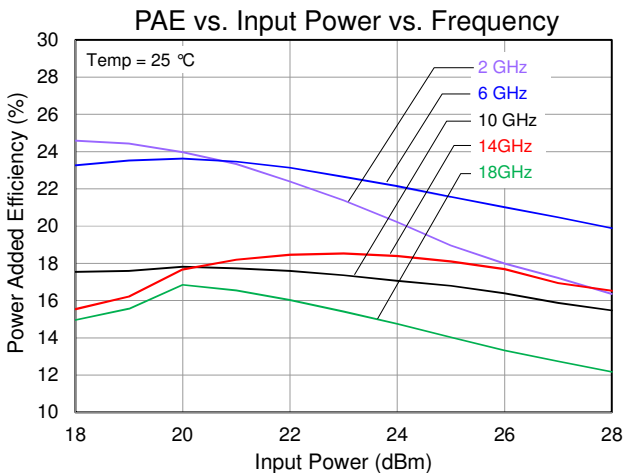
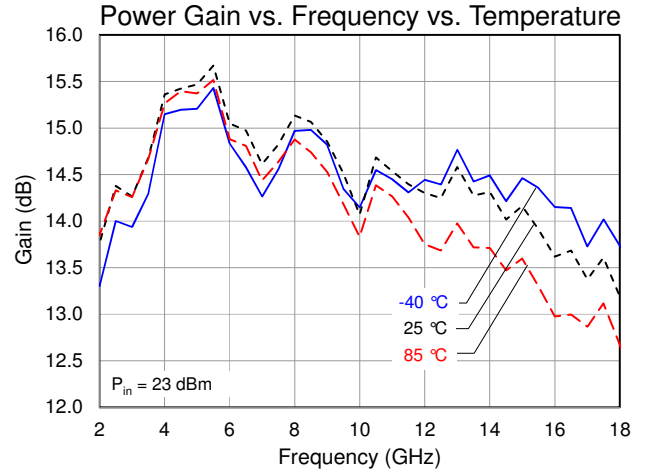
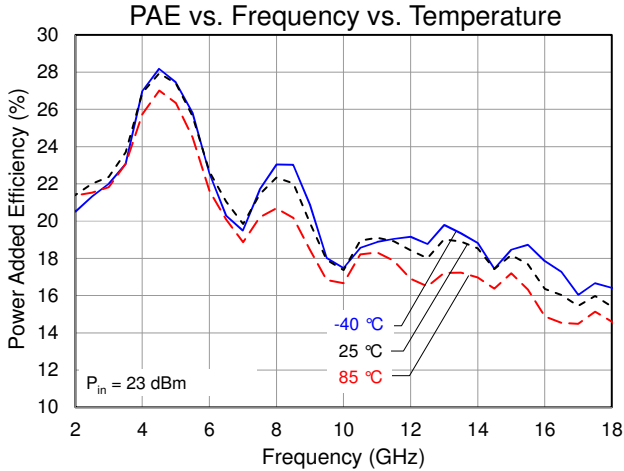

Performance Plots – Large Signal

Conditions unless otherwise specified: $V_D = +22\text{ V}$, $I_{DQ} = 600\text{ mA}$, $V_G = -2.3\text{ V}$ Typical, CW.

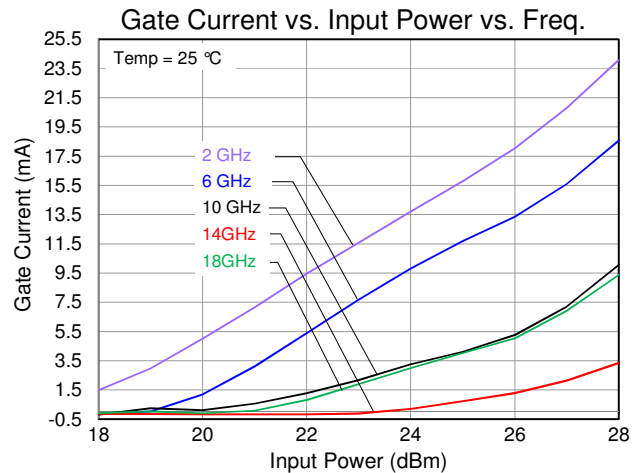
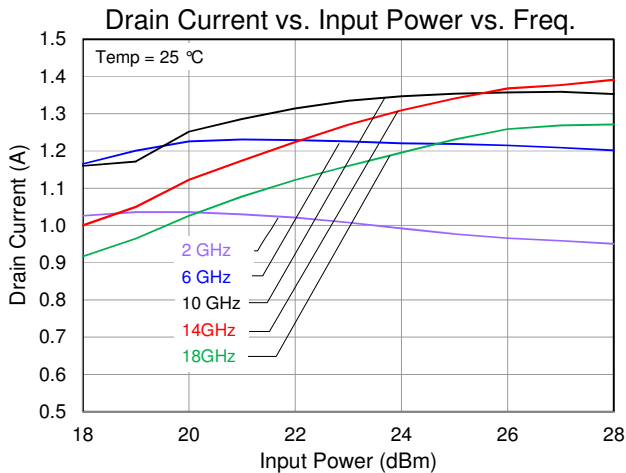
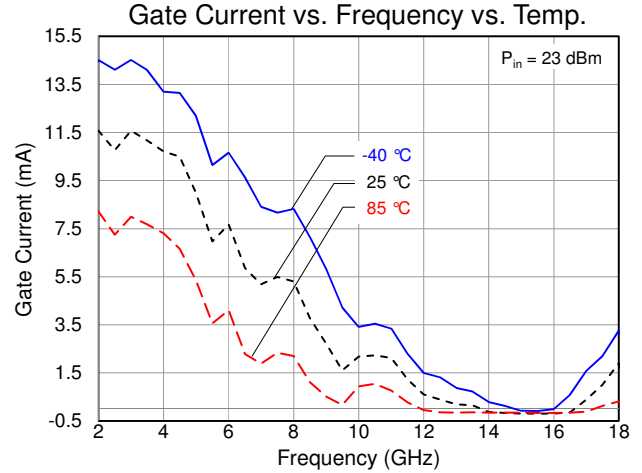
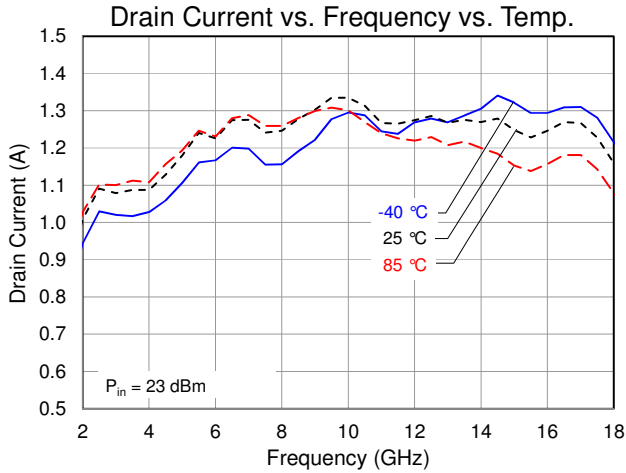

Performance Plots – Linearity

Conditions unless otherwise specified: $V_D = +22\text{ V}$, $I_{DQ} = 600\text{ mA}$, $V_G = -2.3\text{ V}$ Typical, CW.

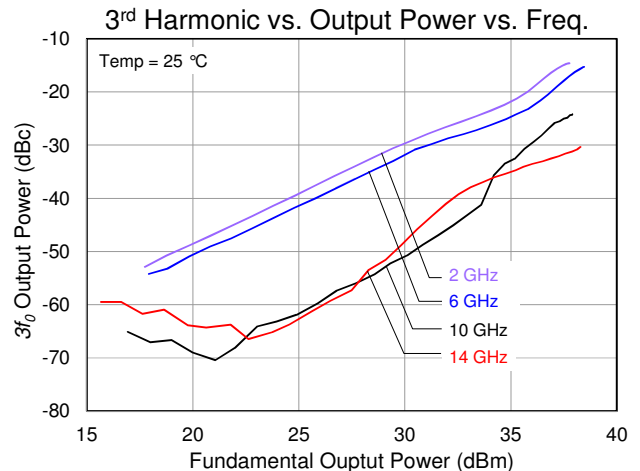
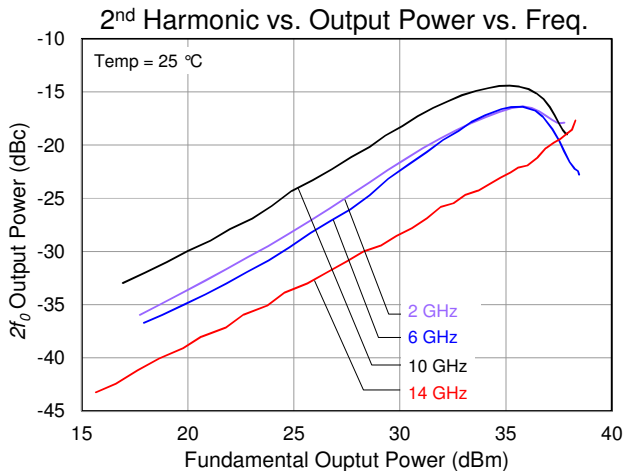
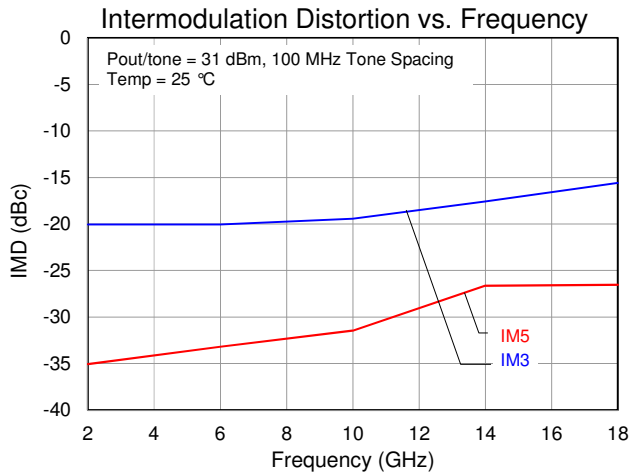
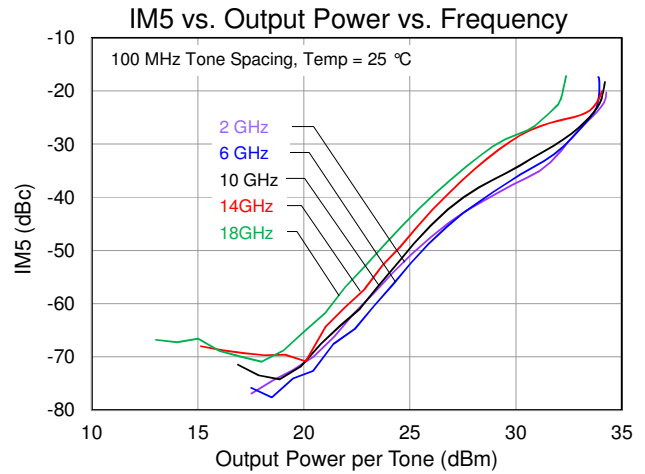
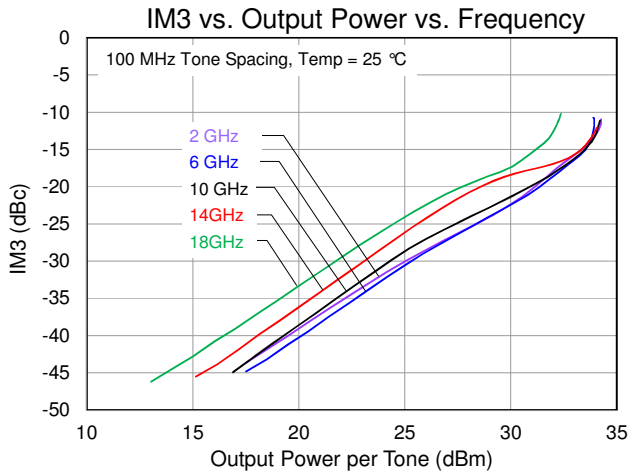

Applications Information and Pin Layout

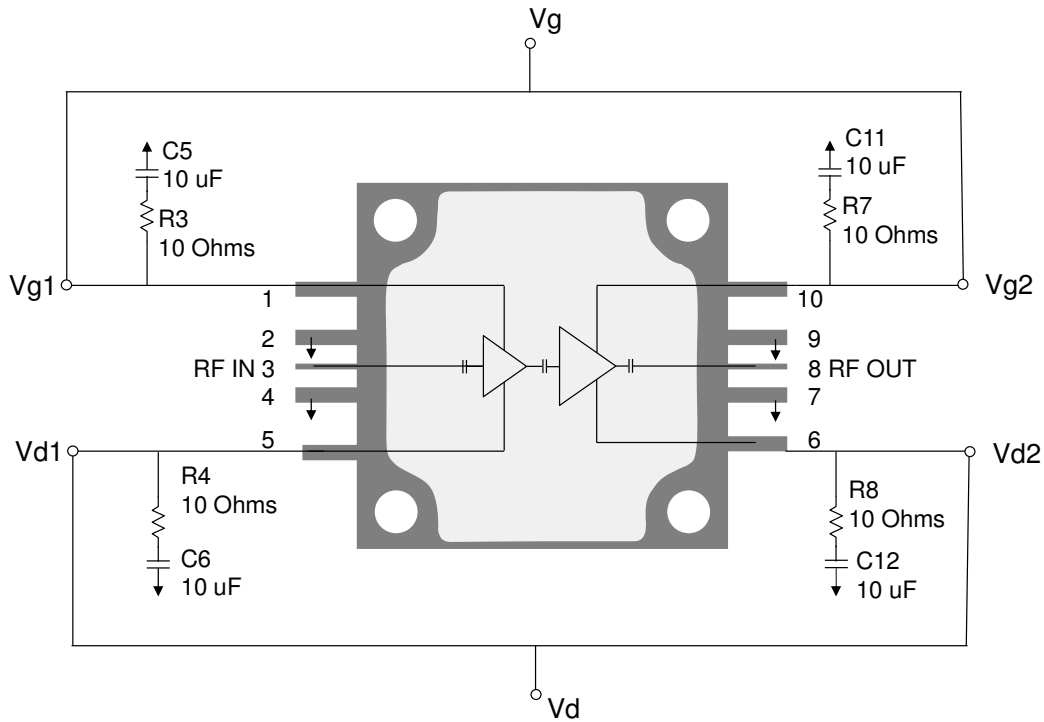

Bias Up Procedure

1. Set I_D limit to 1.5 A, I_G limit to 26 mA
2. Apply -5 V to V_G
3. Apply $+22\text{ V}$ to V_D ; ensure I_{DQ} is approx. 0 mA
4. Adjust V_G until $I_{DQ} = 600\text{ mA}$ ($V_G \sim -2.3\text{ V Typ.}$).
5. Turn on RF supply

Bias Down Procedure

1. Turn off RF supply
2. Reduce V_G to -5 V ; ensure I_{DQ} is approx. 0 mA
3. Set V_D to 0 V
4. Turn off V_D supply
5. Turn off V_G supply

Pad Description

Pin No.	Symbol	Description
1,10	V_{G1}, V_{G2} (respectively)	Gate Voltage; Bias network is required; must be biased from both sides; see recommended Application Information above.
3	RF_{IN}	Output; matched to $50\ \Omega$; DC blocked
2,4,7,9	GND	Must be grounded on the PCB.
5,6	V_{D1}, V_{D2} (respectively)	Drain voltage; Bias network is required; must be biased from both sides; see recommended Application Information above.
8	RF_{OUT}	Input; matched to $50\ \Omega$; DC blocked

Evaluation Board

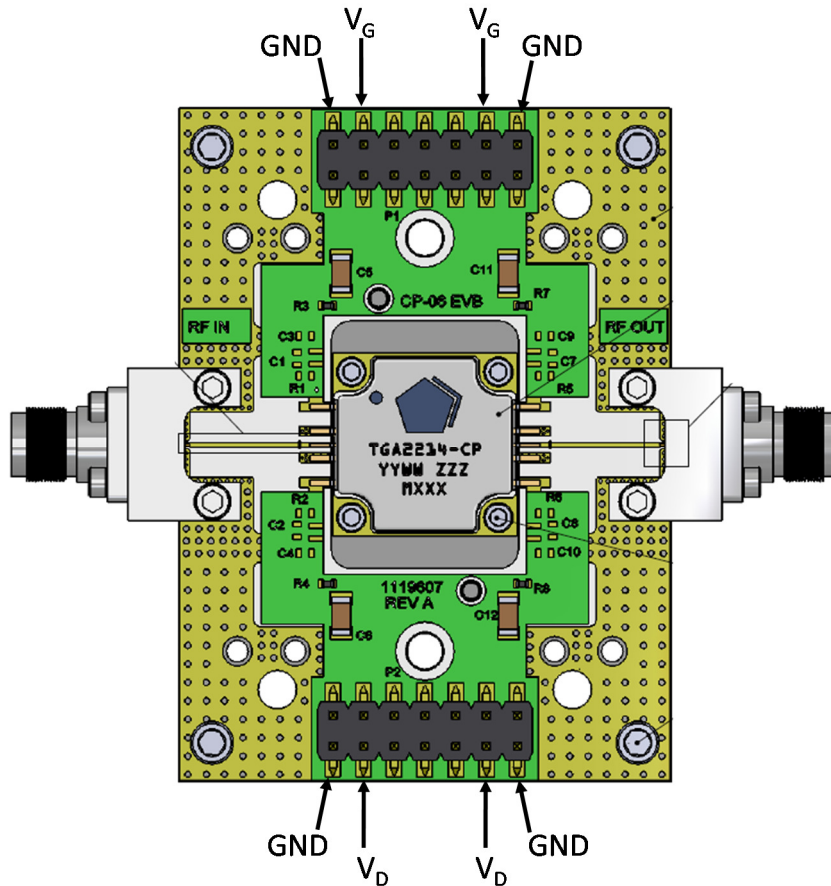

Notes:

1. Both V_D and V_G pins must be biased.

Bill of Materials

Reference Des.	Value	Description	Manuf.	Part Number
C5, C6, C11, C12	10 μ F	Cap, 1206, +50 V, 20 %, X5R	Various	–
R3, R4, R7, R8	10 Ohm	Res, 0402, 5 %	Various	–

Assembly Notes

1. Clean the board or module with alcohol. Allow it to dry fully.
2. Nylock screws are recommended for mounting the TGA2214-CP to the board.
3. To improve the thermal and RF performance, we recommend the following:
 - a. Apply thermal compound or 4 mils indium shim between the package and the board.
 - b. Attach a heat sink to the bottom of the board and apply thermal compound or 4 mils indium shim between the heat sink and the board.
4. Apply solder to each pin of the TGA2214-CP.
5. Clean the assembly with alcohol.

Mechanical Information

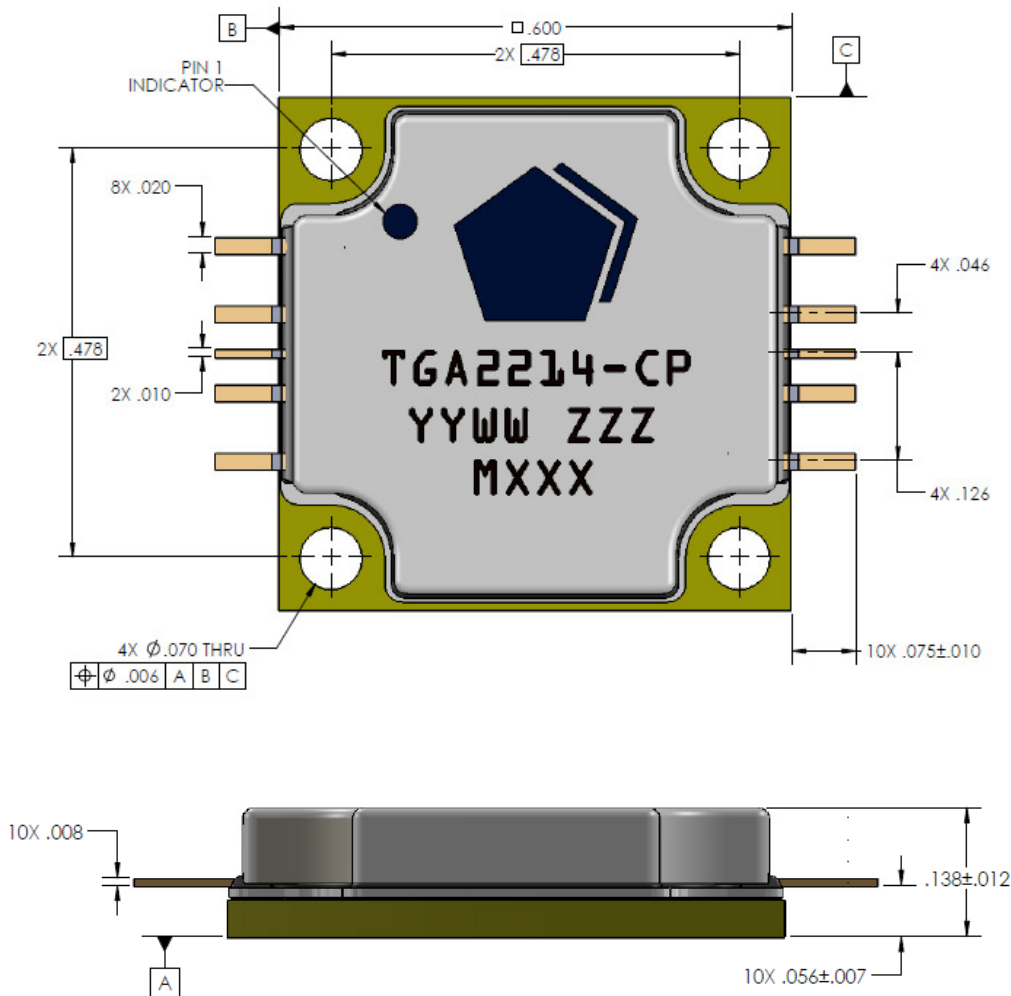

Units: inches

Tolerances: unless specified

x.xx = ± 0.01

x.xxx = ± 0.005

Materials:

Base: Copper

Lid: Plastic

All metalized features are gold plated

Part is epoxy sealed

Marking:

2214: Part number

YY: Part Assembly year

WW: Part Assembly week

ZZZ: Serial Number

MXXX: Batch ID

Handling Precautions

Parameter	Rating	Standard
ESD – Human Body Model (HBM)	Class 1B	JEDEC Standard JESD22 A114
MSL – 260 °C Convection Reflow	Level 5A	JEDEC standard IPC/JEDEC J-STD-020.



Caution!
 ESD-Sensitive Device

Solderability

Compatible with the latest version of J-STD-020, Lead-free solder, 260 °C

RoHS Compliance

This product is compliant with the 2011/65/EU RoHS directive (Restrictions on the Use of Certain Hazardous Substances in Electrical and Electronic Equipment), as amended by Directive 2015/863/EU. This product also has the following attributes:

- Lead Free
- Halogen Free (Chlorine, Bromine)
- Antimony Free
- TBBP-A (C₁₅H₁₂Br₄O₂) Free
- PFOS Free
- SVHC Free

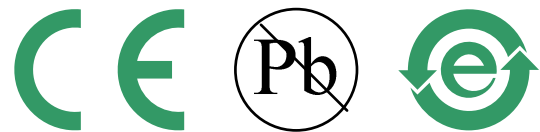

Contact Information

For the latest specifications, additional product information, worldwide sales and distribution locations, and information about Qorvo:

Web: www.qorvo.com **Tel:** +1.972.994.8465
Email: info-sales@qorvo.com **Fax:** +1.972.994.8504

For technical questions and application information:

Email: info-products@qorvo.com

Important Notice

The information contained herein is believed to be reliable. Qorvo makes no warranties regarding the information contained herein. Qorvo assumes no responsibility or liability whatsoever for any of the information contained herein. Qorvo assumes no responsibility or liability whatsoever for the use of the information contained herein. The information contained herein is provided "AS IS, WHERE IS" and with all faults, and the entire risk associated with such information is entirely with the user. All information contained herein is subject to change without notice. Customers should obtain and verify the latest relevant information before placing orders for Qorvo products. The information contained herein or any use of such information does not grant, explicitly or implicitly, to any party any patent rights, licenses, or any other intellectual property rights, whether with regard to such information itself or anything described by such information.

Qorvo products are not warranted or authorized for use as critical components in medical, life-saving, or life-sustaining applications, or other applications where a failure would reasonably be expected to cause severe personal injury or death.

Mouser Electronics

Authorized Distributor

Click to View Pricing, Inventory, Delivery & Lifecycle Information:

Qorvo:

[TGA2214-CP Eval Board](#) [TGA2214-CP](#)