

**Towers, Faucets, Handles, Medallions, Shanks, Drip Trays, Chillers, Glycol, Trunk Lines and Tubing, Line Labels, Tools, Installation Simplifiers, Visual Dispensers, Bar Guns, Ice Chests, Conversion and Leg Stands, Cold Plates, Couplers/Taps, Picnic Pumps, Picnic Coolers, Special Events, Branded Displays, Keggerators, Fridge Kits, Keg Accessories, FOB Stops, Gas and Electric Pumps, CO<sub>2</sub> Tanks & Detector/Alarm, Regulators, Compressors, Gas Blenders, Fittings, Cleaners, Under Bar, Cocktail Stations, Glasswashers, Mug Frosters, Back Bar Refrigeration, Back Bar Storage, Glass Display Units, Bar Accessories, Installer Checklist**

## Remote Beer System, Part A Back Room Components

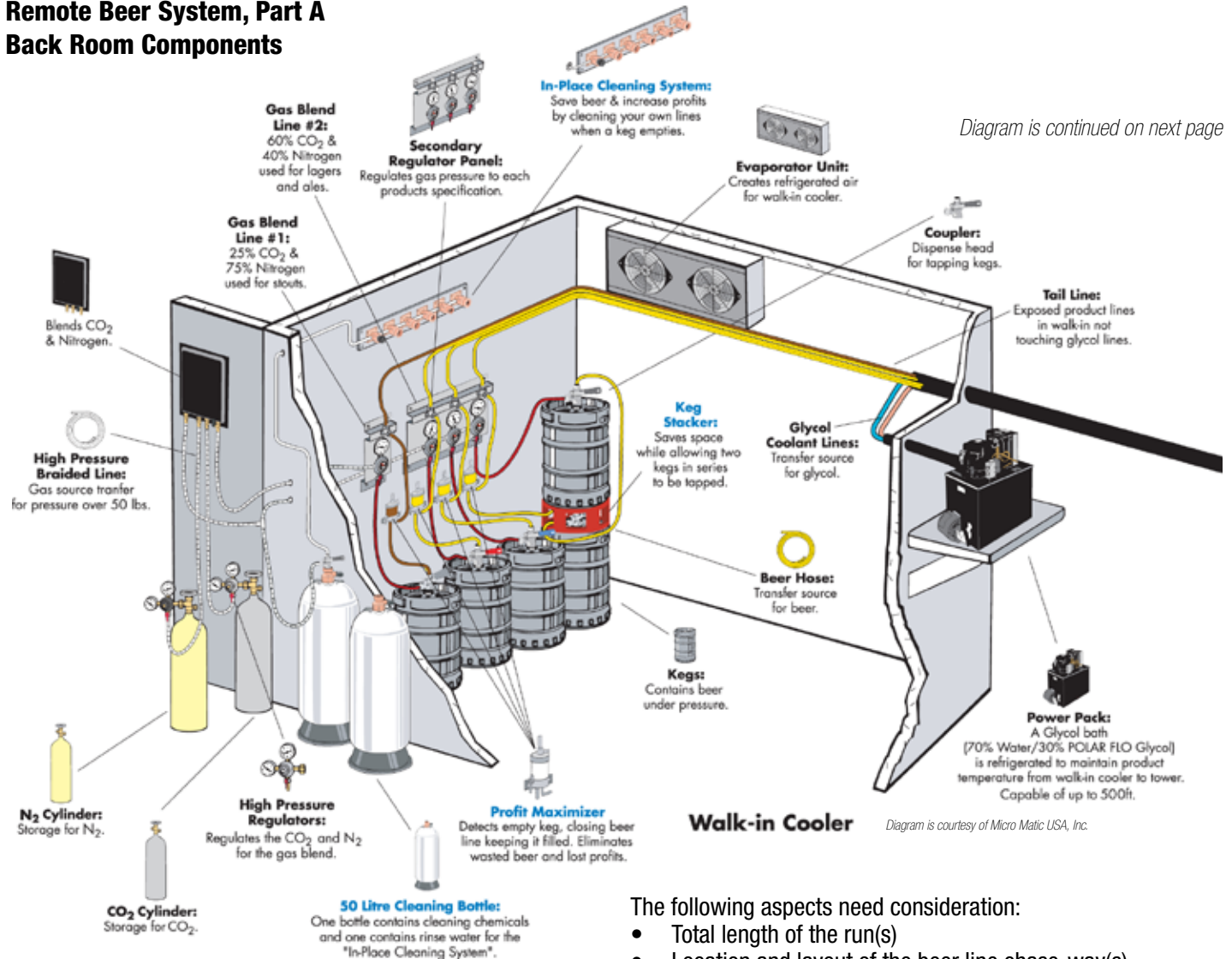

Diagram is courtesy of Micro Matic USA, Inc.

To design your remote draft beer system, knowledge of your basic requirements is necessary. Our sales people are eager to discuss the various options to fit your needs and budget. Please feel free to contact us with any questions.

The following aspects need consideration:

- Total length of the run(s)
- Location and layout of the beer line chase-way(s)
- Net vertical lift or drop (distance from bottom of keg to beer faucet)
- Number of dispensing stations, the type of beer tower(s), and the number of faucets on each tower
- Number of kegs to be stored in the walk-in cooler
- Line chiller location and if a line chiller leg set, stand or wall rack is required
- Method of counter pressure: beer pumps or blended N<sub>2</sub>/CO<sub>2</sub>
- Type of primary CO<sub>2</sub> storage: tank or bulk
- If keg taps are required or supplied by others

## Remote Beer System, Part B

An installer checklist can be found on the last four pages of this section to help build a complete beer dispensing system.

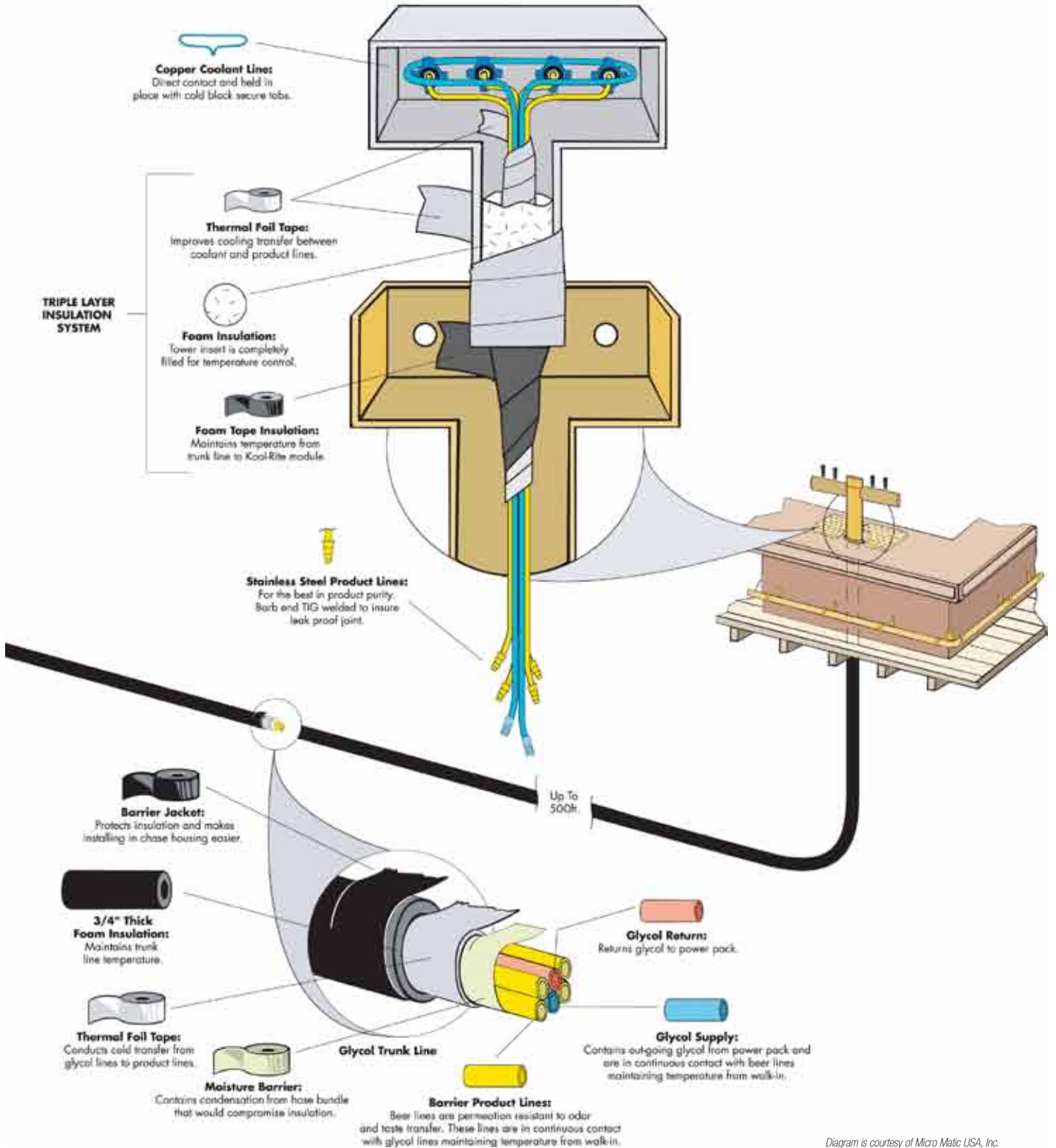
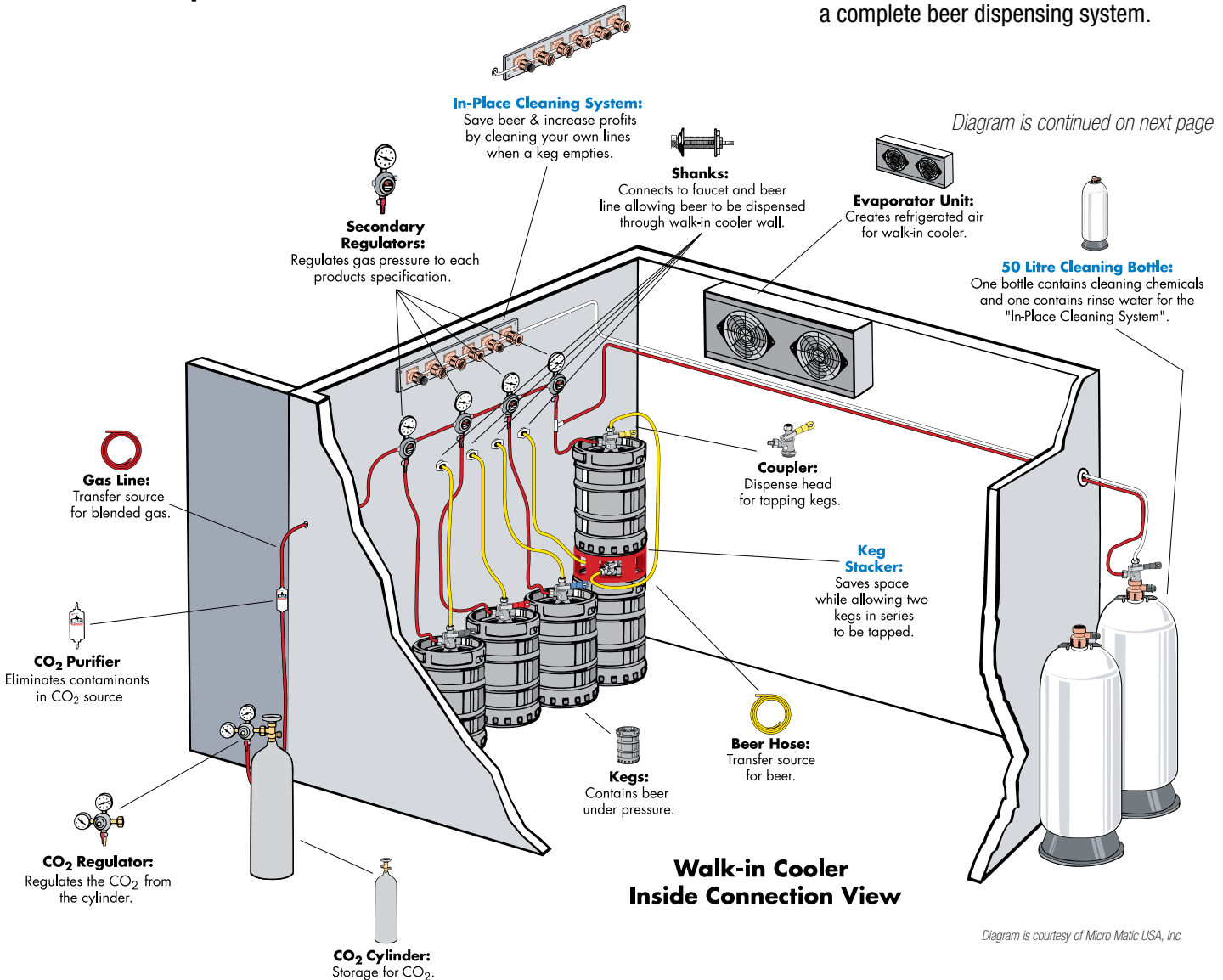

Diagram is courtesy of Micro Matic USA, Inc.

## Wall Mounted Direct Draw System, Part A Back Room Components

An installer checklist can be found on the last four pages of this section to help build a complete beer dispensing system.



To design your remote draft beer system, knowledge of your basic requirements is necessary. Our sales people are eager to discuss the various options to fit your needs and budget. Please feel free to contact us with any questions.

The following aspects need consideration:

- Total length of the run(s)
- Location and layout of the beer line chase-way(s)
- Net vertical lift or drop (distance from bottom of keg to beer faucet)
- Number of dispensing stations, the type of beer tower(s), and the number of faucets on each tower
- Number of kegs to be stored in the walk-in cooler
- Line chiller location and if a line chiller leg set, stand or wall rack is required
- Method of counter pressure: beer pumps or blended N<sub>2</sub>/CO<sub>2</sub>
- Type of primary CO<sub>2</sub> storage: tank or bulk
- If keg taps are required or supplied by others

## Wall Mounted Direct Draw System, Part B

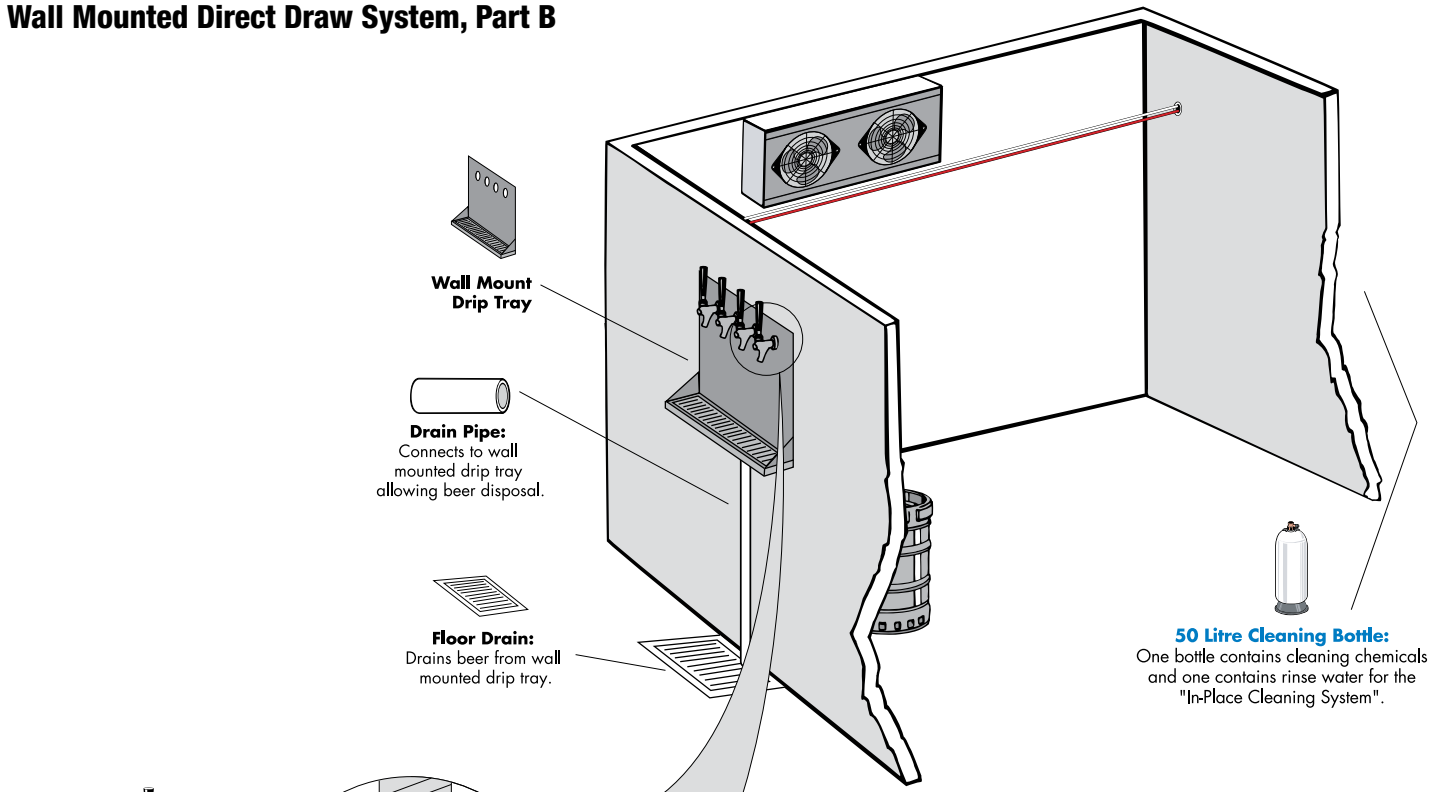

**Walk-in Cooler  
Outside Connection View**

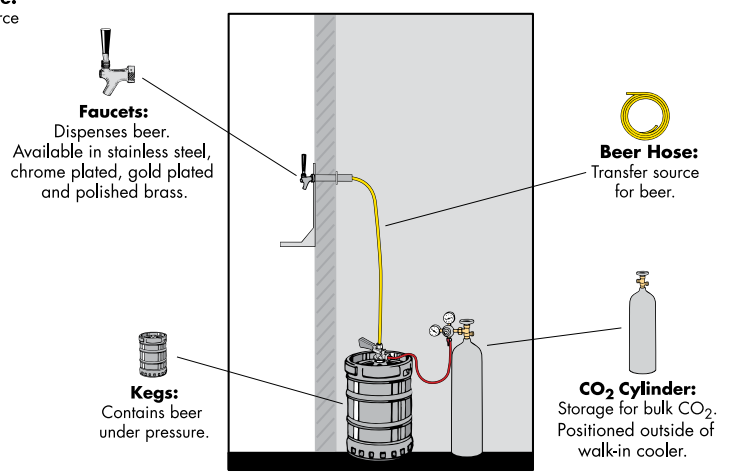
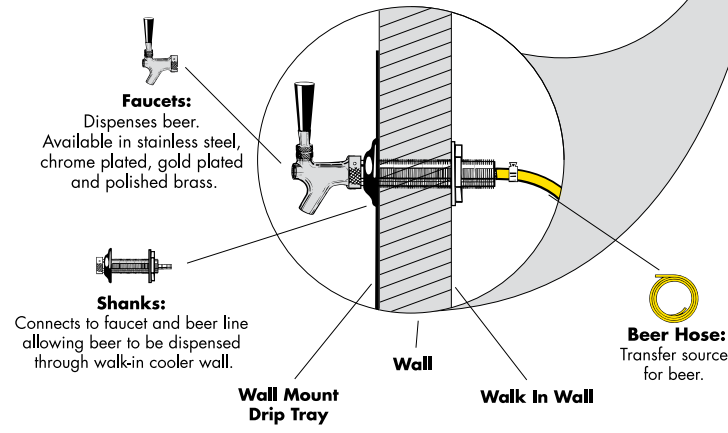

**Walk-in Cooler  
Side Connection View**

An installer checklist can be found on the last four pages of this section to help build a complete beer dispensing system.

*Diagram is courtesy of Micro Matic USA, Inc.*

## PourMyBeer™ Self Serve Beer Systems

The Pour My Beer system creates a fun, engaging environment for your patrons while remaining extremely efficient and highly profitable for your business. Instantly gratifying and rewarding for your customers, it's a proven traffic driver in hundreds of locations across the U.S.



### Using RFID Technology

- Creates talk value, customer curiosity, new business
- Customers fill at their leisure and pay for every drop
- Customers enjoy sampling without buying a full pint
- Customers can earn rewards for bar loyalty
- When customers hit their limit your staff can instantly grant them access to more beer, if they deem fit, via the staff-accessed controller
- Comprehensive reports allow managers to see what's working, what's not, and how customers are interacting with your brand
- Track who's visiting your establishment, when they're visiting, and what they're drinking
- Secure data is saved to a cloud database for easy access whenever you need it
- Monthly fee covers software licensing, 24/7 support, uptime guarantee, latest software updates, and all parts under normal wear
- Return on the cost per line as little as 2-3 kegs poured



**The HD screen** has all the technology built into it: RFID reader/writer, network cables, power line, and flowmeter valve. Screens can be mounted on the table, custom tower or wall. Plug it in and you have beer flowing in no time!



HD screen  
6" wide x 7" tall



Card loader

**The RFID card loader** comes with and plugs into the check-in area and is used to load customer cards with a dollar amount. It also manages staff, admin and line cleaning cards and responsibilities.

**The check-in area** is where your staff will manage all the tabs, whether they are pre-paid or post-paid transactions. All of the reporting can be accessed here, including custom reports.

**RFID cards** come with instructions on the back and the PourMyBeer logo on the front. Custom logos can be added for a small set-up fee. Every two drinks, service will be paused until a staff member deems the customer eligible to re-serve.



**Pour My Beer systems** can be used in countless venues; bars, restaurants, hotels, casinos, stadiums, cruise ships, and more. Products fall into four categories (details on the next page):

- Mobile walls
- Built-in walls
- Mobile tables
- Built-in tables

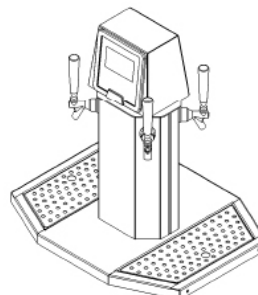

Custom tower with built-in HD screen and drip tray for mobile or built-in tables



## PourMyBeer™ Self Serve Beer Systems

### Mobile Beer Table

The world's only self-contained, refrigerated, customer self-serve beer table...on wheels! The mobile table is complete with it's own gas system, FOB's, flow control and metering technology, and can dispense two different brands. Kegs are kept at 34°F hidden behind lockable doors. Drip tray catches any potential spillage and it drains into a secure container in the keg chamber. The tower features one screen per side with two taps. Screen displays consumer data and brand details. Tables are turned on and off with the touch screen controllers. A magnetic key allows secure access to the self-serve system.



Mobile beer table

### Built-In Beer Table

Built-in beer tables can have screens built into the proprietary beer towers, or screens can be mounted on the tables or a nearby wall. The number of towers, taps, and their location are customizable to fit your establishment's needs. Tables are turned on and off with the touch screen controllers and a magnetic key.



Built-in beer table

### Built-In Beer Wall

Fully customizable, serve as many types of beer or wine from as many taps as you desire. Kegs are stored in your cooler. Optional display screens can be linked to one, two or four taps. The display screen shows the available funds, and a real time drink meter that goes down as drinks are poured.



Built-in beer wall

### Mobile Beer/Wine Wall

A state of the art, fully functional, self-contained beer system on wheels! Stainless steel unit includes taps, RFID readers, keg couplers, flow control, FOBs and refrigeration unit. The 84" mobile wall has four or six taps and houses four full kegs, four slim quarter kegs or sixtels, or twelve 1/6 kegs. The 60" unit comes with four taps. Refrigeration keeps kegs at a cool 34°F. Both 84" and 60" mobile walls can be ordered with dual refrigeration zones for serving beer and wine.



Mobile beer wall

## PourMyBeer™ Self Serve Beer Systems

This unique system can be used with any liquid – beer, wine, cocktails, coffee, Kombucha, etc. If you are interested in learning more about these systems and looking for inspiration visit [www.pourmybeer.com](http://www.pourmybeer.com). If you'd like help designing and quoting a system call us at the phone number above.

Part Number	Description
PMB-1T1S	1 screen/1 tap with flow control
PMB-2T1S	1 screen/2 taps with flow control
PMB-3T1S	1 screen/3 taps with flow control
PMB-4T1S	1 screen/4 taps with flow control
PMB-PWRSUP	Power supply (1 needed for every four taps)
PMB-TMNT	Custom rotating mount for table top
PMB-CKIN	RFID check-in area (hardware/software)
PMB-CKIN2	Additional check-in area
PMB-PRNT	Printer
PMB-SERVER	Server
PMB-LOADER	Card loader
PMB-CARD	RFID customer card (one card)



HD screen



RFID card



Check-in area



Rotating mount



Custom tower with built-in screen

## Lancer Flooded Beer Dispensing Towers

All towers are glycol cooled, fully flooded, will condensate, and in the right conditions will ice over. High polished stainless finish is standard, other finishes are available. 3/16" restrictor lines. Decal disks optional.

Drip trays, Lancer Hilight faucets and Fatlock adaptors are sold separately.



Part Number	Faucets	Description	Drip Tray
23-1560-02-06	6	Goalpost 3" 6W 15" HP SS	36000011
23-1560-02-08	8	Goalpost 3" 8W 15" HP SS	23-1600
23-1560-02-10	10	Goalpost 3" 10W 15" HP SS	23-1600
23-1560-02-12	12	Goalpost 3" 12W 15" HP SS	23-1601
23-1561-02-06	6	Bridge tower 6W	23-1585
23-1561-02-08	8	Bridge tower 8W	23-1600
23-1561-02-10	10	Bridge tower 10W	23-1600
23-1561-02-12	12	Bridge tower 12W	23-1601
23-1563-02-04	4	Harbor tower 4W HP SS	23-1582
23-1563-02-06	6	Harbor tower 6W HP SS	23-1585
23-1563-02-08	8	Harbor tower 8W HP SS	23-1587
23-1563-02-10	10	Harbor tower 10W HP SS	23-1600
23-1563-02-12	12	Harbor tower 12W HP SS	23-1601
23-1566-01-04	4	Zenith tower LH 4W HP SS	23-1582
23-1566-02-04	4	Zenith tower RH 4W HP SS	23-1582
23-1566-01-05	5	Zenith tower LH 5W HP SS	23-1585
23-1566-02-05	5	Zenith tower RH 5W HP SS	23-1585
23-1566-01-06	6	Zenith tower LH 6W HP SS	23-1585
23-1566-02-06	6	Zenith tower RH 6W HP SS	23-1585
23-1574-06-04	4	Double Zenith 4W SS HP	23-1582
23-1574-06-05	5	Double Zenith 5W SS HP	23-1582
23-1574-06-06	6	Double Zenith 6W SS HP	23-1585
23-1574-06-07	7	Double Zenith 7W SS HP	36000011
23-1574-06-08	8	Double Zenith 8W SS HP	23-1600
23-1574-06-10	10	Double Zenith 10W SS HP	23-1600
23-1574-06-12	12	Double Zenith 12W SS HP	23-1601
23-1570-01-03	3	Jupiter tower 3W 15" LH HP	23-1581
23-1570-02-03	3	Jupiter tower 3W 15" RH HP	23-1581
23-1570-01-04	4	Jupiter tower 4W 15" LH HP	23-1582
23-1570-02-04	4	Jupiter tower 4W 15" RH HP	23-1582
82-4488	24	Boulevard tower	

*Glycol is shown on page 43*

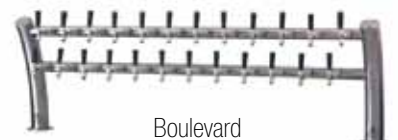
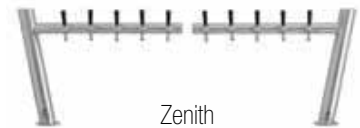
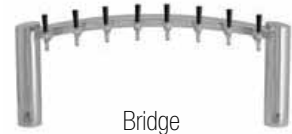



## Lancer Flooded Beer Dispensing Towers

All towers are glycol cooled, fully flooded, will condensate, and in the right conditions will ice over. High polished stainless steel finish is standard, other finishes are available. 3/16" restrictor lines. Decal disks optional.

Drip trays, Lancer Hilight faucets and Fatlock adaptors are sold separately.

Part Number	Faucets	Description	Drip Tray
23-1588-02-04	4	Bondi tower 4W RH SS HP	23-1585
23-1588-01-04	4	Bondi tower 4W LH SS HP	23-1585
23-1574-04-04	4	Cooly tower 4W SS HP	23-1582
23-1574-04-06	6	Cooly tower 6W SS HP	23-1585
23-1574-04-08	8	Cooly tower 8W SS HP	23-1587
23-1574-05-06	6	Whaletail tower 6W SS HP	23-1585
23-1574-05-07	7	Whaletail tower 7W SS HP	36000011
23-1574-05-08	8	Whaletail tower 8W SS HP	23-1587
23-1589-01-06	6	X-Treme tower 6W SS HP with faucets and adaptors	23-1601
23-1573-04-02	2	T-Bar tower 2W 15" S/S HP	36641477
23-1573-04-03	3	T-Bar tower 3W 15" S/S HP	23-1586
23-1573-04-04	4	T-Bar tower 4W 15" S/S HP	23-1581
23-1573-04-05	5	T-Bar tower 5W 15" S/S HP	23-1582
23-1573-04-06	6	T-Bar tower 6W 15" S/S HP	23-1582
23-1574-01-04	4	Fat Boy 4 faucet SS HP	23-1581

*Glycol is shown on page 43*

## Lancer Breeze and BreezeR

Serve cold beer from an ambient keg, from a compact, appealing dispenser with a special tap to create creamy long-lasting foam. Dispensers have a small footprint and can be placed on any countertop, front bar or back bar. Perfect for portable bars, special events, caterers, golf clubs, microbreweries, home use and more.

Breeze ice cooled beer dispenser requires no refrigeration, no electricity and there are no moving parts. Ice capacity: 22 lbs. Ice lasts for 8 hours depending on use. Casual drink temperature is 36°F. Required: a drain for the water from melted ice, CO<sub>2</sub> bottle, CO<sub>2</sub> regulator, keg coupler and hoses. Weight: 63 lbs. 2 year warranty.

BreezeR is refrigerated. Dispensing capacity: 40L 86°F - 46.4°F (30°C - 8°C / 4H). Ice storage capacity: 17.63 lbs. (8kg). Refrigerant 134a. 115V/60Hz.

Part Number	Description
85-51001	Breeze ice cooled beer dispenser
75-51001	Breeze dispenser with C-Tap faucet & handle
75-51001-D	Breeze dispenser kit, D coupler, faucet & handle
75-51001-G	Breeze dispenser kit, G coupler, faucet & handle
78-0167	BreezeR refrigerated beer dispenser & inlet kit



**Breeze**  
11.58" W x 15.55" H  
19.76" D without drip tray  
24.88" D with drip tray



**BreezeR**  
12.99" W x 20.07" H  
20.47" D without drip tray  
25.43" D with drip tray

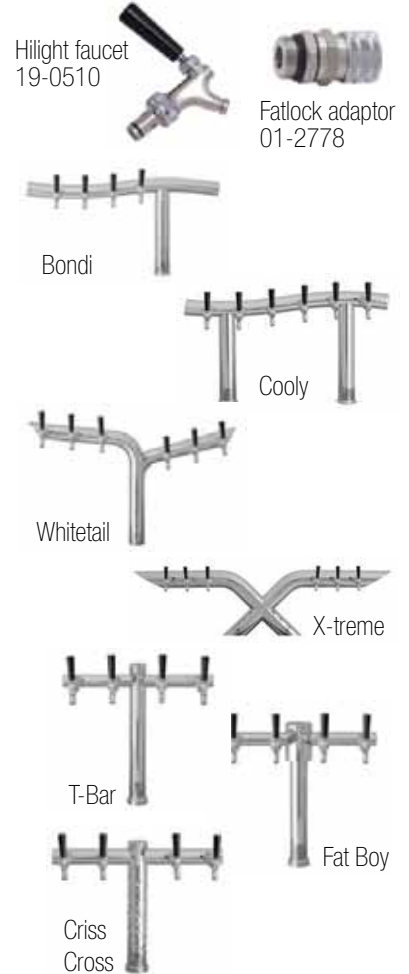

## Beer Dispensing Towers

All towers are 4" diameter, polished stainless steel, glycol cooled and cold blocked unless specified air cooled. American faucets are included. 3/16" restrictor lines. Metro T illuminated towers use an 80mm medallion. Gold, PVD, water, cider, wine and combination beer/wine versions of these towers are available upon request. Contact Lancer Direct for pricing and lead times. Faucets, medallions and tap handles are not included.

Part Number	Faucets	Description	Drip Tray
BB102700-4SSCK	4	Metro "T" tower 4 faucet polished SS	24"
BB102700-6SSCK	6	Metro "T" tower 6 faucet polished SS	24"
BB102701-08SSCK	8	Metro "T" tower 8 faucet polished SS, 30"	30"
BB102701-10SSCK	10	Metro "T" tower 10 faucet polished SS	30"
BB102703-4SSCK	4	Metro "T" tower 4 faucet pol. SS, 80 mm LED med.	24"
BB102703-6SSCK	6	Metro "T" tower 6 faucet pol. SS, 80 mm LED med.	24"
BB102703-8SSCK	8	Metro "T" tower 8 faucet pol. SS, 80 mm LED med.	30"
BB102700-4SS	4	Metro "T" tower 4 faucet air cooled	24"
BB102700-6SS	6	Metro "T" tower 6 faucet air cooled	24"
BB102701-08SS	8	Metro "T" tower 8 faucet air cooled	30"
BB102703-4SS	4	Metro "T" tower 4 faucet air cooled, 80 mm LED med.	24"
BB102703-6SS	6	Metro "T" tower 6 faucet air cooled, 80 mm LED med.	24"
BB102703-8SS	8	Metro "T" tower 8 faucet air cooled, 80 mm LED med.	30"
BB102710-08SSCK	8	Metro "H" tower 8 faucet polished SS	28"
BB102710-10SSCK	10	Metro "H" tower 10 faucet polished SS	34"
BB102710-12SSCK	12	Metro "H" tower 12 faucet polished SS	40"
BB102710-14SSCK	14	Metro "H" tower 14 faucet polished SS	46"
BB102710-16SSCK	16	Metro "H" tower 16 faucet polished SS	52"
BB102715-16SSCK	16	Metro "M" tower 16 faucet polished SS	(2) 28"
BB102715-20SSCK	20	Metro "M" tower 20 faucet polished SS	(2) 34"
BB102715-24SSCK	24	Metro "M" tower 24 faucet polished SS	(2) 40"
BB102725-24SSCK	24	Metro "HHH" tower 24 faucet polished SS	(3) 28"
BB102725-30SSCK	30	Metro "HHH" tower 30 faucet polished SS	(3) 34"
BB102725-36SSCK	36	Metro "HHH" tower 36 faucet polished SS	(3) 40"
BB101379-06CK	6	4" Pass Thru tower 6 faucet brushed SS	30"
BB101379-08CK	8	4" Pass Thru tower 8 faucet brushed SS	30"
BB101379-10CK	10	4" Pass Thru tower 10 faucet brushed SS	36"
BB101379-12CK	12	4" Pass Thru tower 12 faucet brushed SS	45"
BB101379-14CK	14	4" Pass Thru tower 14 faucet brushed SS	45"
BB101379-16CK	16	4" Pass Thru tower 16 faucet brushed SS	51"
BB101379-06	6	4" Pass Thru 6 faucet air cooled brushed SS	30"
BB101379-08	8	4" Pass Thru 8 faucet air cooled brushed SS	30"
BB101379-10	10	4" Pass Thru 10 faucet air cooled brushed SS	36"
BB101379-12	12	4" Pass Thru 12 faucet air cooled brushed SS	45"
BB101379-14	14	4" Pass Thru 14 faucet air cooled brushed SS	45"
BB101382C-06CK	6	4" Pass Thru 6 faucet pol. SS, 80 mm LED med.	30"
BB101382C-08CK	8	4" Pass Thru 8 faucet pol. SS, 80 mm LED med.	36"
BB101382C-10CK	10	4" Pass Thru 10 faucet pol. SS, 80 mm LED med.	45"
BB101382C-12CK	12	4" Pass Thru 12 faucet pol. SS, 80 mm LED med.	51"

**Tap handles and medallions are shown on pages 24-27**



Metro T



Metro T



Metropolis H



Metropolis M



Metro HHH



4" Pass Thru

## Beer Dispensing Towers

Most towers are glycol cooled and cold blocked. American faucets are included. 3/16" restrictor lines. Gold, PVD, water, cider, wine and combination beer/wine versions of these towers are available upon request. Contact Lancer Direct for pricing and lead times. Faucets, medallions and tap handles are not included.

Differentiations between the Bixby, Lions Gate, and Bridge: The Bixby and Bridge do not have a flange between the faucets, the Lions Gate does have a flange between the faucets. The Bridge is 3" diameter, all others on this page are 4" diameter.

Part Number	Faucets	Description	Drip Tray
BB102932-04SSCK	4	Bixby tower 4 faucet polished SS LED med.	20"
BB102932-05SSCK	5	Bixby tower 5 faucet polished SS LED med.	24"
BB102932-06SSCK	6	Bixby tower 6 faucet polished SS LED med.	30"
BB102932-07SSCK	7	Bixby tower 7 faucet polished SS LED med.	30"
BB102932-08SSCK	8	Bixby tower 8 faucet polished SS LED med.	36"
BB102632-04SSCK	4	Bixby tower 4 faucet polished SS	20"
BB102632-05SSCK	5	Bixby tower 5 faucet polished SS	24"
BB102632-06SSCK	6	Bixby tower 6 faucet polished SS	30"
BB102632-07SSCK	7	Bixby tower 7 faucet polished SS	30"
BB102632-08SSCK	8	Bixby tower 8 faucet polished SS	36"
BB102637-10SSCK	10	Bixby 3 pedestal tower 10 faucet polished SS	(2) 24"
BB102637-12SSCK	12	Bixby 3 pedestal tower 12 faucet polished SS	(2) 36"
BB102637-14SSCK	14	Bixby 3 pedestal tower 14 faucet polished SS	(4) 20"
BB102637-16SSCK	16	Bixby 3 pedestal tower 16 faucet polished SS	(2) 51"
BB102930-06SSC	6	Lions Gate tower 6 faucet polished SS LED med.	30"
BB102930-08SSC	8	Lions Gate tower 8 faucet polished SS LED med.	36"
BB102930-10SSC	10	Lions Gate tower 10 faucet polished SS LED med.	45"
BB102930-12SSC	12	Lions Gate tower 12 faucet polished SS LED med.	51"
BB102930-14SSC	14	Lions Gate tower 14 faucet polished SS LED med.	(2) 30"
BB102630-06SSCK	6	Lions Gate tower 6 faucet polished SS	30"
BB102630-08SSCK	8	Lions Gate tower 8 faucet polished SS	36"
BB102630-10SSCK	10	Lions Gate tower 10 faucet polished SS	45"
BB102630-12SSCK	12	Lions Gate tower 12 faucet polished SS	51"
BB102630-14SSCK	14	Lions Gate tower 14 faucet polished SS	(2) 30"
BB102635-12SSC	12	Lions gate column 12 faucet polished SS	(2) 24"
BB102635-16SSC	16	Lions gate column 16 faucet polished SS	(2) 36"
BB102635-20SSC	20	Lions gate column 20 faucet polished SS	(4) 20"
BB102635-24SSC	24	Lions gate column 24 faucet polished SS	(2) 51"
BB102770-06SSCK	6	Bridge tower 6 faucet polished SS	20"
BB102770-08SSCK	8	Bridge tower 8 faucet polished SS	24"
BB102770-10SSCK	10	Bridge tower 10 faucet polished SS	30"
BB102770-12SSCK	12	Bridge tower 12 faucet polished SS	36"
BB102775-06SS	6	Low Bridge tower 6 faucet polished SS air cooled	20"
BB102775-08SS	8	Low Bridge tower 8 faucet polished SS air cooled	24"
BB102775-10SS	10	Low Bridge tower 10 faucet polished SS air cooled	30"
BB102775-12SS	12	Low Bridge tower 12 faucet polished SS air cooled	36"
BB102775-06SSCK	6	Low Bridge tower 6 faucet polished SS	20"
BB102775-08SSCK	8	Low Bridge tower 8 faucet polished SS	24"
BB102775-10SSCK	10	Low Bridge tower 10 faucet polished SS	30"
BB102775-12SSCK	12	Low Bridge tower 12 faucet polished SS	36"



Lit Bixby



Bixby



Bixby Pedestal

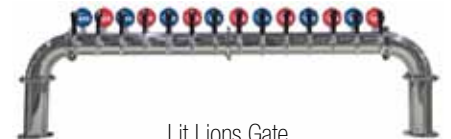

Lit Lions Gate



Lions Gate



Lions Gate Column



Bridge

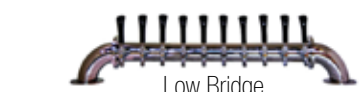

Low Bridge

## Beer Dispensing Towers

Most towers are glycol cooled and cold blocked. American faucets are included. 3/16" restrictor lines. Gold, PVD, water, cider, wine and combination beer/wine versions of these towers are available upon request. Contact Lancer Direct for pricing and lead times. Faucets, medallions and tap handles are not included.

Part Number	Faucets	Description	Drip Tray
BB102915-02SSCK	2	Linx Lit L7 tower 2 faucet polished SS LED	12"
BB102915-03SSCK	3	Linx Lit L7 tower 3 faucet polished SS LED	12"
BB102915-04SSCK	4	Linx Lit L7 tower 4 faucet polished SS LED	16"
BB102915-05SSCK	5	Linx Lit L7 tower 5 faucet polished SS LED	20"
BB102915-06SSCK	6	Linx Lit L7 tower 6 faucet polished SS LED	24"
BB102615-02SSC	2	Linx L7 tower 2 faucet polished SS	12"
BB102615-03SSC	3	Linx L7 tower 3 faucet polished SS	12"
BB102615-04SSC	4	Linx L7 tower 4 faucet polished SS	16"
BB102615-05SSC	5	Linx L7 tower 5 faucet polished SS	20"
BB102615-06SSC	6	Linx L7 tower 6 faucet polished SS	24"
BB102617-02SSC	2	Linx R7 tower 2 faucet polished SS	12"
BB102617-03SSC	3	Linx R7 tower 3 faucet polished SS	12"
BB102617-04SSC	4	Linx R7 tower 4 faucet polished SS	16"
BB102617-05SSC	5	Linx R7 tower 5 faucet polished SS	20"
BB102617-06SSC	6	Linx R7 tower 6 faucet polished SS	24"
BB102920-04SSCK	4	Albatross tower 4 faucet polished SS LED med.	12"
BB102920-06SSCK	6	Albatross tower 6 faucet polished SS LED med.	12"
BB102920-08SSCK	8	Albatross tower 8 faucet polished SS LED med.	16"
BB102920-10SSCK	10	Albatross tower 10 faucet polished SS LED med.	20"
BB102620-04SSC	4	Albatross tower 4 faucet polished SS	12"
BB102620-06SSC	6	Albatross tower 6 faucet polished SS	12"
BB102620-08SSC	8	Albatross tower 8 faucet polished SS	16"
BB102620-10SSC	10	Albatross tower 10 faucet polished SS	20"

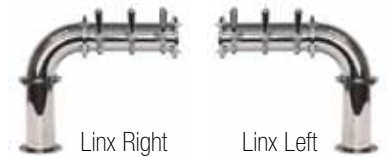

*Tap handles and medallions are shown on pages 24-27*

## Beer Dispensing Towers

All towers are glycol cooled and cold blocked. American faucets are included. 3/16" restrictor lines. Water, cider, wine and combination beer/wine versions of these towers are available upon request. Contact Lancer Direct for pricing and lead times. Faucets, medallions and tap handles are not included.

Part Number	Faucets	Description	Drip Tray
BB102765-06SSCK	6	Rail tower 6 faucet polished SS	20"
BB102765-08SSCK	8	Rail tower 8 faucet polished SS	24"
BB102765-10SSCK	10	Rail tower 10 faucet polished SS	30"
BB102765-12SSCK	12	Rail tower 12 faucet polished SS	36"
BB102765-06SS	6	Rail tower 6 faucet polished SS air cooled	20"
BB102765-08SS	8	Rail tower 8 faucet polished SS air cooled	24"
BB102765-10SS	10	Rail tower 10 faucet polished SS air cooled	30"
BB102765-12SS	12	Rail tower 12 faucet polished SS air cooled	36"
BB103373C-CK	3	Lantern wall mount tower chrome 3 faucets	12" x 7"
BB103374C-CK	4	Lantern wall mount tower chrome 4 faucets	16" x 7"
BB103375C-CK	5	Lantern wall mount tower chrome 5 faucets	16" x 7"
BB103373C	3	Lantern wall mount tower chrome 3 faucets air cooled	12" x 7"
BB103374C	4	Lantern wall mount tower chrome 4 faucets air cooled	16" x 7"
BB103375C	5	Lantern wall mount tower chrome 5 faucets air cooled	16" x 7"
BB101384C-CK	4	Mushroom large tower polished SS 4 faucets	19"
BB101385C-CK	5	Mushroom large tower polished SS 5 faucets	19"
BB101386C-CK	6	Mushroom large tower polished SS 6 faucets	24"
BB101384C	4	Mushroom large polished SS 4 faucets air cooled	19"
BB101385C	5	Mushroom large polished SS 5 faucets air cooled	19"
BB101386C	6	Mushroom large polished SS 6 faucets air cooled	24"
BB101373C-CK	3	Mushroom mini tower chrome 3 faucets	14"
BB101374C-CK	4	Mushroom mini tower chrome 4 faucets	18"
BB101375C-CK	5	Mushroom mini tower chrome 5 faucets	18"
BB101373C	3	Mushroom mini tower chrome 3 faucets air cooled	14"
BB101374C	4	Mushroom mini tower chrome 4 faucets air cooled	18"
BB101375C	5	Mushroom mini tower chrome 5 faucets air cooled	18"



Rail



Lantern



Mushroom

*Tap handles and medallions are shown on pages 24-27*

## European Beer Dispensing Towers

All towers are glycol cooled and cold blocked. American faucets are included. 3/16" restrictor lines.  
Water, cider, wine and combination beer/wine versions of these towers are available upon request.  
Contact Lancer Direct for pricing and lead times. Faucets and tap handles are not included.

Part Number	Faucets	Description	Drip Tray
BB101370CB-CK	3	Zeus tower chrome/black 3 faucet	20"
BB101370CG-CK	3	Zeus tower chrome/green 3 faucet	20"
BB101370CN-CK	3	Zeus tower chrome/blue 3 faucet	20"
BB101370CW-CK	3	Zeus tower chrome/white 3 faucet	20"
BB101370GB-CK	3	Zeus tower gold/black 3 faucet	20"
BB101370GG-CK	3	Zeus tower gold/green 3 faucet	20"
BB101370GN-CK	3	Zeus tower gold/blue 3 faucet	20"
BB101370GW-CK	3	Zeus tower gold/white 3 faucet	20"
BB101370CB	3	Zeus tower chrome/black 3 faucet air cooled	20"
BB101370CG	3	Zeus tower chrome/green 3 faucet air cooled	20"
BB101370CN	3	Zeus tower chrome/blue 3 faucet air cooled	20"
BB101370CW	3	Zeus tower chrome/white 3 faucet air cooled	20"
BB101370GB	3	Zeus tower gold/black 3 faucet air cooled	20"
BB101370GG	3	Zeus tower gold/green 3 faucet air cooled	20"
BB101370GN	3	Zeus tower gold/blue 3 faucet air cooled	20"
BB101370GW	3	Zeus tower gold/white 3 faucet air cooled	20"
BB101371CB-CK	4	Zeus tower chrome/black 4 faucet	20"
BB101371CG-CK	4	Zeus tower chrome/green 4 faucet	20"
BB101371CN-CK	4	Zeus tower chrome/blue 4 faucet	20"
BB101371CW-CK	4	Zeus tower chrome/white 4 faucet	20"
BB101371GB-CK	4	Zeus tower gold/black 4 faucet	20"
BB101371GG-CK	4	Zeus tower gold/green 4 faucet	20"
BB101371GN-CK	4	Zeus tower gold/blue 4 faucet	20"
BB101371GW-CK	4	Zeus tower gold/white 4 faucet	20"
BB101371CB	4	Zeus tower chrome/black 4 faucet air cooled	20"
BB101371CG	4	Zeus tower chrome/green 4 faucet air cooled	20"
BB101371CN	4	Zeus tower chrome/blue 4 faucet air cooled	20"
BB101371CW	4	Zeus tower chrome/white 4 faucet air cooled	20"
BB101371GB	4	Zeus tower gold/black 4 faucet air cooled	20"
BB101371GG	4	Zeus tower gold/green 4 faucet air cooled	20"
BB101371GN	4	Zeus tower gold/blue 4 faucet air cooled	20"
BB101371GW	4	Zeus tower gold/white 4 faucet air cooled	20"
BB101372CB-CK	5	Zeus tower chrome / black 5 faucet	20"
BB101372CG-CK	5	Zeus tower chrome/green 5 faucet	20"
BB101372CN-CK	5	Zeus tower chrome/blue 5 faucet	20"
BB101372CW-CK	5	Zeus tower chrome/white 5 faucet	20"
BB101372GB-CK	5	Zeus tower gold / black 5 faucet	20"
BB101372GG-CK	5	Zeus tower gold/green 5 faucet	20"
BB101372GN-CK	5	Zeus tower gold/blue 5 faucet	20"
BB101372GW-CK	5	Zeus tower gold/white 5 faucet	20"
BB101372CB	5	Zeus tower chrome / black 5 faucet air cooled	20"
BB101372CG	5	Zeus tower chrome/green 5 faucet air cooled	20"
BB101372CN	5	Zeus tower chrome/blue 5 faucet air cooled	20"
BB101372CW	5	Zeus tower chrome/white 5 faucet air cooled	20"
BB101372GB	5	Zeus tower gold / black 5 faucet air cooled	20"
BB101372GG	5	Zeus tower gold/green 5 faucet air cooled	20"
BB101372GN	5	Zeus tower gold/blue 5 faucet air cooled	20"
BB101372GW	5	Zeus tower gold/white 5 faucet air cooled	20"



Zeus  
Zeus towers are available with black, green, blue or white ceramic, and chrome or gold metal

## European Beer Dispensing Towers

All towers are glycol cooled and cold blocked unless specified air cooled. American faucets are included. 3/16" restrictor lines. Gold, PVD, water, cider, wine and combination beer/wine versions of these towers are available upon request. Contact Lancer Direct for pricing and lead times. Faucets, medallions and tap handles are not included.

Part Number	Faucets	Description	Drip Tray
BB102050-3CK	3	Brigitte tower 3 faucet chrome glycol cooled, LED medallions	20"
BB102050-5CK	5	Brigitte tower 5 faucet chrome glycol cooled, LED medallions	24"
BB102050-7CK	7	Brigitte tower 7 faucet chrome glycol cooled, LED medallions	36"
BB102300A-CK	2	Monaco tower 2 faucet chrome	20"
BB102310A-CK	3	Monaco tower 3 faucet chrome	20"
BB102315A-CK	4	Monaco tower 4 faucet chrome	24"
BB102320A-CK	5	Monaco tower 5 faucet chrome	24"
BB102325A-CK	6	Monaco tower 6 faucet chrome	36"
BB102330A-CK	7	Monaco tower 7 faucet chrome	36"
BB102300A	2	Monaco tower 2 faucet chrome air cooled	20"
BB102310A	3	Monaco tower 3 faucet chrome air cooled	20"
BB102315A	4	Monaco tower 4 faucet chrome air cooled	24"
BB102320A	5	Monaco tower 5 faucet chrome air cooled	24"
BB102325A	6	Monaco tower 6 faucet chrome air cooled	36"
BB102330A	7	Monaco tower 7 faucet chrome air cooled	36"
BB102370A-CK	1	Idea tower 1 faucet chrome glycol cooled	10"
BB102373C-CK	1	Idea tower 1 faucet chrome glycol cooled, 82 mm LED medallion	10"
BB102375A-CK	2	Idea tower 2 faucet chrome glycol cooled	10"
BB102373C	1	Idea tower 1 faucet chrome air cooled, 82 mm LED medallion	10"
BB102370A	1	Idea tower 1 faucet chrome air cooled	10"
BB102375A	2	Idea tower 2 faucet chrome air cooled	10"
BB102140A-CK	1	Mongoose tower 1 faucet chrome	10"
BB102150A-CK	2	Mongoose tower 2 faucet chrome	10"
BB102160A-CK	3	Mongoose tower 3 faucet chrome	15"
BB102170A-CK	4	Mongoose tower 4 faucet chrome	15"
BB102140A	1	Mongoose tower 1 faucet chrome air cooled	10"
BB102150A	2	Mongoose tower 2 faucet chrome air cooled	10"
BB102160A	3	Mongoose tower 3 faucet chrome air cooled	15"
BB102170A	4	Mongoose tower 4 faucet chrome air cooled	15"
BB102175A-CK	4	Mongoose tower 4 faucet chrome, LED medallions	15"
BB102142A-CK	1	Mongoose tower 1 faucet black nickel	10"
BB102152A-CK	2	Mongoose tower 2 faucet black nickel	10"
BB102162A-CK	3	Mongoose tower 3 faucet black nickel	15"
BB102172A-CK	4	Mongoose tower 4 faucet black nickel	15"
BB102177A-CK	4	Mongoose tower 4 faucet black nickel, LED medallions	15"



*Tap handles and medallions are shown on pages 24-27*

## European Beer Dispensing Towers

All towers are glycol cooled and cold blocked unless specified air cooled. American brass faucets are included. 3/16" 304SS shanks and lines (except Sexy and Lucky air cooled). Gold, PVD, water, cider, wine and combination beer/wine versions of these towers are available upon request. Contact us for pricing and lead times. Faucets, medallions and tap handles are not included.

Part Number	Faucets	Description	Drip Tray
BB102060C-1A	1	Sexy tower 1 faucet chrome air cooled for keg cooler	10"
BB102091A-CK	1	Sexy tower 1 faucet chrome glycol cooled	10"
BB102095A-CK	1	Sexy tower 1 faucet chrome glycol cooled, LED medallion	10"
BB102060C-2A	2	Sexy tower 2 faucet chrome air cooled for keg cooler	10"
BB102092A-CK	2	Sexy tower 2 faucet chrome glycol cooled	10"
BB102096A-CK	2	Sexy tower 2 faucet chrome glycol cooled, LED medallions	10"
BB102093A-CK	3	Sexy tower 3 faucet chrome glycol cooled	15"
BB102097A-CK	3	Sexy tower 3 faucet chrome glycol cooled, LED medallions	15"
BB102094A-CK	4	Sexy tower 4 faucet chrome glycol cooled	15"
BB102098A-CK	4	Sexy tower 4 faucet chrome glycol cooled, LED medallions	15"
BB102095A-ICE	1	Sexy ice tower 1 faucet chrome glycol cooled	10"
BB102061A-ICE	1	Sexy ice tower 1 faucet chrome glycol cooled, LED medallion	10"
BB102096A-ICE	2	Sexy ice tower 2 faucet chrome glycol cooled	10"
BB102062A-ICE	2	Sexy ice tower 2 faucet chrome glycol cooled, LED medallions	10"
BB102097A-ICE	3	Sexy ice tower 3 faucet chrome glycol cooled	15"
BB102063A-ICE	3	Sexy ice tower 3 faucet chrome glycol cooled, LED medallions	15"
BB102098A-ICE	4	Sexy ice tower 4 faucet chrome glycol cooled	15"
BB102064A-ICE	4	Sexy ice tower 4 faucet chrome glycol cooled, LED medallions	15"
BB102077C-CK	1	Super Sexy tower 1 faucet chrome glycol cooled	10"
BB102078C-CK	2	Super Sexy tower 2 faucet chrome glycol cooled	10"
BB102107A-CK	3	Panther tower 3 faucet chrome, LED medallions	15"
BB102105A-CK	3	Panther tower 3 faucet chrome	15"
BB102110A-CK	4	Panther tower 4 faucet chrome	15"
BB102108A-ICE	3	Panther ice tower 3 faucet chrome, LED medallions	15"
BB102105A-ICE	3	Panther ice tower 3 faucet chrome	15"
BB102110A-ICE	4	Panther ice tower 4 faucet chrome	15"
BB102123A-ICE	1	Lucky ice tower 1 faucet chrome glycol flooded	10"
BB102127A-ICE	2	Lucky ice tower 2 faucet chrome glycol flooded	10"
BB102122C-1A	1	Lucky tower 1 faucet chrome air cooled	10"
BB102122A-CK	1	Lucky tower 1 faucet chrome glycol cooled	10"
BB102123A-CK	1	Lucky tower 1 faucet chrome glycol cooled, LED medallion	10"
BB102122C-2A	2	Lucky tower 2 faucet chrome air cooled	10"
BB102125A-CK	2	Lucky tower 2 faucet chrome glycol cooled	10"
BB102130A-CK	2	Lucky tower 2 faucet chrome glycol cooled, LED medallions	10"
BB102132A-CK	3	Lucky tower 3 faucet chrome glycol cooled	15"
BB102133A-CK	3	Lucky tower 3 faucet chrome glycol cooled, LED medallions	15"



Sexy chrome



Sexy ice with medallions



Super Sexy



Panther



Panther Ice

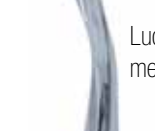

Lucky with/without medallions

*Tap handles and medallions are shown on pages 24-27*



## European Beer Dispensing Towers

All towers are glycol cooled and cold blocked unless specified air cooled. American brass faucets are included. 3/16" 304SS lines and 304SS shanks. Gold, PVD, water, cider, wine and combination beer/wine versions of these towers are available upon request. Contact Lancer Direct for pricing and lead times. Faucets, medallions and tap handles are not included.

Part Number	Faucets	Description	Drip Tray
BB102113AC-CK	1	Shield tower 1 faucet chrome glycol cooled lit teardrop	10"
BB102114AC-CK	2	Shield tower 2 faucet chrome glycol cooled lit teardrop	10"
BB102116AC-CK	2	Shield tower 2 faucet chrome glycol cooled lit teardrop, LED medallions	10"
BB102115AC-CK	3	Shield tower 3 faucet chrome glycol cooled lit teardrop	15"
BB102117AC-CK	3	Shield tower 3 faucet chrome glycol cooled lit teardrop, LED medallions	15"
BB102346A-CK	1	Tango tower chrome 1 faucet glycol cooled, 82 mm LED medallion	10"
BB102360A-CK	1	Apollo tower chrome 1 faucet	10"
BB102364A-CK	1	Apollo tower chrome 1 faucet, oval 82 mm LED medallion	10"
BB102366A-CK	1	Apollo tower stainless steel 1 faucet	10"
BB102368A-CK	1	Apollo lit tower stainless steel 1 faucet	10"

*Tap handles and medallions are shown on pages 24-27*



## Custom Branded and Designed Towers

Part Number	Description
CUSTBRANDDISP	Custom branded beverage dispenser
CUSTTOWER	Custom branded tower designed to your specifications (TV tower shown)



*See page 26 for custom graphics lead times*

## Tower Bolts

Part Number	Description
BB810010	1.5" x 4.33" standard tower bolt for air drawn tower
BB810013	1.5" x 7" extended tower bolt for air drawn tower thru counter top
BB810016	1.5" x 10.95" extended tower bolt for air drawn tower thru counter top
BB810025	1.5" sealing nut for tower bolt
BB810028	1.5" counter nut for tower bolt

## Column Beer Dispensing Towers

All towers are glycol cooled and cold blocked unless specified air cooled. American faucets are included. 3/16" restrictor lines. Premium column towers are 100% 304 stainless steel. Decal disks optional. Water, cider and wine versions of these towers are available upon request. Contact Lancer Direct for pricing and lead times. Faucets, medallions and tap handles are not included.

Part Number	Faucets	Description	Drip Tray
BB101402CBS	1	Premium 3" column tower 1 faucet brushed SS air cooled	10"
BB101406CBS	2	Premium 3" column tower 2 faucet brushed SS air cooled	10"
BB101419CBS	3	Premium 3" column tower 3 faucet brushed SS air cooled	15"
BB101406CBS-CK	2	Premium 3" column tower 2 faucet brushed SS glycol cooled	10"
BB101419CBS-CK	3	Premium 3" column tower 3 faucet brushed SS glycol cooled	15"
BB101402	1	3" Column tower 1 faucet chrome, vinyl tubing air cooled	10"
BB101404	1	3" Column tower 1 faucet chrome, SS tubing, air cooled	10"
BB101408	2	3" Column tower 2 faucet chrome, SS tubing, air cooled	10"
BB101422C-CK	4	4" Column tower polished SS, 4 faucets, vinyl tubing	15"
BB101412-C	3	4" Column tower 3 faucet polished SS, vinyl tubing, air cooled	15"
BB101422-C	4	4" Column tower 4 faucet polished SS, vinyl tubing, air cooled	15"
BB101412-SS	3	4" Column tower 3 faucet brushed SS, vinyl tubing, air cooled	15"
BB101422-SS	4	4" Column tower 4 faucet brushed SS, vinyl tubing, air cooled	15"
CUSTWRAPTOWER		Custom branded wrapped column towers	



Brushed



Polished



Custom branded wrapped towers

## 3" Column Tower Accessories

Part Number	Description
CTE16	Add 1 tap to a 1 tap 3" tower, chrome
CTE17	Add 1 or 2 taps to a 1 tap 3" tower, chrome
CTE18	Add 2 taps to a 1 tap 3" tower, chrome
C507	3" dia. tower cap for std draft arm, chrome
C506	3" dia. tower cap for std draft arm, polished brass
D123PA	3" cap with insulation and O-ring, polished chrome
CT3.GSK	Mounting gasket for 3" column tower
CT3.SCR	Mounting screw for tower, SS



CTE17

CTE18

CTE16

C521

C506

CT3.GSK

CT3.SCR

## Clamp-On Beer Dispensing Towers

All towers are glycol cooled and cold blocked unless specified air cooled. Faucets and handles are sold separately. 3/16" restrictor lines. Gold, PVD, water, cider and wine versions of these towers are available upon request. Contact Lancer Direct for pricing and lead times.

Part Number	Faucets	Description
BB103121CC	1	3" Cylinder tower 1 faucet chrome with chrome clamp-on bracket & drip tray
BB103122CC	2	3" Cylinder tower 2 faucet chrome with chrome clamp-on bracket & drip tray
BB103126CC	3	3" Cylinder tower 3 faucet chrome with chrome clamp-on bracket & drip tray
BB103118SSCC	1	3" Cylinder tower 1 faucet (SS) chrome with chrome clamp-on bracket & drip tray
BB103119SSCC	2	3" Cylinder tower 2 faucet (SS) chrome with chrome clamp-on bracket & drip tray
BB103171ACC	1	Mongoose tower chrome 1 US faucet with chrome clamp-on bracket & drip tray
BB103173ACC	2	Mongoose tower chrome 2 US faucet with chrome clamp-on bracket & drip tray
BB103191ACC	1	Sexy tower chrome 1 US faucet with chrome clamp-on bracket & drip tray
BB103193ACC	2	Sexy tower chrome 2 US faucet with chrome clamp-on bracket & drip tray

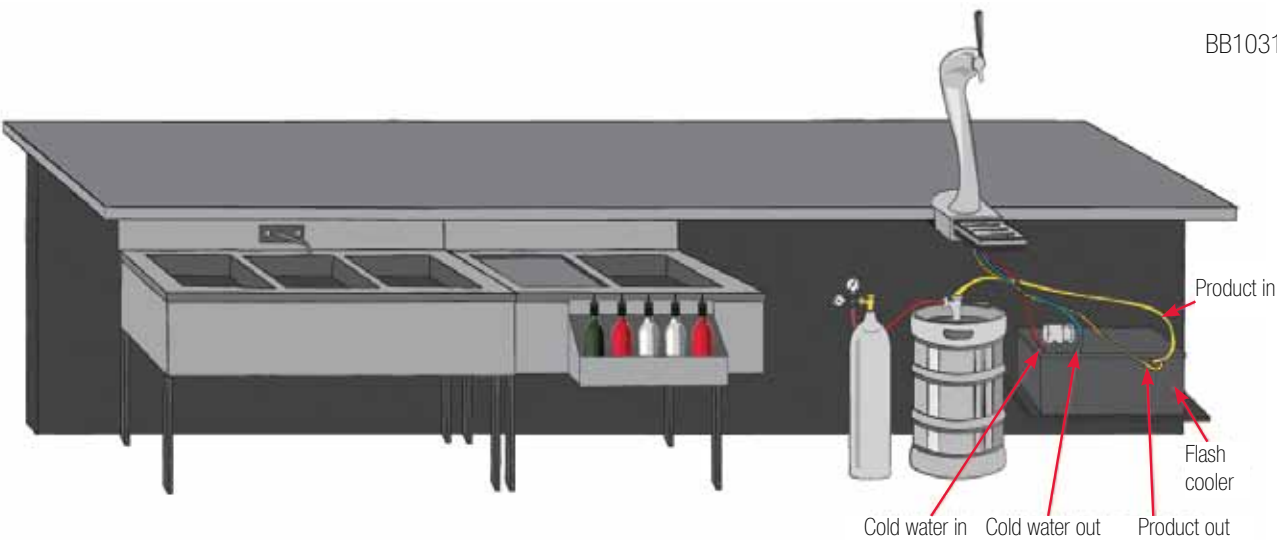

## Kegeator Beer Dispensing Towers

All towers are air cooled, have high polish chrome finish, American brass faucets and short center bolt to mount on kegeator. Faucets and handles are not included.

Part Number	Faucets	Description
BB102060CA-1A	1	Sexy tower 1 faucet chrome air cooled
BB102060CA-2A	2	Sexy tower 2 faucet chrome air cooled
BB102060CA-3A	3	Sexy tower 3 faucet chrome air cooled
BB102060G-1A	1	Sexy tower 1 faucet gold AKT air cooled
BB102060G-2A	2	Sexy tower 2 faucet gold AKT air cooled
BB102122C-1A	1	Lucky tower 1 faucet chrome air cooled
BB102122C-2A	2	Lucky tower 2 faucet chrome air cooled
BB102105A-3A	3	Panther tower 3 faucet chrome air cooled
BB800100	N/A	Complete AKT Air Drawn Kit for air cooled pedestal tower not designed for kegeator



## American Box Beer Dispensing Towers

All towers include American faucets.

Part Number	Faucets	Description	Drip Tray
82-4585	2	T box tower 2 faucet SS glycol cooled	10"
82-4586	3	T box tower 3 faucet SS glycol cooled	10"
82-4587	4	T box tower 4 faucet SS glycol cooled	15"
82-4588	5	T box tower 5 faucet SS glycol cooled	15"
82-4589	6	T box tower 6 faucet SS glycol cooled	20"
82-4590	8	T box tower 8 faucet SS glycol cooled	24"
82-4579	2	T box tower 2 faucet SS air cooled	10"
82-4580	3	T box tower 3 faucet SS air cooled	10"
82-4581	4	T box tower 4 faucet SS air cooled	15"
82-4582	5	T box tower 5 faucet SS air cooled	15"
82-4583	6	T box tower 6 faucet SS air cooled	20"
82-4584	8	T box tower 8 faucet SS air cooled	24"
82-4600	6	Pass Thru box tower 6 faucet SS glycol cooled	24"
82-4601	8	Pass Thru box tower 8 faucet SS glycol cooled	30"
82-4602	10	Pass Thru box tower 10 faucet SS glycol cooled	36"
82-4603	12	Pass Thru box tower 12 faucet SS glycol cooled	42"
82-4604	14	Pass Thru box tower 14 faucet SS glycol cooled	48"
82-4605	16	Pass Thru box tower 16 faucet SS glycol cooled	54"
82-4606	18	Pass Thru box tower 18 faucet SS glycol cooled	60"
82-4607	20	Pass Thru box tower 20 faucet SS glycol cooled	66"
82-4608	24	Pass Thru box tower 24 faucet SS glycol cooled	78"
82-4591	6	Pass Thru box tower 6 faucet SS air cooled	24"
82-4592	8	Pass Thru box tower 8 faucet SS air cooled	30"
82-4593	10	Pass Thru box tower 10 faucet SS air cooled	36"
82-4594	12	Pass Thru box tower 12 faucet SS air cooled	42"
82-4595	14	Pass Thru box tower 14 faucet SS air cooled	48"
82-4596	16	Pass Thru box tower 16 faucet SS air cooled	54"
82-4597	18	Pass Thru box tower 18 faucet SS air cooled	60"
82-4598	20	Pass Thru box tower 20 faucet SS air cooled	66"
82-4599	24	Pass Thru box tower 24 faucet SS air cooled	78"
82-4611	16	Dual side box tower 16 faucet SS glycol	(2) 30"
82-4612	18	Dual side box tower 18 faucet SS glycol	(2) 36"
82-4613	20	Dual side box tower 20 faucet SS glycol	(2) 36"
82-4614	24	Dual side box tower 24 faucet SS glycol	(2) 42"
82-4615	28	Dual side box tower 28 faucet SS glycol	(2) 48"
82-4616	32	Dual side box tower 32 faucet SS glycol	(2) 54"
82-4617	40	Dual side box tower 40 faucet SS glycol	(2) 66"
82-4618	48	Dual side box tower 48 faucet SS glycol	(2) 78"



T Box



T Box



Pass Thru



Pass Thru



Dual Side Pass Thru

## Under Bar and Wall Mount Beer Dispensers

Dispensers are glycol cooled unless specified air cooled. Air cooled under bar dispensers have a 3" OD brass tube 6" long attached to the bottom of the box for easy hook up to the flex pipe. Wall mount boxes are offset 1/2" from the top of the tray so when mounted the tray will be flush mounted to the wall.

8 and 10 faucet dispensers have 2 tubes for pass thru air flow. Box and drip tray are 16 gauge SS with attached 14 gauge SS bracket that wraps around and under the box. Faucets and 6' of tubing are included. Faucets and handles are not included.

Part Number	Description	Drip Tray
BB103614-03	Underbar 14" Space-Mizer dispenser 3 faucets air cooled	15"
BB103614-03CK	Underbar 14" Space-Mizer dispenser 3 faucets	15"
BB103614-04	Underbar 14" Space-Mizer dispenser 4 faucets air cooled	15"
BB103614-04CK	Underbar 14" Space-Mizer dispenser 4 faucets	15"
BB103620-05	Underbar 20" Space-Mizer dispenser 5 faucets air cooled	20"
BB103620-05CK	Underbar 20" Space-Mizer dispenser 5 faucets	20"
BB103620-06	Underbar 20" Space-Mizer dispenser 6 faucets air cooled	20"
BB103620-06CK	Underbar 20" Space-Mizer dispenser 6 faucets	20"
BB103626-08	Underbar 20" Space-Mizer dispenser 8 faucets air cooled	24"
BB103626-08CK	Underbar 20" Space-Mizer dispenser 8 faucets	24"
BB103632-10	Underbar 20" Space-Mizer dispenser 10 faucets air cooled	30"
BB103632-10CK	Underbar 20" Space-Mizer dispenser 10 faucets	30"
BB103638-12	Underbar 20" Space-Mizer dispenser 12 faucets air cooled	36"
BB103638-12CK	Underbar 20" Space-Mizer dispenser 12 faucets	36"
BB103720-04	Underbar 20" cabinet dispenser with drip tray 4 faucets air cooled	Included
BB103720-04CK	Underbar 20" cabinet dispenser with drip tray 4 faucets	Included
BB103720-05	Underbar 20" cabinet dispenser with drip tray 5 faucets air cooled	Included
BB103720-05CK	Underbar 20" cabinet dispenser with drip tray 5 faucets	Included
BB103720-06	Underbar 20" cabinet dispenser with drip tray 6 faucets air cooled	Included
BB103720-06CK	Underbar 20" cabinet dispenser with drip tray 6 faucets	Included
BB103724-08CK	Underbar 24" cabinet dispenser with drip tray 8 faucets	Included
BB103730-08	Underbar 30" cabinet dispenser with drip tray 8 faucets air cooled	Included
BB103730-08CK	Underbar 30" cabinet dispenser with drip tray 8 faucets	Included
BB103740-10	Underbar 40" cabinet dispenser with drip tray 10 faucets air cooled	Included
BB103740-10CK	Underbar 40" cabinet dispenser with drip tray 10 faucets	Included
BB103740-12	Underbar 40" cabinet dispenser with drip tray 12 faucets air cooled	Included
BB103740-12CK	Underbar 40" cabinet dispenser with drip tray 12 faucets	Included
BB103775-06CK	Kronos 18" dispenser drip tray 6 faucets	Included
BB103775-08CK	Kronos 24" dispenser drip tray 8 faucets	Included
BB103775-10CK	Kronos 30" dispenser drip tray 10 faucets	Included
BB103775-12CK	Kronos 36" dispenser drip tray 12 faucets	Included
BB103780-06CK	Kronos 18" dispenser drip tray and glass rinser 6 faucets	Included
BB103780-08CK	Kronos 24" dispenser drip tray and glass rinser 8 faucets	Included
BB103780-10CK	Kronos 30" dispenser drip tray and glass rinser 10 faucets	Included
BB103780-12CK	Kronos 36" dispenser drip tray and glass rinser 12 faucets	Included
WMD15-2G	Wall mount dispenser 15"W stainless finish 2 faucets	Included
WMD15-3G	Wall mount dispenser 15"W stainless finish 3 faucets	Included
WMD15-4G	Wall mount dispenser 15"W stainless finish 4 faucets	Included
WMD24-5G	Wall mount dispenser 24"W stainless finish 5 faucets	Included
WMD24-6G	Wall mount dispenser 24"W stainless finish 6 faucets	Included
WMD30-8G	Wall mount dispenser 30"W stainless finish 8 faucets	Included
WMD36-10G	Wall mount dispenser 36"W stainless finish 10 faucets	Included
WMD48-12G	Wall mount dispenser 48"W stainless finish 12 faucets	Included



Space Mizer



Underbar cabinet



Kronos



Kronos with rinser



## Wine Dispensers

All wine dispenser are made with 304 stainless steel shanks to maintain the wines' fine aroma and flavor. This quality assurance will provide you the peace of mind knowing that your best vintages will be delivered to the tap, as if it was from the barrel. Faucets and handles are not included.

Part Number	Faucets	Description	Drip Tray
WW107091CC*	1	Sexy tower 1 faucet chrome ETLs approved	10"
WW107092CC*	2	Sexy tower 2 faucet chrome ETLs approved	10"
WW107093CC*	3	Sexy tower 3 faucet chrome ETLs approved	15"
WW107106CC*	3	Panther tower 3 faucet chrome	15"
WW107111CC*	4	Panther tower 4 faucet chrome	15"
WW107121CC*	1	Lucky tower 1 faucet chrome ETLs approved	10"
WW107122CC*	2	Lucky tower 2 faucet chrome ETLs approved	10"
WW107123CC*	3	Lucky tower 3 faucet chrome ETLs approved	15"
WW107140CC*	1	Mongoose 1 faucet chrome	10"
WW107150CC*	2	Mongoose 2 faucet chrome	10"
WW107160CC*	3	Mongoose 3 faucet chrome	15"
WW107373CC*	3	Mini mushroom tower 3 faucet chrome	14 x 8" cutout
WW107374CC*	4	Mini mushroom tower 4 faucet chrome	14 x 8" cutout
WW107375CC*	5	Mini mushroom tower 5 faucet chrome	14 x 8" cutout
WW101421CC*	1	4" diameter column tower 1 faucet polished SS	14 x 8" cutout
WW101422CC*	2	4" diameter column tower 2 faucet polished SS	14 x 8" cutout
WW101423CC*	3	4" diameter column tower 3 faucet polished SS	14 x 8" cutout
WW101424CC*	4	4" diameter column tower 4 faucet polished SS	14 x 8" cutout
WW103121CC	1	3" Cylinder tower 1 faucet SS with SS clamp-on bracket & drip tray	6"
WW103122CC	2	3" Cylinder tower 2 faucet SS with SS clamp-on bracket & drip tray	10"
WW103614A-03	3	Underbar 13" Space-Mizer dispenser 3 faucets	15"
WW103614A-04	4	Underbar 13" Space-Mizer dispenser 4 faucets	15"
WW103620A-05	5	Underbar 20" Space-Mizer dispenser 5 faucets	20"
WW103620A-06	6	Underbar 20" Space-Mizer dispenser 6 faucets	20"
WW103626A-08	8	Underbar 26" Space-Mizer dispenser 8 faucets	24"
WW103632A-10	10	Underbar 32" Space-Mizer dispenser 10 faucets	30"
WW103638A-12	12	Underbar 38" Space-Mizer dispenser 12 faucets	36"

\*These towers are available as air cooled, replace CC with CA at the end of the part number(s).



## Wine Dispensing System Components

Part Number	Description
BB100992SS	TOF "D" coupler with 304SS probe
BB100997SS	TOF "S" coupler with 304SS probe
BB101004B-TS	TOF key keg coupler with 304SS probe
MP550035	Vitop Bag-In-Box connector
BB900217-W	Vin Service HE60 wine flash cooler 4 product lines (6m 6m 10m 7m) 115V 60L/hr, ETL listed



**See page 45 for Dual Core Wine Trunk Line**

## Faucets



BB101237 BB101236HD BB101239 BB101239HD BB101221C BB101252/CFP1 CFP7 BB101253/CFP5 BB101232  
19-0510 19-0511 BB101225 SF2003 BB101254 BB101254-G BB101212-SS BB101214-SS Custom branded faucet

Part #	Description
19-0510	Lancer Highlight 304SS quick disconnect tap with Fatlock shank & handle
19-0511	Lancer Highlight quick disconnect faucet only
BB101200-SS	TOF 304SS Euro faucet US threads
BB101202-SS	TOF 304SS Euro faucet w flow control US threads
BB101233	TOF Euro faucet gold plated w SS nozzle US threads
BB101234	TOF Euro faucet chrome plated w SS nozzle US threads
BB101221C	TOF Euro chrome flow cntl faucet w SS nozzle Euro shank
BB101221G	TOF Euro gold flow cntl faucet w SS nozzle Euro shank
BB101223	TOF Euro Spherix chrome faucet w SS nozzle US threads
BB101225	TOF Euro Spherix chrome ball valve faucet w SS nozzle Euro shank, 1/2" thread
BB101212-SS	Perlick 630SS (304SS) faucet for beer, wine, cider, water, fountain, coffee, US threads
BB101214-SS	Perlick 650SS (304SS) flow cntl faucet for beer, wine, cider, water, fountain, coffee, US threads
BB101228	Euro 316SS Celli faucet for beer, wine, cider, water, fountain, coffee, US threads
BB101231	Euro 304SS QUIX flow control faucet for beer, wine, cider, water, fountain, coffee, 50 psi, Euro shank
BB101232	Euro 304SS QUIX faucet for beer, wine, cider, water, fountain, coffee US threads
BB101198	Euro 316LSS FLUX flow control faucet for beer, wine, cider, water, fountain, coffee, 90 psi, Euro shank
BB101254	Euro Stout faucet polished 304SS for beer or coffee US threads
BB101254-G	Euro Stout faucet gold plated 304SS for beer or coffee US threads
BB101236	Burgundy plastic wine faucet with chrome nozzle
BB101236HD	Burgundy wine faucet w chrome nozzle & chrome tap handle
BB101237	Black plastic faucet with chrome nozzle
BB101237HD	Black faucet with chrome nozzle & chrome tap handle
BB101239	White plastic wine faucet with chrome nozzle
BB101239HD	White wine faucet w chrome nozzle & chrome tap handle
BB101250	Chrome plated American faucet with SS lever
BB101252	Chrome plated American faucet with brass lever

Part #	Description
BB101246	304SS American faucet for beer, wine, cider, water, fountain, coffee
BB101247	304SS American faucet with PVD finish for beer, wine, cider, water, fountain or coffee
BB101248	303SS standard beer faucet thread 3/8"-16 UNC, not recommended for wine or cider
BB101249	Gold plated American faucet with brass lever
BB101251	Polished brass American faucet w stainless steel lever
BB101253	Polished brass American faucet with brass lever
BF1001	Beer faucet chrome plated brass lever
BF1001SC	Beer faucet chrome plated brass lever self closing
BF1002	Beer faucet chrome plated SS lever
BF1002SC	Beer faucet chrome plated SS lever self closing
BF1002SC-SS	Beer faucet 304SS body 303SS lever self closing
BF1002SS	Beer faucet 304SS body 303SS lever
BF1003	Beer faucet brass with gold PVD finish brass lever
BF1004	Beer faucet brass with gold PVD finish SS lever
SF2003	Stout beer, wine, cider, coffee, or kombucha faucet, polished 304SS
SF2004	Stout beer, wine, cider, coffee, or kombucha faucet, 304SS with gold PVD finish
5702625	Stout beer tap, stainless steel
CUSTFAUCET	Custom branded faucet
CFP1	Chrome plated American faucet with brass lever
CFP2	Chrome plated American faucet with SS lever
CFP5	Polished brass American faucet with brass lever
CFP6	Polished brass American faucet with SS lever
CFP7	Self closing American faucet chrome with brass lever
CFS304	304SS American faucet
C256	304SS American faucet, PVD coated tarnish free

## Beer Dispensing Bar Guns



Part Number	Description
C210	Hand beer dispensing gun, chrome finish

## Unbranded Faucet Handles

See page 26 for custom graphics lead times



Part #	Description
X919171	White Victory with chrome base
X919172	Black Victory with chrome base
X920210B-C	Black Round Conical handle with chrome fittings
X920210B-G	Black Round Conical handle with gold fittings
X920210W-C	White Round Conical handle with chrome fittings
X920210W-G	White Round Conical handle with gold fittings
X920214B-C	Black Paddle Conical handle with chrome fittings
X920214B-G	Black Paddle Conical handle with gold fittings
X920214W-C	White Paddle Conical handle with chrome fittings
X920214W-G	White Paddle Conical handle with gold fittings
X920202-OS	Black Large Pub chrome oval shield chrome fittings
X920203-OS	White Large Pub gold oval shield gold fittings
X920204-OS	Black Large Pub gold oval shield gold fittings
X920201-OS	White Large Pub chrome oval shield chrome fittings
X920201-RT	White Large Pub chrome round top chrome base
X920202-RT	Black Large Pub chrome round top chrome base
X920201	White Large Pub handle with chrome fittings
X920202	Black Large Pub handle with chrome fittings
X920203	White Large Pub handle with gold fittings
X920204	Black Large Pub handle with gold fittings
X920101	White Small Pub handle with chrome fittings
X920102	Black Small Pub handle with chrome fittings
X920103	White Small Pub handle with gold fittings
X920104	Black Small Pub handle with gold fittings

Part #	Description
X898799W-C	White Tobie handle with chrome fitting
X898799B-C	Black Tobie handle with chrome fitting
X898798W-G	White Tobie handle with gold fitting
X898798B-G	Black Tobie handle with gold fitting
X919181	White Magnum with chrome base
X919182	Black Magnum with chrome base
X919011	White Outrigger with chrome base
X919012	Black Outrigger with chrome base
X919031	White T-Bird with chrome base
X919032	White T-Bird with chrome base
X919032	Black T-Bird with chrome base
X919161	White Torch with chrome base
X919162	Black Torch with chrome base
X919021	White Trap-Z with chrome base
X919022	Black Trap-Z with chrome base
X919001	White Baton with chrome base
X919002	Black Baton with chrome base
X919051	White Shotgun 2.0 with chrome base
X919052	Black Shotgun 2.0 with chrome base
X919053	Blue Shotgun 2.0 with chrome base
X919054	Red Shotgun 2.0 with chrome base
X919055	Green Shotgun 2.0 with chrome base
X100301B	Ergo custom branded black handle 1 print
X100302B	Ergo custom branded black handle 2 print
X100305C	Ergo custom branded chrome handle 1 print
X100306C	Ergo custom branded chrome handle 2 print



## Unbranded Faucet Handles

See page 26 for custom graphics lead times



Part #	Description
BB100301-B	European black plastic 4" tap handle
BB100301-C	European chrome plastic 4" tap handle
C190	Beer faucet extended handle standard chrome plated brass
C185SS	Beer faucet handle 2-1/2" stainless steel
BB101255	Plastic tap handle 2-3/4" black
C186	Plastic tap handle 2-1/2" black
BB101258-B	Plastic tap handle 2-1/2" black
BB101260	Chrome metal tap handle 2-1/2"
BB101260-XL	Lightweight chrome metal tap handle 2-1/2"
BB101259-B	Plastic tap handle 3-1/4" clear with black base
BB101261-BLK	Plastic tap handle 3-1/4" black
BB101261-CHR	Plastic tap handle 3-1/4" chrome
BB101261-GLD	Plastic tap handle 3-1/4" gold

Part #	Description
CPTA57B	Ceramic handle shielded pub black, specify chrome or brass
CPTA57R	Ceramic handle shielded pub red, specify chrome or brass
CPTA57W	Ceramic handle shielded pub white, specify chrome or brass
CPTA113B	Ceramic handle twirled black, specify chrome or brass
CPTA113R	Ceramic handle twirled red, specify chrome or brass
CPTA113W	Ceramic handle twirled white, specify chrome or brass
CPTA100B	Ceramic handle rectangular black, specify chrome or brass
CPTA100R	Ceramic handle rectangular red, specify chrome or brass
CPTA100W	Ceramic handle rectangular white, specify chrome or brass
CPTA5B	Ceramic knob oval black, specify chrome or brass
CPTA5R	Ceramic knob oval red, specify chrome or brass
CPTA5W	Ceramic knob oval white, specify chrome or brass
CPE93.8	Beer faucet round black plastic knob
C284	Brass insert for plastic knobs
C241	Finial standard chrome tap handle
C242	Finial standard polished brass tap handle
C128	2" faucet handle extension
C528	1" faucet handle extension
C243	Ferrule chrome for beer tap handle
C244	Ferrule polished brass for beer tap handle
C686	Ferrule large chrome plated brass for beer faucet
C129	Faucet handle angler/tilter chrome plated brass for vertical position handles
C829	Faucet handle angler/tilter polished brass for vertical position handles

## Custom Branded Faucet Handles



All faucet handles on page 24 can be custom branded. Add -BR to the end of the part number for Tobie, Conical (paddle or round), or Oval Shield (OS) Pub handles. Add -UV to the end of the part number for all other handles. There are quantity price breaks at 5, 10, 25, 50 and 100. Call for pricing and artwork specifications.

Custom Graphics	Qty	Lead Time
Tap Handles, UV Printed	1-19	7 days
	20-49	10 days
	50-99	12 days
	100+	Confirmation
Medallions, 60, 80 & 82mm	1-199	7 days
	200-499	10 days
	500 +	Confirmation
Shield Teardrop Plaques	1-99	7 days
	100+	Confirmation

## Custom Branded Medallions



Part #	Description
X900206	Custom branded round fish-eye medallion 60mm diameter with 2 small tabs
X900210	Custom branded round fish-eye medallion 80mm diameter with 4 small tabs
X900215	Custom branded Shield tower medallion
X900220	Custom branded round fish-eye medallion 82mm diameter
X900500	Custom branded lit dome fits 80 and 82mm LED medallion holders



Shield tower

Beer Systems, Bar Equipment

## Unbranded Medallions

See page 26 for custom graphics lead times



Part #	Description
BB501200C	Chrome nickel 3 way round medallion holder assy
BB501220C	Chrome nickel 4 way round medallion holder assy
BB501113C	Chrome oval horizontal extra tall medallion holder
BB501110C	Chrome oval horizontal short medallion holder
BB501112C	Chrome oval horizontal tall medallion holder
BB501108C	Chrome oval vertical extra tall medallion holder
BB501100	Chrome oval vertical medallion holder w angled support
BB501105C	Chrome oval vertical short medallion holder
BB501107C	Chrome oval vertical tall medallion holder
BB501131C	Chrome round extra tall medallion holder
BB501320C	Chrome round faucet mount medallion holder
BB501101C	Chrome round medallion holder with angled support
BB501170	Chrome round medallion holder with screw for face mount applications
BB501125C	Chrome round short medallion holder
BB501130C	Chrome round tall medallion holder
BB501200G	Gold nickel 3 way round medallion holder assembly
BB501113G	Gold oval horizontal extra tall medallion holder
BB501110G	Gold oval horizontal short medallion holder
BB501108G	Gold oval vertical extra tall medallion holder
BB501105G	Gold oval vertical short medallion holder
BB501107G	Gold oval vertical tall medallion holder
BB501131G	Gold round extra tall medallion holder
BB501101G	Gold round medallion holder with angled support
BB501125G	Gold round short medallion holder
BB501130G	Gold round tall medallion holder

Part #	Description
BB501200B	Black nickel 3 way round medallion holder assembly
BB501220B	Black nickel 4 way round medallion holder assembly
BB501113B	Black nickel oval horizontal extra tall medallion holder
BB501110B	Black nickel oval horizontal short medallion holder
BB501108B	Black nickel oval vertical extra tall medallion holder
BB501105B	Black nickel oval vertical short medallion holder
BB501107B	Black nickel oval vertical tall medallion holder
BB501131B	Black nickel round extra tall medallion holder
BB501125B	Black nickel round short medallion holder
BB501130B	Black nickel round tall medallion holder
BB103440-BR	3" diameter brass tower cap w 1-side medallion holder
BB103440-C	3" diameter chrome tower cap w 1-side medallion holder
BB103442-BR	3" diameter brass tower cap w 2-side medallion holder
BB103442-C	3" diameter chrome tower cap w 2-side medallion holder
BB103470-C	3" dia, chrome tower cap w 2-side LED medallion holder
X900150	82mm diameter white ceramic medallion
BB502191-PP	Plug & Play chrome female connector
BB502183PP	Double chrome plug & play LED medallion holder
BB502181PP	Single chrome plug & play LED medallion holder
BB501999	Transformer for LED medallion holders
BB502186PP	Triple chrome plug & play LED medallion holder

## Shanks



Part #	Finish	Size"	Description
01-2921	SS	2-1/8	Tower/wall shank, 3/16" bore, plastic flange
01-2922	SS	3-1/8	Tower/wall shank, 3/16" bore, plastic flange
01-2923	SS	4-1/8	Tower/wall shank, 3/16" bore, plastic flange
01-2924	SS	5-1/8	Tower/wall shank, 3/16" bore, plastic flange
01-2925	SS	6-1/8	Tower/wall shank, 3/16" bore, plastic flange
01-2926	SS	8-1/8	Tower/wall shank, 3/16" bore, plastic flange
01-2927	SS	10-1/8	Tower/wall shank, 3/16" bore, plastic flange
01-2928	SS	12-1/8	Tower/wall shank, 3/16" bore, plastic flange
01-2935	SS	2-1/8	Tower/wall shank, 1/4" bore, plastic flange
01-2936	SS	3-1/8	Tower/wall shank, 1/4" bore, plastic flange
01-2937	SS	4-1/8	Tower/wall shank, 1/4" bore, plastic flange
01-2938	SS	5-1/8	Tower/wall shank, 1/4" bore, plastic flange
01-2939	SS	6-1/8	Tower/wall shank, 1/4" bore, plastic flange
01-2940	SS	8-1/8	Tower/wall shank, 1/4" bore, plastic flange
01-2941	SS	10-1/8	Tower/wall shank, 1/4" bore, plastic flange
01-2942	SS	12-1/8	Tower/wall shank, 1/4" bore, plastic flange
01-2943	Chrome	1-3/4	Nipple shank, 3/16" bore, 1/4" barb, plastic flange
01-2944	Chrome	2-3/4	Nipple shank, 3/16" bore, 1/4" barb, plastic flange
01-2945	Chrome	3-3/4	Nipple shank, 3/16" bore, 1/4" barb, plastic flange
01-2946	Chrome	4-3/4	Nipple shank, 3/16" bore, 1/4" barb, plastic flange
01-2947	Chrome	5-3/4	Nipple shank, 3/16" bore, 1/4" barb, plastic flange
01-2948	Chrome	1-3/4	Nipple shank, 1/4" bore, 1/4" barb, plastic flange
01-2949	Chrome	2-3/4	Nipple shank, 1/4" bore, 1/4" barb, plastic flange
01-2950	Chrome	3-3/4	Nipple shank, 1/4" bore, 1/4" barb, plastic flange
01-2951	Chrome	4-3/4	Nipple shank, 1/4" bore, 1/4" barb, plastic flange
01-2952	Chrome	5-3/4	Nipple shank, 1/4" bore, 1/4" barb, plastic flange
C300	Chrome	1-3/4	Nipple shank, 3/16" bore, SS flange
CPC28	Chrome	1-7/8	Elbow nipple shank, 3/16" bore, 304SS elbow soldered to shank
CPC32	Chrome	1-7/8	Elbow nipple shank, 1/4" bore, 304SS elbow soldered to shank
CPC29	Pol. brass	1-7/8	Elbow nipple shank, 3/16" bore, 304SS elbow soldered to shank
BE-DF2-3		2-1/4	Dual shank 3/16" bore
BE-DF4-3		4-1/4	Dual shank 3/16" bore
BE-DF6-3		6-1/4	Dual shank 3/16" bore
BE-DF8-3		8-1/4	Dual shank 3/16" bore
BE-DF10-3		10-1/4	Dual shank 3/16" bore
BE-DF12-3		12-1/4	Dual shank 3/16" bore
C311		1-5/8	Thread-in shank - replacement for Perlick towers
C125		24	Tower/wall extra long 24" shank assembly 3/16" bore



C125

Diagram for C125 extra long shank assembly

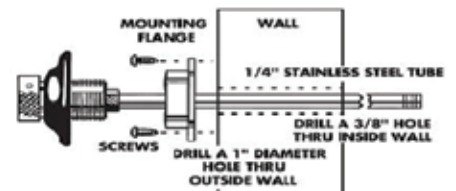

## Shanks



C300A



CPC300.10



CPC28.2



CPC28.3



CPC28.4

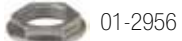

01-2956



CPC300.12  
4330



CPC300.11  
4328



C328.1



C126

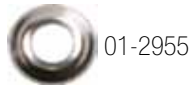

01-2955



01-2954



C228

Part #	Finish	Size"	Description
C300A	Chrome	1-3/4	C300 shank only, no parts, 3/16" bore SS flange, nipple adds 1/2"
CPC300.10	Chrome	1	1" shank extension - extends faucet out by 1"
CPC300.20	Pol. brass	1	1" shank extension - extends faucet out by 1"
CPC300.30	Chrome	3/4	3/4" shank extension - extends faucet out by 1"
CPC28.2	Brass		Lock nut for column shank (replacement part)
CPC28.3	Plastic	3	Curved plastic flange -3" diameter
CPC28.4			Metal grooved lock washer
01-2956			Shank flanged lock nut (replacement part)
CPC28.3			Shank sleeve (replacement part)
CPC300.12			Shank sleeve (replacement part)
4330	NP		Sleeve, nickel plated
CPC300.11			Shank snap ring (replacement part)
4328			Lock ring for beer shank
CPC28.1	Chrome		Flange for 3" column shank
CPC28L.1	Chrome		Flange for 3" column shank, long size
CPC29.1	Brass		Flange for 3" column shank polished brass
CPC48.1	Chrome		Flange for 4" column shank
C126	Brass		Locking flange for wall shank assy
01-2955	SS		Stainless steel flange
01-2954			Shank plastic flange
C228	Brass		Cold block, fits 7/8" shank

## Faucet Parts and Accessories

Part #	Description
4332	Coupling nut with knurl for standard faucet
4350	Spanner wrench no grip
4350S	Spanner wrench with black grip
70104	Ball washer
70105	Knob lever collar, chrome plated
70107	Faucet O-ring (body gasket)
70108	Friction washer
70110	Valve shaft seat
70380	Spanner wrench with red handle
01-2953	Faucet coupling nut
4350S	Spanner wrench with black grip
70103-04	Shaft assembly with seat for faucet
70166-01	Friction bonnet
BB101254-25	Stout faucet creamer plate .25mm
BB101254-BD	Stout faucet diaphragm
BB101725	Euro faucet wrench
BB101727	6 in 1 Perlick combination wrench
BB700405	Metal slide-on faucet lock
BB700415	Perlick faucet lock
BB700420	Stout faucet lock - padlock not included
C109	Adapter to connect faucet and quick disconnect
C119	Chrome faucet coupling nut
C130	Faucet plug seals shank when faucet is removed
CP101550	Beer faucet spout plug
C182	Beer faucet spout plug, box of 100
CP101555	Beer faucet spout plug for European faucets w SS nozzles

Part #	Description
CFP1.20	Faucet shaft assembly, chrome plated brass
CFS304.20	Faucet shaft assembly, 304SS
CFP1.34	Faucet body back gasket
CFP1.40	Faucet friction washer
CFP1.50	Faucet friction ring
C226	Beer faucet spout extension
C227	Beer faucet SS spout extension converts US faucet to European faucet
C230	Stainless steel faucet lever
CFL39	Wrap around faucet lock with 2 alike keys
C245	Brass faucet lever
CFP67.04	Stout faucet sliding cap
CFP67.05	Stout faucet O-ring 17 x 25 (sliding cap)
CFP67.14	Stout faucet O-ring 10 x 2 (for nozzle)
CFP67.15	Stout faucet jet disk (restrictor plate)
CFP67.16	Stout faucet regulation core
C284	Brass insert for plastic knobs
C419	Faucet coupling nut, polished brass
CB45	Faucet hygiene plug
C696	Tap handle bolt 1-1/2" long
D4740-W	Wrench set for draft towers, side and center access, 1-1/16 x 1"
82-4373	Hilight faucet O-ring kit



## Drip Trays

### Part Number Description

#### Lancer Flooded Tower Stainless Steel Drip Trays - resin filled

23-1586	Resin filled drip tray 16.19" x 14" Outside bevel: 18.66" x 16.45"
23-1581	Resin filled drip tray 21.89" x 14" Outside bevel: 24.38" x 16.45"
23-1582	Resin filled drip tray 29.77" x 14" Outside bevel: 32.25" x 16.45"
23-1585	Resin filled drip tray 35.67" x 14" Outside bevel: 38.16" x 16.45"
23-1587	Resin filled drip tray 43.55" x 14" Outside bevel: 46.03" x 16.45"
23-1600	Resin filled drip tray 55.36" x 14" Outside bevel: 57.83" x 16.45"
23-1601	Resin filled drip tray 71.89" x 14" Outside bevel: 74.38" x 16.45"

#### Stainless Steel European Drip Trays - with drain, no tower hole

BB700060	Euro drip tray 15.75" L x 15.75" D
BB700061	Euro drip tray 19.75" L x 15.75" D
BB700063	Euro drip tray 27.5" L x 15.75" D

#### Stainless Steel European Drip Trays - with drain, with tower hole

BB700060-1	Euro drip tray 1 tower hole 15.75" x 1-3/16" x 15.75"
BB700060-2	Euro drip tray 2 tower holes 15.75" x 1-3/16" x 15.75"
BB700061-1	Euro drip tray 1 tower hole 19.75" x 1-3/16" x 15.75"
BB700061-2	Euro drip tray 2 tower holes 19.75" x 1-3/16" x 15.75"
BB700061-3	Euro drip tray 3 tower holes 19.75" x 1-3/16" x 15.75"
BB700063-1	Euro drip tray 1 tower hole 27.5" x 1-3/16" x 15.75"
BB700063-2	Euro drip tray 2 tower holes 27.5" x 1-3/16" x 15.75"
BB700063-3	Euro drip tray 3 tower holes 27.5" x 1-3/16" x 15.75"

#### Stainless Steel Countertop Drip Trays - 5.5" depth

30-11592	Surface mount drip tray 8" L x 5.5" D x .75" H
30-11593	Surface mount drip tray 15" L x 5.5" D x .75" H
30-11594	Surface mount drip tray 24" L x 5.5" D x .75" H
30-11595	Surface mount drip tray 30" L x 5.5" D x .75" H
30-11596	Surface mount drip tray 36" L x 5.5" D x .75" H
30-11597	Surface mount drip tray 48" L x 5.5" D x .75" H
30-11598	Surface mount drip tray 60" L x 5.5" D x .75" H

#### Stainless Steel Countertop Drip Trays - 8" depth

30-11599	Surface mount drip tray 8" L x 8" D x .75" H
30-11600	Surface mount drip tray 15" L x 8" D x .75" H
30-11601	Surface mount drip tray 24" L x 8" D x .75" H
30-11602	Surface mount drip tray 30" L x 8" D x .75" H
30-11603	Surface mount drip tray 36" L x 8" D x .75" H
30-11604	Surface mount drip tray 48" L x 8" D x .75" H
30-11605	Surface mount drip tray 60" L x 8" D x .75" H

#### Clamp-on Drip Trays

BB701694	Chrome plated bracket w drip tray, 5 holes for 1 faucet 3" column tower
BB701695	Chrome plated bracket with drip tray for 1 faucet Euro tower
BB701701C	Chrome plated bracket with 10" drip tray for 2/3 faucet Euro tower
BB701702C	Chrome plated bracket w 10" drip tray, 5 holes for 2/3 faucet 3" column tower
30-11608	Clamp on tower base and drip tray



Resin filled drip tray

Resin fill provides rigidity for towers mounted directly to the drip tray, and prevents crushing when the tower is mounted through the counter and tightened down. Resin fill also reduces unsanitary buildup under the drip tray. The drip edge keeps beer in the drip tray and off the counter. Drip trays have center drains and use 3/4" drain tubing. Satin finish is standard. High polish and custom sizes are available on request.



Euro drip tray

European drip trays can be ordered with 1 to 4 tower holes, depending on the length of the tray.



Countertop drip tray



30-11608



BB701695

Beer tower and faucets not included

## Drip Trays

Part Number	Description
<b>Stainless Steel Countertop Drip Trays with Plastic Insert</b>	
BB700800	Stainless steel drip tray with plastic grid no drain 5-3/8" x 3/4" x 10-3/8"
BB700810	Stainless steel drip tray with plastic grid no drain 5-3/8" x 3/4" x 15"
BB700815	Stainless steel drip tray with plastic grid no drain 5-3/8" x 3/4" x 20"
BB700820	Stainless steel drip tray with plastic grid no drain 5-3/8" x 3/4" x 24"
BB701900	Stainless steel drip tray with plastic grid with drain 5-3/8" x 3/4" x 10-3/8"
BB701910	Stainless steel drip tray with plastic grid with drain 5-3/8" x 3/4" x 15"
BB701915	Stainless steel drip tray with plastic grid with drain 5-3/8" x 3/4" x 20"
BB701920	Stainless steel drip tray with plastic grid with drain 5-3/8" x 3/4" x 24"
<b>Brass Countertop Drip Trays with Plastic Insert</b>	
BB700800B	Brass drip tray with black plastic grid no drain 5-3/8" x 3/4" x 8"
BB700810B	Brass drip tray with black plastic grid no drain 5-3/8" x 3/4" x 15"
BB701900-BR-P	Brass drip tray with black plastic grid with drain 5-3/8" x 3/4" x 8"
BB701912-BR-P	Brass drip tray with black plastic grid with drain 5-3/8" x 3/4" x 15"
BB701920-BR-P	Brass drip tray with black plastic grid with drain 5-3/8" x 3/4" x 24"
<b>Stainless Steel Countertop Drip Trays with Stainless Steel Insert</b>	
BB700795	Stainless steel drip tray with SS insert no drain 5-3/8" x 3/4" x 5"
BB700802	Stainless steel drip tray with SS insert no drain 5-3/8" x 3/4" x 10-3/8"
BB700812	Stainless steel drip tray with SS insert no drain 5-3/8" x 3/4" x 15"
BB700817	Stainless steel drip tray with SS insert no drain 5-3/8" x 3/4" x 20"
BB700822	Stainless steel drip tray with SS insert no drain 5-3/8" x 3/4" x 24"
BB700832	Stainless steel drip tray with SS insert no drain 5-3/8" x 3/4" x 30"
BB701902	Stainless steel drip tray with SS insert with drain 5-3/8" x 3/4" x 10-3/8"
BB701908	Stainless steel drip tray with SS insert with drain 5-3/8" x 3/4" x 12"
BB701912	Stainless steel drip tray with SS insert with drain 5-3/8" x 3/4" x 15"
BB701917	Stainless steel drip tray with SS insert with drain 5-3/8" x 3/4" x 20"
BB701922	Stainless steel drip tray with SS insert with drain 5-3/8" x 3/4" x 24"
BB701932	Stainless steel drip tray with SS insert with drain 5-3/8" x 3/4" x 30-1/4"
BB701937	Stainless steel drip tray with SS insert with drain 5-3/8" x 3/4" x 33"
BB701942	Stainless steel drip tray with SS insert with drain 5-3/8" x 3/4" x 36"
BB701947	Stainless steel drip tray with SS insert with drain 5-3/8" x 3/4" x 39"
BB701952	Stainless steel drip tray with SS insert with drain 5-3/8" x 3/4" x 45-1/4"
BB701962	Stainless steel drip tray with SS insert with drain 5-3/8" x 3/4" x 51"
BB701967	Stainless steel drip tray with SS insert with drain 5-3/8" x 3/4" x 57"
BB701312	Stainless steel drip tray with SS insert with drain 7" x 7/8" x 12"
BB701316	Stainless steel drip tray with SS insert with drain 7" x 7/8" x 16"
BB701320	Stainless steel drip tray with SS insert with drain 7" x 7/8" x 20"
BB701324	Stainless steel drip tray with SS insert with drain 7" x 7/8" x 24"
BB701330	Stainless steel drip tray with SS insert with drain 7" x 7/8" x 30"
BB701336	Stainless steel drip tray with SS insert with drain 7" x 7/8" x 36"
BB701339	Stainless steel drip tray with SS insert with drain 7" x 7/8" x 39"
BB701345	Stainless steel drip tray with SS insert with drain 7" x 7/8" x 45"
BB701351	Stainless steel drip tray with SS insert with drain 7" x 7/8" x 51"
BB701172	Stainless steel drip tray with SS insert with drain 8" x 3/4" x 16"
BB701174	Stainless steel drip tray with SS insert with drain 8" x 3/4" x 20"
BB701175	Stainless steel drip tray with SS insert with drain 8" x 3/4" x 24"
BB701177	Stainless steel drip tray with SS insert with drain 8" x 3/4" x 30"
BB701178	Stainless steel drip tray with SS insert with drain 8" x 3/4" x 33"
BB701180	Stainless steel drip tray with SS insert with drain 8" x 3/4" x 39"
BB701181	Stainless steel drip tray with SS insert with drain 8" x 3/4" x 45"



Stainless drip tray with plastic insert, no drain

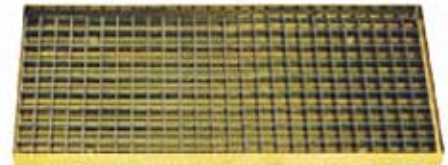

Brass drip tray with plastic insert, no drain



Stainless drip tray with stainless insert



## Drip Trays

Part Number	Description
-------------	-------------

### Stainless Steel European Drip Trays - with rinser, no tower hole

BB700070	Euro rinser drip tray 15.75" L x 15.75" D
BB700071	Euro rinser drip tray 19.75" L x 15.75" D
BB700073	Euro rinser drip tray 27.5" L x 15.75" D



Euro rinser drip tray

### Stainless Steel European Drip Trays - with rinser, with tower hole(s)

BB700070-1	Euro rinser drip tray 1 tower hole 15.75" x 1-3/16" x 15.75"
BB700070-2	Euro rinser drip tray 2 tower holes 15.75" x 1-3/16" x 15.75"
BB700071-1	Euro rinser drip tray 1 tower hole 19.75" x 1-3/16" x 15.75"
BB700071-2	Euro rinser drip tray 2 tower holes 19.75" x 1-3/16" x 15.75"
BB700073-1	Euro rinser drip tray 1 tower hole 27.5" x 1-3/16" x 15.75"
BB700073-3	Euro rinser drip tray 3 tower holes 27.5" x 1-3/16" x 15.75"
BB700073-4	Euro rinser drip tray 4 tower holes 27.5" x 1-3/16" x 15.75"



Cut-out drip tray with rinser

### Stainless Steel Cut-out Drip Trays - with rinser

BB702110	4-1/2" cutout radius, side rinser, 7-1/2" x 7/8" x 15"
BB702125	6-1/4" cutout radius, side rinser, 9" x 7/8" x 18"
BB702150	8-1/4" cutout radius, side rinser, 10" x 7/8" x 19.75"
BB702163	6" cutout radius, side rinser, 8" x 7/8" x 24"
BB702180	6" cutout radius, side rinser 8" x 7/8" x 34"
BB702160	7-1/4" cutout radius, side rinser, 11" x 7/8" x 22"
BB702628	Cut-out corners, side rinser, 8" x 7/8" x 24"
BB702634	Cut-out corners, side rinser, 8" x 7/8" x 34"
BB702646	Cut-out corners, side rinser, 8" x 7/8" x 46"



Surface mount drip tray with cut-out corners and rinser (rinser not shown)

### Stainless Steel Countertop Drip Trays - with rinser

BB702408	Surface mount drip tray with center rinser 8" x 7/8" x 8"
BB702412	Surface mount drip tray with center rinser 7" x 7/8" x 12"
BB702416	Surface mount drip tray with center rinser 7" x 7/8" x 16"
BB702420	Surface mount drip tray with side rinser 7" x 7/8" x 20"
BB702424	Surface mount drip tray with side rinser 7" x 7/8" x 24"
BB702430	Surface mount drip tray with side rinser 7" x 7/8" x 30"
BB702436	Surface mount drip tray with side rinser 7" x 7/8" x 36"
BB702439	Surface mount drip tray with side rinser 7" x 7/8" x 39"
BB702445	Surface mount drip tray with side rinser 7" x 7/8" x 45"
BB702451	Surface mount drip tray with side rinser 7" x 7/8" x 51"
CDT66R	Surface mount rinser drip tray with rinser 6.5" x 6.5"



Surface mount drip tray with rinser



BB101177



82-4572



CDT66R

### Stainless Steel Undercountertop Drip Tray - with rinser

BB101177	Undercounter mount with glass rinser
82-4572	Heavy duty glass rinser assembly

### Rinser Assemblies and Replacement Parts

BB101174	Heavy duty glass rinser assembly (black plate)
BB101174-PLT	Plastic plate for BB101174
BB101175	Heavy duty glass rinser assembly (SS plate)
BB101175-PLT	Stainless steel plate for BB101175
BB101179	Glass rinser assembly (plastic star)
BB101179-STAR	Plastic star for BB101179
BB101178-MTL	Metal spray assembly with vinyl sleeves



BB101174



BB101174-PLT



BB101175



BB101175-PLT



BB101179



BB101179-STAR



BB101178-MTL

## Drip Trays

### Part Number Description

#### Stainless Steel Wall Mounted Drip Trays - with rinser

BB700115-04	Wall mt drip tray, ctr rinser, 4 holes, 8"D x 14"H x 12"L
BB700115-06	Wall mt drip tray, ctr rinser, 6 holes, 8"D x 14"H x 24"L
BB700115-08	Wall mt drip tray, ctr rinser, 8 holes, 8"D x 14"H x 32"L
BB700115-10	Wall mt drip tray, ctr rinser, 10 holes, 8"D x 14"H x 40"L
BB700115-12	Wall mt drip tray, ctr rinser, 12 holes, 8"D x 14"H x 48"L

#### Stainless Steel Wall Mt Growler Filler Drip Trays - with rinser

BB700138-02	Wall mt drip tray, growler filler, ctr rinser, 2 holes, 8"D x 22"H x 12"L
BB700138-03	Wall mt drip tray, growler filler, ctr rinser, 3 holes, 8"D x 22"H x 18"L
BB700138-04	Wall mt drip tray, growler filler, ctr rinser, 4 holes, 8"D x 22"H x 24"L
BB700138-05	Wall mt drip tray, growler filler, ctr rinser, 5 holes, 8"D x 22"H x 30"L
BB700138-06	Wall mt drip tray, growler filler, ctr rinser, 6 holes, 8"D x 22"H x 36"L
BB700138-07	Wall mt drip tray, growler filler, ctr rinser, 7 holes, 8"D x 22"H x 42"L
BB700138-08	Wall mt drip tray, growler filler, ctr rinser, 8 holes, 8"D x 22"H x 48"L

#### Stainless Steel Wall Mounted Drip Trays

30-11586	8" L x 6.5" D x 14" H maximum 3 holes
30-11587	15" L x 6.5" D x 14" H maximum 5 holes
30-11588	24" L x 6.5" D x 14" H maximum 8 holes
30-11589	30" L x 6.5" D x 14" H maximum 10 holes
30-11590	36" L x 6.5" D x 14" H maximum 12 holes
30-11591	48" L x 6.5" D x 14" H maximum 15 holes
BB700051-0	8"W x 6-3/8"D x 14"H, with drain no faucet hole
BB700051-1	8"W x 6-3/8"D x 14"H, with drain 1 faucet hole
BB700051-2	8"W x 6-3/8"D x 14"H, with drain 2 faucet holes
BB700053-0	12"W x 6-3/8"D x 14"H, with drain no faucet hole
BB700053-1	12"W x 6-3/8"D x 14"H, with drain 1 faucet hole
BB700053-2	12"W x 6-3/8"D x 14"H, with drain 2 faucet holes
BB700053-3	12"W x 6-3/8"D x 14"H, with drain 3 faucet holes
BB700053-4	12"W x 6-3/8"D x 14"H, with drain 4 faucet holes
BB700055-4	16"W x 6-3/8"D x 14"H, with drain 4 faucet holes
BB700055-5	16"W x 6-3/8"D x 14"H, with drain 5 faucet holes
BB700056-6	24"W x 6-3/8"D x 14"H, with drain 6 faucet holes
BB700056-8	24"W x 6-3/8"D x 14"H, with drain 8 faucet holes
BB700057-08	30"W x 6-3/8"D x 14"H, with drain 8 faucet holes
BB700057-10	30"W x 6-3/8"D x 14"H, with drain 10 faucet holes
BB700059-14	48"W x 6-3/8"D x 14"H, with drain 14 faucet holes
BB700059-16	48"W x 6-3/8"D x 14"H, with drain 16 faucet holes
BB700048	5-5/8" x 5-5/8" x 1-1/4"H with drain
BB700049	5-5/8" x 5-5/8" x 1-1/4"H no drain
BB700050-06	6" x 4" x 3"H, no drain
BB700050-10	10" x 5" x 1-1/2"H, no drain
BB700051-JB	6" x 6" x 11"H, with drain 1 faucet hole



Wall mount drip tray with rinser  
Shanks and faucets not included



Wall mount drip tray  
Shanks and faucets not included



BB700048



BB700050-06

## Drip Trays

Part Number	Description
<b>Stainless Steel Cut-out Drip Trays</b>	
BB701005	4.5" cutout radius, no drain 7.5" x .88" x 15.5"
BB701110	4.5" cutout radius, with drain 7.5" x .88" x 15"
BB701020	6.25" cutout radius, no drain 9" x .88" x 18"
BB701125	6.25" cutout radius, with drain 9" x .88" x 18"
BB701061S	6.5" cutout radius, with drain 10" x .88" x 19.75"
BB701150	8.25" cutout radius, with drain 10" x 1" x 19.75"
BB701165	7.5" cutout radius, with drain 11" x .88" x 24"
BB701108	6.0" cutout radius, with drain 8" x .75" x 14"
BB701718	5.75" cutout radius, with drain 9" x .75" x 18"
BB701135	6.25" cutout radius, with drain 9" x .75" x 19"
BB701163	6" cutout radius, with drain 8" x 7/8" x 24"
BB701628	Cutout corners with drain 8" x 7/8" x 28"
BB701634	Cutout corners with drain 8" x 7/8" x 34"
BB701640	Cutout corners with drain 8" x 7/8" x 40"
BB701646	Cutout corners with drain 8" x 7/8" x 46"
<b>Brass Cut-out Drip Trays With Drain</b>	
BB701208	6" cutout radius, 8" x 3/4" x 14"
BB701235	6-1/4" cutout radius, 9" x 7/8" x 19"
BB701265	7-1/2" cutout radius, 11" x 7/8" x 24"

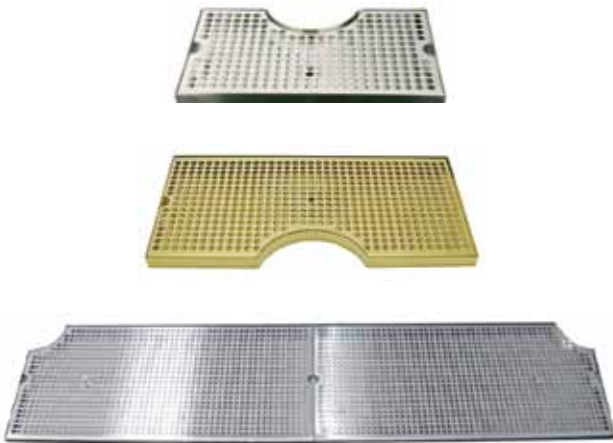

Cut-out drip trays

## Drain Fittings and Drip Tray Accessories

Part Number	Description
BB101180	Drain nut with 1/2" nipple
BB101184	Drain assembly for True Direct Draw Cabinets
BB101185	Drain flange adaptor with 1/2" angled spout
BB101186	4" Brass drain with lock nut and washer
BB101187	2" Brass drain with lock nut and washer
BB101188	1-1/8" Brass drain with lock nut and washer
C610	Std drain nipple and nut, thread 1/2" BSP
C958	Std drain assy, 3-1/2" long, drain thread 5/8" x 18
C959	Std drain assy, 6" long, drain thread 5/8" x 18
C141	Std drain assy, 8" long, drain thread 5/8" x 18
C954	Drain assembly, 2" long, 1/2" MPT
C955	Drain assembly, 4" long, 1/2" MPT
QD100633	JG 1/2 BSP x 3/8" tube water connection
3998290	1/4" Inline plastic barb shut-off
5740990	3/8" Inline plastic barb shut-off
6885190	1/2" Inline plastic barb shut-off
01752300C	Inline water reg, 50 psi, quick disconnect, no ports
01752302C	Inline water reg, 50 psi, QD, 3/8" hose barbs
01752320C	Inline water reg, 30 psi, quick disconnect, no ports
01752322C	Inline water reg, 30 psi, QD, 3/8" hose barbs



Drain nut and nipple



01752 inline water regulator



6885190



Drain assembly



Drain assembly MPT

[www.lancer-direct.fastcooler.com](http://www.lancer-direct.fastcooler.com)

## Your One-Stop Source for Walk-In Coolers!

This website has all the information you'll need to make an informed and intelligent decision when selecting a walk-in cooler:

- Buyer's Guide
- Online video and pdf Installation Guide
- *Cooler Connection*, the coolest blog in the Foodservice Industry!
- FAQ's
- E-mail link to ask specific questions
- Information about the manufacturer, U.S. Cooler
- Online purchasing 24-7

Here's a sample of what you'll find in our Buyer's Guide...

When making a decision which walk-in cooler or freezer to buy there are many things that must be considered. Our online Buyer's Guide will help you go through all these considerations...

### WHAT IS IMPORTANT TO YOU

#### MATERIALS

#### INSULATION MATERIALS

1. Extruded Polystyrene
2. Polyurethane

#### METAL SKINS

1. G 90 Galvanized
2. Aluminum
3. Galvalume
4. Painted G90 Galvanized
5. Stainless Steel

#### REFRIGERATION SYSTEMS

1. Remote Systems
2. Pre-assembled Remote Systems
3. Standard Top Mount
4. Side Mount Refrigeration System
5. Saddle Mount Refrigeration System
6. Penthouse Refrigeration System
7. Roll Up Refrigeration System

#### OUTDOOR APPLICATIONS

#### WALK-IN COOLERS AND FREEZERS WITHOUT A FLOOR

#### MANUFACTURER

#### CONCLUSION

*Cooler Connection*, the coolest blog in the Foodservice Industry, will keep you informed with the latest cooler news: new products, preventative maintenance and fix-it tips, fact versus fiction information, "heads-up" information such as new U.S. Department of Energy (DOE) rulings, cooler parts and accessories, and much more!

EverCheck® is a registered trademarks of Hoshizaki America, Inc., Peachtree City, Georgia.

ENERGY STAR is a joint program of the U.S. Environmental Protection Agency and the U.S. Department of Energy helping us all save money and protect the environment through energy efficient products and practices.



5' x 7' Brew Cave



Walk-in cooler

## Lancer Glycol Chillers

The **Siberian Elite** can be located in ambient temperatures, allowing valuable walk-in space to be kept free for product storage. The Siberian Elite's improved technology reduces compressor cycle times by up to 15%, minimizing compressor wear, ensuring a longer life and energy savings. Easy access to the unit via the hinged, removable lid.

### Features

- Rotationally molded inner and outer polyethylene tank offering long life and corrosion resistance
- Tank insulated with environmentally responsible, water blown non-CFC polyurethane insulation
- Air tight design of tank and lid, keeping condensation to a minimum to eliminate dilution of glycol solution
- Tank molded legs allow for easy cleaning under the unit once installed
- Easy installation and service
- Single phase power requirement (220V/60Hz) to operate both refrigeration and pump(s)
- IP56 Electrical connection
- Semi-submersible single phase pumps

### Options

- Single or dual pump options available
- 60 gal/min or 120 gal/min pump as standard. Other options available. POA.
- Refrigeration capacities available in 1-3/4 HP and 2-1/4 HP @ 14°F SST
- Manifolds complete with back check valves
- Glycol percentage check kit (refractometer)

**Polaris Beer Superchiller™** compact high performance design is an ideal option for smaller venues.

### Features

- Designed to operate in high ambient conditions up to 104°F ambient
- Long lasting stainless steel construction
- Easy to install and service with its fully insulated and sealed tank, a removeable access panel, and fully insulated circulation pump
- On-board electronics will shut the unit down should it overheat, freeze up or develop a glycol leak
- Optional 6" castors



Siberian Elite



Polaris Beer Superchiller



Condenser

	<b>Siberian Elite 1-3/4 HP</b>	<b>Siberian Elite 2-1/4 HP</b>	<b>Siberian Elite 3-1/2 HP</b>	<b>Siberian Elite 5 HP</b>	<b>Polaris 3/4 HP</b>
<b>Part Number</b>	82-4321	82-4332	82-4697	82-4699	85-3100
<b>Glycol Capacity</b>	42 gal (160 L)	42 gal (160 L)	42 gal (160 L)	42 gal (160 L)	
<b>BTU</b>	10,243 (3kw)	17,072 (5kw)	27,315 (8kw)	34,144 (10kw)	
<b>Electric</b>	220/60	220/60	220/60	220/60	
<b>Amps</b>	10	10	10	20	
<b>Pump Type</b>	(1) SPK 2-11/8	(1) SPK 2-11/8	(1) SPK 2-11/8	(2) SPK4-11/8	Grundfos
<b>Flow Rate</b>	10 GPM/600 GPH (40 LPM / 2,400 LPH)			20 GPM /1200 GPH	
<b>Thermostat</b>	Electronic	Electronic	Electronic	Electronic	
<b>Refrigerant</b>	R404A	R404A	R404A	R404A	
<b>Size: W x D x H"</b>	22.9 x 22.9 x 47.2	22.9 x 22.9 x 47.2	22.9 x 22.9 x 47.2	22.9 x 22.9 x 47.2	
<b>Condenser</b>	32L3238-2E	32L2134-2E	32L3157-2E	32L4083-2E	
<b>Condenser BTU</b>	14,300 (4.19 kw)	18,500 (5.42 kw)	29,100 (8.53 kw)	38,100 (11.17 kw)	
<b>Amps</b>	17.15	14.03	39.72	47.12	
<b>Size: W x D x H"</b>	36.3 x 26.5 x 26	36.3 x 26.5 x 26	36.3 x 26.5 x 26	7.8 x 29.4 x 31.6	

## Glycol Power Packs

Lancer Direct offers a powerful tried and true line of Glycol Power Packs that are used the world over. From 35' to 250' you can always depend on our glycol power packs to offer outstanding performance for a cold pour every time.

Rest assured that the Glycol Power Packs are ETL approved. This gives you piece of mind that our products have been independently tested and meet global safety standards.

**EXTENDED WARRANTY** - Ask your Lancer Direct sales rep about our 4 year compressor extended warranty.

**The Flat** is a great small power pack rated for 35' and perfect for the Craft Brewer who may only have one or two lines on tap. It's also the perfect deck for wine dispensing and icing towers.

**The Super Flat** is by far our best selling power pack. It's tough and affordable making it the right choice to fit your budget. You can also use the Super Flat for wine dispensing and icing towers.

**The GD Series** has established itself as the work horses out in the field. The removable lid makes it easily accessible for maintenance. Single and double pump options.



Flat  
BB989950



Super Flat  
BB989955



GD75  
BB989958



GD125  
BB989960



GD250  
BB989975

	<b>Flat</b>	<b>Super Flat</b>	<b>GD75</b>	<b>GD125</b>	<b>GD250</b>
<b>Part Number</b>	<b>BB989950</b>	<b>BB989955</b>	<b>BB989958</b>	<b>BB989960</b> (1 pump) <b>BB989963</b> (2 pumps)	<b>BB989971</b> (1 pump) <b>BB989975</b> (2 pumps)
Max. distance to tower	35 ft (10 m)	75 ft (23 m)	75 ft (23 m)	125 ft (38 m)	250 ft (76 m)
Max. distance to ice tower	10 ft (3 m)	30 ft (9.1m)	60 ft (18.3 m)	100 ft (30.5 m)	200 ft (61 m)
Compressor	1/6 HP - air cooled	1/3 HP - air cooled	1/3 HP - air cooled	1/3 HP - air cooled	1/2 HP - air cooled
Electrical specification	115V 60Hz	115V 60Hz	115V 60Hz	115V 60Hz	115V 60Hz
Amperage	4A	5.7A	5.5A	6A	8A
Plug & cord length	5-15P x 6'	5-15P x 6'	5-15P x 6'	5-15P x 6'	5-15P x 6'
Refrigerant	R134a	R404a	R404a	R134a	R134a
Chilling capacity	936 BTU/hr (274 W)	3230 BTU/hr (946 W)	3230 BTU/hr (946 W)	3568 BTU/hr (1045 W)	7030 BTU/hr (2060 W)
Bath capacity	3.2 Gal (12 L)	4.5 Gal (17 L)	4.5 Gal (17 L)	13.2 Gal (50 L)	13.2 Gal (50 L)
Shipping weight	71 lbs (32 kg)	93 lbs (59 kg)	118 lbs (54 kg)	102 or 122 lbs	107 or 127 lbs
Operational weight 1 pump	80 lbs (36 kg)	130 lbs (59 kg)	145 lbs (56 kg)	205 lbs (93 kg)	210 lbs (95 kg)
Operational weight 2 pumps	N/A	N/A	N/A	220 lbs (100 kg)	225 lbs (102 kg)
Dimensions l x d x h (including pump)	17 x 18 x 14"	25 x 17 x 16"	25 x 17 x 17"	18 x 24 x 29" 24 x 24 x 29"	18 x 24 x 29" 24 x 24 x 29"
Recirculation pump(s)	4/12 050 mm vertical centrifugal	8/10 037.5 mm vertical centrifugal	75 GPH top mount rotary vane pump	75 GPH side mount rotary vane pump	75 GPH side mount rotary vane pump
Recirculation pump motor	Part of pump assy	Part of pump assy	1/3 HP - 1725 RPM 115V 60Hz 6.5A	1/3 HP - 1725 RPM 115V 60Hz 6.5A	1/3 HP - 1725 RPM 115V 60Hz 6.5A
Thermostat	Digital programmable	Digital programmable	Digital programmable	Digital programmable	Digital programmable
Default temperature setting	26°F (-3.3°C)	26°F (-3.3°C)	26°F (-3.3°C)	26°F (-3.3°C)	26°F (-3.3°C)
Default differential setting	2°	2°	2°	2°	2°
Inlet/outlet	1/2" OD push-in fittings	1/2" OD push-in fittings	3/8" (9.5mm) barbs	3/8" (9.5mm) barbs	3/8" (9.5mm) barbs
Approval	ETL Listed	ETL Listed	ETL Listed	ETL Listed	ETL Listed

## Glycol Power Pack 4 Year Extended Compressor Warranty

Part #	Description
875150-04	Flat - BB989950 compressor
875153-04	Super Flat - BB989955 compressor
875153-04	GD75 single pump - BB989958 compressor
875159-04	GD125 single pump - BB989960 compressor
875162-04	GD125 double pump - BB989963 compressor
875165-04	GD250 single pump - BB989971 compressor
875168-04	GD250 double pump - BB989975 compressor

*Glycol trunk line is shown on page 44  
Glycol and glycol manifolds are shown on page 43  
Tape insulation is shown on page 55*



GD250  
BB989971



## Pump Assembly & Parts for GD Power Packs

Part #	Description
BB989860	1/3 HP motor and 75GPH pump complete assembly
MP000485	Rotoflow pump, 75 gph, no barbs
MP000499	Rotoflow pump jacket (foam)
MP000448	Dumper coupling kit
MP000450	Clamp V-band
CO881742	Brass 3/8" MPT x 3/8" barb

*More rotary vane pumps are shown on page 41*



MP000448



MP000499

## Cold Kit Components

Part #	Description
BB431910	3/8" OD ACR copper cooling loop
1007042	SS 3/8" OD Tube Compression x 3/8" Barb
C228	Cold block, fits 7/8" shank



C228



BB996041

## Glycol Power Pack Replacement Parts

Part #	Description
MP000483	50 GPH brass rotary vane pump
MP000485	75 GPH brass rotary vane pump
MP000479	100 GPH brass rotary vane pump w strainer
MP000487	105 GPH brass rotary vane pump
BB996020	Flat - replacement pump
BB996001	Flat - replacement fan & motor
BB996041	Flat - replacement thermostat
BB996075	Flat - replacement probe
BB996061	Flat - 1/6 HP replacement compressor
BB996024	Super Flat - replacement pump
BB996004	Super Flat - replacement fan & motor
BB996075	Super Flat - replacement probe
BB996041	Super Flat - replacement thermostat
BB996067	Super Flat - 1/3 HP replacement compressor
BB996068	GD125 - 1/3 HP replacement compressor
BB996008	GD125 - replacement fan motor
BB996075	GD125 - replacement probe
BB996041	GD125 - replacement thermostat
BB996071	GD250 - 1/2 HP replacement compressor
BB996008	GD250 - replacement fan motor
BB996075	GD250 - replacement probe
BB996041	GD250 - replacement thermostat
MP551740	1/3 HP motor with cord for GD125 & 250

## Vin Service Flash Coolers

Install a flash cooler to cool beer, wine, cider, water, juices or soda. Beverage in temperature 77°F, out temperature 42.8°F. John Guest Superseal fittings on page 113 are recommended for stainless steel tubing. Cold kit components are shown on the previous page. EXTENDED WARRANTIES AVAILABLE.



BB900205



BB900214



BB900219



BB900222

	<b>Flat</b>	<b>HE60</b>	<b>HE90V</b>	<b>HE120V</b>
<b>Part Number</b>	<b>BB900205</b>	<b>BB900214 (Beer)</b> <b>BB900217-W (Wine)</b>	<b>BB900219</b>	<b>BB900222 (4 line)</b> <b>BB900224 (6 line)</b>
SS product lines	2	4	4	4/6
Cooling capacity	6.6 gal/hr	15.9 gal/hr	23.8 gal/hr	31.7 gal/hr
Drink rate (6.7 oz)	3/min	5/min	7/min	10/min
Compressor	1/6 HP	1/4 HP	1/3 HP	1/2 HP
Electrical specification	115V 60Hz	115V 60Hz	115V 60Hz	115V 60Hz
Refrigerant	R404a	R404a	R404a	R404a
Chilling capacity	936 BTU/hr (127 W)	1580 BTU/hr (260 W)	1809 BTU/hr (311 W)	2581 BTU/hr (415 W)
Bath capacity	3.2 gal	6.6 gal	9.5 gal	13.2
Ice bank	11 lbs	26 lbs	30 lbs	55 lbs
Weight	50 lbs	74 lbs	77 lbs	77 lbs
Dimensions l x d x h	16 x 16 x 11"	14.2 x 22 x 19.3"	15.4 x 15.4 x 28.4"	17.7 x 17.7 x 31.5"

*Glycol trunk line is shown on page 44*  
*Glycol and glycol manifolds are shown on page 43*  
*Tape insulation is shown on page 55*

## Vin Service Flash Cooler Replacement Parts

<b>Part Number</b>	<b>Description</b>
BB996029	Pump assembly for flat flash cooler
BB996033	Pump assembly for HE60 flash cooler
BB996037	Pump assembly for HE90 & HE120 flash coolers
BB996041	Digital thermostat for flash coolers & glycol power packs
BB996045	Ice bank control for flash coolers
BB996075	Probe for digital thermostat - BB996041
BB996010	Fan blade for VS glycol and VS flash chillers
BB996064	1/4 HP R404A compressor for HE60 flash chiller
BB996079	VS probe wire for HE60 / HE90 / HE120





## Glycol Power Packs



GD-033



GD-WA-12  
GD-WA-13  
GD-WA-34

Part #	Description
GD-033	Glycol power pack 1/3 HP Totten pump
GD-WA-12	Glycol power pack 1/2 HP standard pump
GD-WA-13	Glycol power pack 1/3 HP standard pump
GD-WA-34	Glycol power pack 3/4 HP standard pump

## Lancer Chiller Plates

Flash chillers ensure your customers will receive an **ICE COLD** beer, glass after glass. They reduce foam waste, retain beer gases, increase customer satisfaction and profit. Suitable for high and low volume, and cider. There are no moving parts, no need for service, and can be installed in small spaces in any position, or retro-fitted in an existing system.

316 grade stainless steel product coils and casing. Aluminum cold plate. Temperature probe housing. 3/8" stainless steel barbed beer connections. 1/2" barbed glycol line connections.



Lancer  
Chiller Plate  
17W x 24.5D x 6"H

Part Number	Description
82-4671	Chiller plate, 6 coil, 3/8" barbs
82-4672	Chiller plate, 8 coil, 3/8" barbs

## Chiller Parts and Accessories



Series 1



Series 2



Series 3



83000184



S48AB88B92P



AO-PUMP-ASSY



Grundfos Pump

Part Number	Description
6000520	Insulation block for Procon pumps
101A050F11AA170	Procon pump brass series 1 (CO1310) 50 GPH, 170 psi
111A100F11AA250	Procon pump brass series 1 (CO1304M250) 100 GPH, 250 psi
111A100F11BA170	Procon pump brass series 1 (CO1304X) 100 GPH, 170 psi
102A050F11AA170	Procon pump brass series 2 (CO1510) 50 GPH, 170 psi
102A100F11BD055	Procon pump brass series 2 (CO1504XD) 100 GPH, 55 psi
112A050F11AA100	Procon pump brass series 2, 50 GPH, 100 psi
112A050F11AA170	Procon pump brass series 2, 50 GPH, 170 psi
112A060F11DB130	Procon pump brass series 2 (CO1509BXL) 60 GPH, 130 psi
112A070F11AA170	Procon pump brass series 2 (CO1508) 70 GPH, 170 psi
112A100F11BA170	Procon pump brass series 2 (CO1504X) 100 GPH, 170 psi
113A050F31XX	Procon pump SS series 3 (CO1610A) 50 GPH
113A100F31BA170	Procon pump SS series 3 (CO1604X) 100 GPH, 170 psi
113A100F31XX	Procon pump SS series 3 (CO1604A)
113E100F31BA170	Procon pump SS series 3 (B01604X) 100 GPH, 170 psi
141A100F11AA250	Procon pump low lead series series 1, 100 GPH, 250 psi

Part Number	Description
AO-PUMP-ASSY	Add-on pump assembly
4406	1/3 HP GE recirculating motor, welded base, 115V
4805	1/3 HP GE recirculating motor, 115/230V (dual)
83000184	Carel PJ Easy Thermostat
HPR 6/8	Recirculating pump 5.5 GPM, 145 psi
HPR 6/11	Recirculating pump 5.5 GPM, 145 psi
86-0183	Grundfos replacement pump SPK4-11/8
86-0182	Grundfos replacement pump SPK2-11/8
GP20/12	Recirculating pump 4.6 GPM, 36.3 psi
GP20/18	Recirculating pump 4.8 GPM, 36.3 psi
S48AB88B92P	1/3 HP recirculating motor & pump, 115V/60hz, 1725RPM, automatic overload, 48Y frame, resilient base, open drip proof construction
32L3238-2E	Condensing unit R404a, 11,700 BTU
32L2134-2E	Condensing unit R404a, 17,300 BTU
82-4426	Inline heat exchanger, 1 coil

## Beer/Soda Centrifugal Chilling Pumps

Magnetically coupled and semisubmersible pumps for recirculating chilled water or water/glycol in beer coolers and carbonated water in soft drinks coolers. Produces heads up to 24m. Fluid temperature: -4° to +185° F.

### HPR

Application: continuous recirculation of carbonated water, aggressive chemicals, chilled water, pure or precious liquids in high pressure systems

- Manufactured from food grade thermoplastics
- Magnetic coupling provides an energy efficient thermal shield, minimizing heat transfer to the pumped fluid
- Temperature stability and product purity ensured
- Leak free continuous operation, low condensation
- Nitrile 'O' rings standard, other materials available
- Zero maintenance, long life
- PPS pump head

### GP

Application: cost effective high head, continuous low flow for the transfer and recirculation of water and glycol solutions

- Magnetic couplings provide an energy efficient thermal shield, minimising heat transfer to the pumped fluids
- Variable pump body orientation, IPX5 motor enclosure
- Adaptable mounting foot positions
- Compatible with standard fittings
- Deep groove ball bearings

### SPC

Application: continuous operation in, chillers, coolers, vending and general water applications

- Low maintenance and long life
- Available with plugs and leads to suit application
- Agitator propeller fitted as standard
- SPC 51 is top mounted with keyhole mounting plate and has IPX4 motor housing

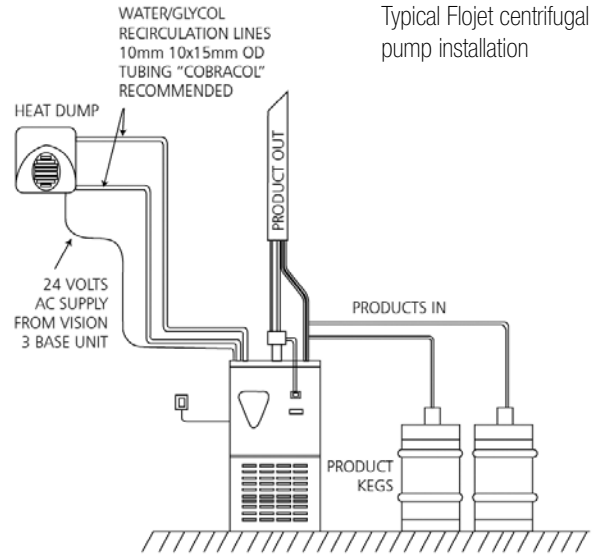

Typical Flojet centrifugal pump installation



Part Number	Ports	PSI	Flow Rate	Size H x W x D"	Voltage
HPR 6/8	1/2" (12.5mm) or 15mm OD	145	5.5 GPM	3.86" H x 6.95" W x 4.45" D	110V 1Ph 50/60Hz
HPR 6/11	1/2" (12.5mm) or 15mm OD	145	5.5 GPM	3.86" H x 6.95" W x 4.45" D	110V 1Ph 50/60Hz
GP20/12	Plain 15 mm, 3/8" MPT, or 3/8" bsp Male	36.3	4.6 GPM	5.6" x 8.6" x 4.6"	110V 1Ph 50Hz
GP20/18	Plain 15 mm, 3/8" MPT, or 3/8" bsp Male	36.3	4.8 GPM	5.6" x 10.1" x 4.6"	110V 1Ph 50Hz
SPC 8/2	Plain 0.47 in (12 mm)	3	2.1 GPM	6.85"H x 8.82"L	110V 1Ph 50Hz
SPC 12/4	Plain 0.51 (13 mm)	5.3	3.4 GPM	3.1" x 8.5" x 4.3"	110V 1Ph 50Hz
SPC 42	1/2" (12.5mm) and 11mm	17.5	3.4 GPM	4.61"H x 12.56"L	110V 1Ph 50Hz
SPC 43	1/2" (12.5mm) and 11mm	26	2.1 GPM	5.39"H x 14.17"L	110V 1Ph 50Hz
SPC 44	1/2" (12.5mm) and 11mm	32	3.4 GPM	5.39"H x 14.7"L	110V 1Ph 50Hz
SPC 51	1/2" (12.5mm) and 11mm	9	4.17 GPM	5.27"H x 3.21"L	110V 1Ph 50Hz

## Propylene Glycol

Propylene glycol is a colorless, odorless, biodegradable heat transfer liquid commonly used as an anti-freeze or coolant. The products on this page are non-toxic, food quality (not food grade\*) and can be used in chillers, refrigeration and other mechanical systems where food is processed, but not where it will come in direct contact with food.



BB990300 Glycol tester reads the glycol/water ratio in the Power Pack bath

Part #	Description	% Glycol	Corrosion Inhibitor	Color Additive	Gallons	Units Per Carton
35714	Profrost	100%	No	No	5	1
35715	Profrost	100%	No	No	55	1
35720	Profrost - I	100%	Yes	No	5	1
35721	Profrost - I	100%	Yes	No	55	1
35723	Profrost - Cl	100%	Yes	Yes	5	1
35722	Profrost - Cl	100%	Yes	Yes	55	1
35760	Freeze Safe Valuline	80%	Yes	Yes	1	4
35761	Freeze Safe Valuline	80%	Yes	Yes	5	1
35762	Freeze Safe Valuline	80%	Yes	Yes	55	1
35711	PG Food Quality Pre-mix	40%	Yes	No	5	1
35712	PG Food Quality Pre-mix	40%	Yes	No	55	1
4188-06	Glycol, 5 gallon pail				5	
95-0232	Glycol 5 gallons				5	

## Glycol Manifolds

Lancer insulated glycol distribution manifolds feature insulated bodies, and check valves to prevent water siphon. Manifolds can be mounted stainless steel boards or directly on keg room wall.

- Fully insulated, temperature resistant brackets
- Check valves prevent water siphon
- 1/2" barbed glycol supply and return lines
- 1 or 2 pump supply
- 2, 4, 6, 8, 10 and 12 point supply and return manifolds



48-3051



48-3066

Part #	Description
48-3050	Glycol manifold assy SS 1 pump supply, 2 way
48-3051	Glycol manifold assy SS 1 pump supply, 4 way
48-3052	Glycol manifold assy SS 1 pump supply, 6 way
48-3053	Glycol manifold assy SS 1 pump supply, 8 way
48-3054	Glycol manifold assy SS 1 pump supply, 10 way
48-3055	Glycol manifold assy SS 1 pump supply, 12 way
48-3056	Glycol manifold assy SS 2 pump supply, 2 way
48-3057	Glycol manifold assy SS 2 pump supply, 4 way
48-3058	Glycol manifold assy SS 2 pump supply, 6 way
48-3059	Glycol manifold assy SS 2 pump supply, 8 way
48-3060	Glycol manifold assy SS 2 pump supply, 10 way
48-3061	Glycol manifold assy SS 2 pump supply, 12 way
48-3063	Glycol manifold assy SS return, 2 way
48-3064	Glycol manifold assy SS return, 4 way
48-3065	Glycol manifold assy SS return, 6 way
48-3066	Glycol manifold assy SS return, 8 way
48-3067	Glycol manifold assy SS return, 10 way
48-3068	Glycol manifold assy SS return, 12 way

## Insulated Barrier Tubing Bundles with Coolant Lines

Bev-Seal Ultra® Series 971 non-cabled and Series 973 cabled insulated bundles are comprised of flushable Bev-Seal Ultra® Series 235 tubes.

Part Number	# Lines	OD"	Tube ID" x OD"	Std. Size	Clamp
971-0004002X250	6	3.0	(4) 3/8 x 1/2 (2) 3/8 x 1/2	250'	14.0
971-0006002X100	8	3.4	(6) 3/8 x 1/2 (2) 3/8 x 1/2	100'	14.0
971-0006002X250	8	3.4	(6) 3/8 x 1/2 (2) 3/8 x 1/2	250'	14.0
973-0008002X250	10	3.5	(8) 3/8 x 1/2 (2) 3/8 x 1/2	250'	14.0
973-0010004X250	14	3.5	(10) 3/8 x 1/2 (4) 3/8 x 1/2	250'	14.0
973-0012004X250	16	4.0	(12) 3/8 x 1/2 (4) 3/8 x 1/2	250'	14.0



All bundles have extruded jackets. Other jacket colors are available. Other bundle configurations are available, minimum order quantity may apply. Additional cutting charges for special lengths.

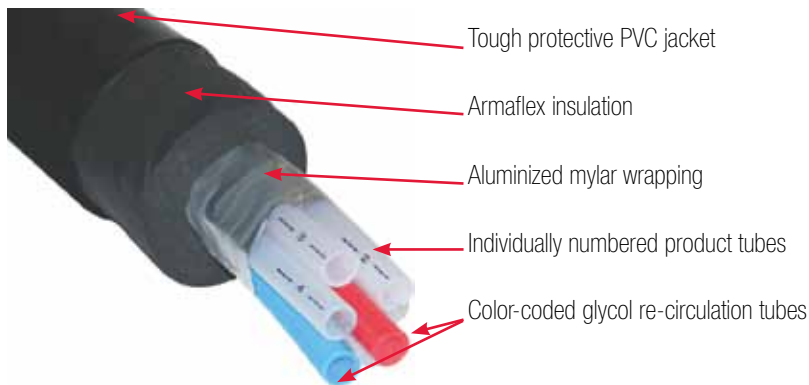

Part Number	# Lines	Product	Glycol	Insulation	Jacket
BT042260	4	(2) 5/16"	(2) 3/8"	3/4"	PVC jacket, fire rated
BT064260	6	(4) 5/16"	(2) 3/8"	3/4"	PVC jacket, fire rated
BT086260	8	(6) 5/16"	(2) 3/8"	3/4"	PVC jacket, fire rated
BT108260	10	(8) 5/16"	(2) 3/8"	3/4"	PVC jacket, fire rated
BT1410460	14	(10) 5/16"	(4) 3/8"	3/4"	PVC jacket, fire rated
BT1612460	16	(12) 5/16"	(4) 3/8"	3/4"	PVC jacket, fire rated
BT042290	4	(2) 3/8"	(2) 3/8"	3/4"	PVC jacket, fire rated
BT064290	6	(4) 3/8"	(2) 3/8"	3/4"	PVC jacket, fire rated
BT086290	8	(6) 3/8"	(2) 3/8"	3/4"	PVC jacket, fire rated
BT108290	10	(8) 3/8"	(2) 3/8"	3/4"	PVC jacket, fire rated
BT1410490	14	(10) 3/8"	(4) 3/8"	3/4"	PVC jacket, fire rated
BT1612490	16	(12) 3/8"	(4) 3/8"	3/4"	PVC jacket, fire rated

## Insulated Barrier Tubing Trunk Lines with Coolant Lines

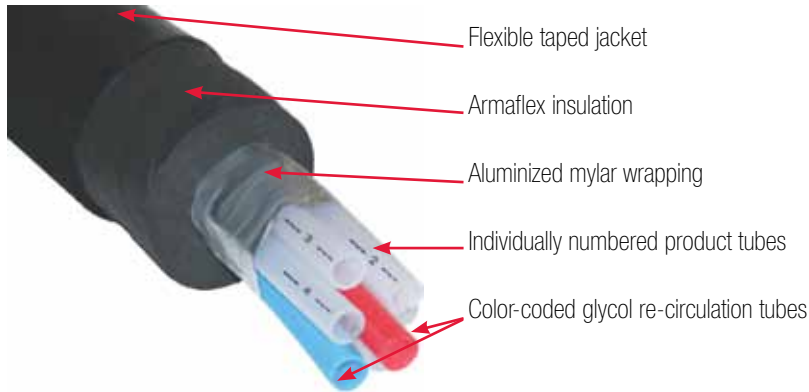

Part Number	# Lines	Product	Glycol	Insulation	Jacket
BT042257	4	(2) 5/16"	(2) 3/8"	3/4"	Flexible taped jacket, fire rated
BT064257	6	(4) 5/16"	(2) 3/8"	3/4"	Flexible taped jacket, fire rated
BT086257	8	(6) 5/16"	(2) 3/8"	3/4"	Flexible taped jacket, fire rated
BT108257	10	(8) 5/16"	(2) 3/8"	3/4"	Flexible taped jacket, fire rated
BT1410457	14	(10) 5/16"	(4) 3/8"	3/4"	Flexible taped jacket, fire rated
BT1612457	16	(12) 5/16"	(4) 3/8"	3/4"	Flexible taped jacket, fire rated
BT1814457	18	(14) 5/16"	(4) 3/8"	3/4"	Flexible taped jacket, fire rated, <i>SPECIAL ORDER</i>
BT042287	4	(2) 3/8"	(2) 3/8"	3/4"	Flexible taped jacket, fire rated
BT064287	6	(4) 3/8"	(2) 3/8"	3/4"	Flexible taped jacket, fire rated
BT086287	8	(6) 3/8"	(2) 3/8"	3/4"	Flexible taped jacket, fire rated
BT108287	10	(8) 3/8"	(2) 3/8"	3/4"	Flexible taped jacket, fire rated
BT1410487	14	(10) 3/8"	(4) 3/8"	3/4"	Flexible taped jacket, fire rated
BT1612487	16	(12) 3/8"	(4) 3/8"	3/4"	Flexible taped jacket, fire rated
BT1814487	18	(14) 3/8"	(4) 3/8"	3/4"	Flexible taped jacket, fire rated, <i>SPECIAL ORDER</i>

## Dual Core Wine Trunk Line

First trunk line in the wine industry with dedicated cooling lines for white wine, and separated by 1/2" insulation to two more lines for ambient controlled red wine. All lines are wrapped with mylar foil tape, 3/4" foam insulation and then covered by a durable taped protective jacket. FDA approved.

Part #	Description
BT040122	2+(2+2) dual core taped 1/4" ID x 3/4" OD barrier trunk line for wine
BT060133	3+(3+2) dual core taped 1/4" ID x 3/4" OD barrier trunk line for wine
BT080144	4+(4+2) dual core taped 1/4" ID x 3/4" OD barrier trunk line for wine
BT100155	5+(5+2) dual core taped 1/4" ID x 3/4" OD barrier trunk line for wine

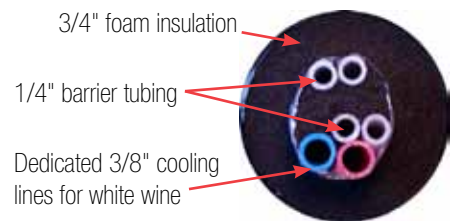

## Glycol Power Pack Trunk Line

Use to connect glycol power pack to trunk line. Kit contains:

- 3/8" ID color coded glycol tubes (red + blue)
- Moisture barrier wrap
- Foil wrap
- 3/4" wall insulation

Part #	Description
08-0579	1 glycol line 1"ID, 3/4" insulation
BT020200	2 glycol lines, 3/4" insulation
BT020400	4 glycol lines, 3/4" insulation

## Single Line Barrier Tubing

Bev-Seal Ultra® barrier tubing with Glas-Flex™ liner allows changeovers from even the most pungent flavors with simple flushing procedures. Dual-Barrier construction: flushable Glas-Flex™ inner liner is surrounded by a seamless extruded barrier layer in a coextruded polyolefin tube.

XX indicates the trace color and number to be imprinted: use 00 for unnumbered hose, 01=blue, 02=black, 03=red, 04=green, 05=yellow, 06=orange, 07=brown, 08=white, 09=pink, 10=purple, 11=blue, 12=black, 13=red, 14=green.

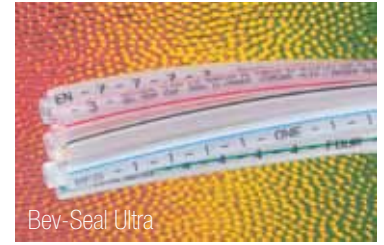
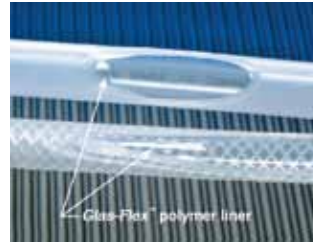

Part Number	Tube ID" x OD"	Std. Package	Clamp	Additional Information
235-05620-xx	3/16 x 5/16	500' spool	8.7	Glas-Flex liner
08-0619	1/4 x 3/8	500' spool	10.0	Glas-Flex liner
08-0620	5/16 x 7/16	100' spool	11.3	Glas-Flex liner
08-0621	3/8 x 1/2	500' spool	14.0	Glas-Flex liner
08-0622	1/2 x 5/8	100' wrapped coil	17.0	Glas-Flex liner

## Single Line Braided Barrier Hose

Bev-Seal Ultra® barrier tubing with Glas-Flex™ liner allows changeovers with simple flushing procedures. Dual-Barrier construction: flushable Glas-Flex™ inner liner is surrounded by a seamless extruded barrier layer in a polyolefin core tube, reinforced with polyester yarn and protected by a smooth EVA (ethylene vinyl acetate) cover. XX indicates the imprinted number (see above).



Part Number	Tube ID" x OD"	Std. Package	Clamp	Additional Information
175-04500-xx	1/4 x 7/16	500' boxed spool	11.3	Yarn reinforced
175-06300-xx	3/8 x 1/2	300' boxed spool	14.5	Yarn reinforced

## Single Line Wire-Reinforced Braided Barrier Hose

Bev-Steel® Ultra barrier tubing with Glas-Flex™ liner allows changeovers from even the most pungent flavors with simple flushing procedures. All of the features of the Series 175 hose plus the superior protection and physical strength of a stainless steel wire mesh reinforcement layer. The wire mesh provides protection against rodent attack, while the Dual-Barrier construction prevents permeation of aromas that would attract rodents and other pests.



Part Number	Tube ID" x OD"	Std. Package	Clamp	Additional Information
178-04100	1/4 x 1/2	100' boxed coil	14.0	Wire reinforced
178-04300	1/4 x 1/2	300' boxed spool	14.0	Wire reinforced
178-06100	3/8 x 5/8	100' boxed coil	17.0	Wire reinforced
178-06300	3/8 x 5/8	300' boxed spool	17.0	Wire reinforced

**Solid Color Single Line Braided Barrier Tubing**

Reinforced Bevlex® Plus 180 hoses are ideal for pressure lines, while providing good kink resistance. They are recommended for use on filtered water and carbonated water lines where algae growth can be a concern, thus assuring good taste protection properties and pressure performance. Construction: Glas-Flex™ (PET) liner, polyester yarn reinforcement, opaque EVA silver (-SIL) jacket.



Part Number	Tube ID" x OD"	Std. Package	Clamp	Additional Information
180-04100-SIL	1/4 x 1/2	100' boxed coil	13.3	Yarn reinforced
180-04500-SIL	1/4 x 1/2	500' boxed spool	13.3	Yarn reinforced
180-06100-SIL	3/8 x 5/8	100' boxed coil	15.7	Yarn reinforced
180-06300-SIL	3/8 x 5/8	300' boxed spool	15.7	Yarn reinforced
180-08100-SIL	1/2 x 3/4	100' boxed coil	19.8	Yarn reinforced
180-08300-SIL	1/2 x 3/4	300' boxed spool	19.8	Yarn reinforced

**Braided Non-Barrier Polyethylene Hose**

Bev-Flex® Series 172 polyester-reinforced polyethylene beverage hose provides low odor and taste, excellent stress crack resistance and exceptional flexibility. Polyester reinforcement provides pressure performance and kink-resistance exceeding that of simple tubing. Smooth EVA (ethylene vinyl acetate) cover.



Replace X with tracer yarn color: white (0), red (1) and blue (2).

Part Number	Tube ID" x OD"	Std. Package	Clamp	Additional Information
172-041X4-00	1/4 x 3/8	100' boxed coil	10.5	Yarn reinforced
172-048X4-00	1/4 x 3/8	800' boxed spool	10.5	Yarn reinforced
172-041X3-00	1/4 x 7/16	100' boxed coil	11.3	Yarn reinforced
172-045X3-00	1/4 x 7/16	500' boxed spool	11.3	Yarn reinforced
172-041X2-00	1/4 x 15/32	100' boxed coil	12.3	Yarn reinforced
172-045X2-00	1/4 x 15/32	500' boxed spool	12.3	Yarn reinforced
172-061X3-00	3/8 x 5/8	100' boxed coil	15.7	Yarn reinforced
172-063X3-00	3/8 x 5/8	300' boxed spool	15.7	Yarn reinforced
172-061X0-00	3/8 x 19/32	100' boxed coil	15.7	Yarn reinforced
172-063X0-00	3/8 x 19/32	300' boxed spool	15.7	Yarn reinforced
172-081X0-00	1/2 x 3/4	100' boxed coil	19.8	Yarn reinforced
172-083X0-00	1/2 x 3/4	300' boxed spool	19.8	Yarn reinforced

## Braided Non-Barrier Polyethylene Hose

Bevlex® Series 170 polyester-reinforced polyethylene beverage hose LLDPE core tube construction provides excellent stress crack resistance. Polyester reinforcement provides pressure performance and kink-resistance exceeding that of simple tubing. Bonded abrasion-resistant copolymer jacket — will not separate or ripple in tight bends or during installation in conduits



Replace X with tracer yarn color: white (0), red (1) and blue (2).

Part Number	Tube ID" x OD"	Std. Package	Clamp	Additional Information
170-041X2-00	1/4 x 15/32	100' boxed coil	13.3	Yarn reinforced
170-045X2-00	1/4 x 15/32	500' boxed spool	13.3	Yarn reinforced
170-045X6-00	1/4 x 1/2	500' boxed spool	14.0	Yarn reinforced
170-063X0-00	3/8 x 19/32	300' boxed spool	15.7	Yarn reinforced
170-065X0-00	3/8 x 19/32	500' reel	15.7	Yarn reinforced
170-061X0-00	3/8 x 5/8	100' boxed coil	17.0	Yarn reinforced
170-063X0-00	3/8 x 5/8	300' boxed spool	17.0	Yarn reinforced
170-083X0-00	1/2 x 3/4	300' wrapped coil	19.8	Yarn reinforced
170-085X0-00	1/2 x 3/4	500' reel	19.8	Yarn reinforced

## Single Line Non-Barrier Beverage Tubing

Low density, LLDPE industrial grade colored, taste-free tubing for syrup, liquor, or glycol transfer. Excellent stress-crack and UV resistance. 222 Series has no numbers. 224 Series is numbered.

XX indicates the number to be imprinted, 1-12. For single digit numbers place a zero before the number. For example, if you want the printed number to be "2" replace "xx" with "02".



Part Number	Tube ID" x OD"	Std. Package	Clamp	Additional Information
222-0440X2K	3/16 x 1/4	2000' boxed spool	7.0	Natural
222-0440X500	3/16 x 1/4	500' boxed spool	7.0	Natural
08-0617	1/4 x 3/8	100' boxed spool	10.0	Natural
08-0618	3/8 x 1/2	100' boxed spool	14.0	Natural
222-1062X500	1/2 x 5/8	500' wrapped coil	17.0	Natural
224-06620-xx	1/4 x 3/8	500' boxed spool	10.0	Numbered
224-08620-xx	3/8 x 1/2	500' boxed spool	14.0	Numbered
224-10620-xx	1/2 x 5/8	500' wrapped coil	17.0	Numbered

Part Number	Tube ID" x OD"	Std. Package	Clamp	Additional Information
228-07620-00	3/16 x 5/16	500' wrapped coil	8.7	Barrier tubing for beer



## CLEARBRAID® PVC Hose

Blue-tinted crystal clear hose is ideal for flexible water or juice lines. Spiraled polyester yarn reinforcement with multiple longitudinal polyester yarns provide pressure performance and kink resistance. Glass smooth interior. K3150 Series has an orange tracer. Thick walled K3130 Series has a blue tracer.



Part Number	Tube ID" x OD"	Std. Package	Clamp	Additional Information
K3150-03	3/16 x 3/8	100'/300' coil	10.0	Yarn reinforced, orange tracer
08-0613	1/4 x 7/16	100' coil	11.8	Yarn reinforced, orange tracer
08-0614	5/16 x 17/32	100' coil	14.5	Yarn reinforced, orange tracer
08-0615	3/8 x 5/8	100' coil	15.7	Yarn reinforced, orange tracer
08-0616	1/2 x 3/4	100' coil	19.8	Yarn reinforced, orange tracer
K3150-10	5/8 x 7/8	100'/200' coil	22.6	Yarn reinforced, orange tracer
K3150-12	3/4 x 1	100'/200' coil	25.6	Yarn reinforced, orange tracer
K3150-16	1 x 1-5/16	100'/200' coil	33.1	Yarn reinforced, orange tracer
K3150-20	1-1/4 x 1-5/8	50'/100' coil	42.5	Yarn reinforced, orange tracer
K3150-24	1-1/2 x 2	50'/100' coil	50.0	Yarn reinforced, orange tracer
K3150-32	2 x 2-1/2	50'/100' coil	65.0	Yarn reinforced, orange tracer
K3130-06x100	3/8 x 9/16	100' coil	14.5	Heavy wall reinforced
K3130-12x100	3/4 x 1-1/8	100' coil	28.6	Heavy wall reinforced
K3130-12x200	3/4 x 1-1/8	200' coil	28.6	Heavy wall reinforced
K3130-24x100	1-1/2 x 2	100' coil	51.5	Heavy wall reinforced

## Polyspring Clear Reinforced PVC Vacuum & Transfer Hose

Embedded steel spring reinforcement provides flexibility and resistance to kinking, crushing and collapsing. Glass smooth interior.



Part Number	Hose ID" x OD"	Std. Package	Clamp
K7160-04	1/4 x 1/2	100'/300' coil	13.8
K7160-06	3/8 x 5/8	100'/300' coil	15.7
K7160-08	1/2 x 3/4	100'/300' coil	19.8
K7160-10	5/8 x 7/8	100'/300' coil	22.6
K7160-12	3/4 x 1	100'/300' coil	28.6
K7160-16	1 x 1-5/16	100'/300' coil	33.1
K7160-20	1-1/4 x 1-9/16	50'/100' coil	42.5
K7160-24	1-1/2 x 1-7/8	50'/100' coil	50.0
K7160-32	2 x 2-3/8	50'/100' coil	62.0
K7160-36	2-1/4 x 2-3/4	50'/100' coil	72.5
K7160-40	2-1/2 x 3	50'/100' coil	78.5
K7160-48	3 x 3-1/2	50'/100' coil	90.5

## Clear Food-Grade PVC Tubing

Klearon Series, K010, non-toxic blue-tinted, crystal clear, ozone resistant, self-extinguishing, flexible tubing has a glass smooth interior and is in compliance with FDA<sup>(03)</sup>, USDA<sup>(17)</sup>, 3A<sup>(01)</sup>, NSF<sup>(13)</sup>, UL<sup>(16)</sup>, RoHS<sup>(15)</sup> and USP<sup>(18)</sup> Class VI requirements. Excellent kink resistance and taste protection properties.



Part Number	Hose ID" x OD"	Std. Package	Clamp
K010-0204	1/8 x 1/4	100' payout carton	6.5
K010-0305	3/16 x 5/16	100' payout carton	8.0
K010-0406	1/4 x 3/8	100' payout carton	10.0
K010-0507	5/16 x 7/16	100' payout carton	11.3
K010-0609	3/8 x 9/16	100' payout carton	14.5
K010-0610	3/8 x 5/8	100' payout carton	17.0
K010-1012	5/8 x 3/4	100' boxed coil	19.8
K010-1418	7/8 x 1-1/8	100' boxed coil	28.6
K010-1620	1 x 1-1/4	100' wrapped coil	33.1
K010-1624	1 x 1-1/2	100' wrapped coil	38.1

## Clear and Colored PVC Tubing

Bevlex® Series 200 clear, flexible tubing is ideal for bag-in-box soft drink applications and draft beer transfer. Excellent kink resistance and taste protection properties. Series 203 black beer tubing is ideal for carbon dioxide supply lines. Series 204 red beer tubing is designed for air supply lines.



Part Number	Hose ID" x OD"	Std. Package	Clamp	Additional Information
08-0608	3/16 x 7/16	100' payout carton	12.3	Clear beverage line
08-0609	1/4 x 1/2	100' payout carton	13.3	Clear beverage line
08-0610	5/16 x 9/16	100' payout carton	15.7	Clear beverage line
08-0611	3/8 x 5/8	100' payout carton	17.0	Clear beverage line
200-0610x60	3/8 x 5/8	60"	17.0	Clear beverage line
200-0610x78	3/8 x 5/8	78"	17.0	Clear beverage line
200-0610x84	3/8 x 5/8	84"	17.0	Clear beverage line
200-0610x92	3/8 x 5/8	92"	17.0	Clear beverage line
200-0610x98	3/8 x 5/8	96"	17.0	Clear beverage line
200-0610x120	3/8 x 5/8	120"	17.0	Clear beverage line
200-0610x500	3/8 x 5/8	500'	17.0	Clear beverage line
200-0812x100	1/2 x 3/4	100' payout carton	19.8	Clear beverage line
203-0307x100	3/16 x 7/16	100' payout carton	12.3	Black, CO <sub>2</sub> supply line
203-0610x100	3/8 x 5/8	100' payout carton	17.0	Black, CO <sub>2</sub> supply line
08-0607	5/16 x 9/16	100' payout carton	15.7	Red, air supply line
209B-BE0509x100	5/16 x 9/16	100' payout carton	15.7	Blue, PVC tubing

## Reinforced PVC CO<sub>2</sub> Vent Hose

Ideal for venting excess carbon dioxide gas from bulk storage systems. The core and jacket are a proprietary PVC blend that has excellent low temperature operating properties that resists cracking at -109°F (-78°C). Heavy walled construction resists crushing and kinking, providing ease of handling during use.

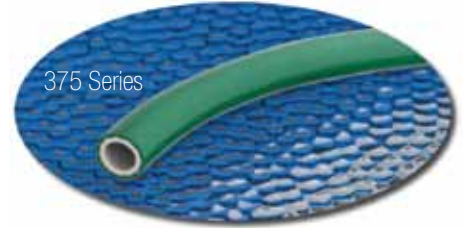

Part Number	Hose ID" x OD"	Std. Package	Clamp
375-08X300	1/2 x 3/4	300' coil	22.6

## Barrier Protected UV Resistant CO<sub>2</sub> Supply Hoses

Bev-Seal® Series 176 barrier hose is ideal for pressure regulated CO<sub>2</sub> supply lines up to 300 PSI WP @ RT. It is recommended for supplying regulated CO<sub>2</sub> gas to carbonators. It provides excellent barrier protection from environmental contamination. In addition to the exclusive custom formulated outer jacket compounds, the cover jacket is co-extruded with a unique Duo-Ex white over black combination that provides the optimum in UV and weather resistance.



Part Number	Hose ID" x OD"	Std. Package	Clamp
176-04502-NCW	1/4 x 1/2	500' boxed spool	13.3
176-06302-NCW	3/8 x 9/16	300' boxed spool	15.7

## Accuflex Beverage Transfer Products for Handling CO<sub>2</sub>

The following beverage hoses are approved for CO<sub>2</sub> transfer to beverage equipment.

- Bev-Flex® Series 172 polyester-reinforced polyethylene hose
- Bevlex® Series 170 polyester-reinforced polyethylene hose
- Bevlex® Plus 180 reinforced hose
- Bev-Seal Ultra® Series 175 barrier hose
- Bev-Steel® Ultra Series 178 wire-reinforced barrier hose
- CLEARBRAID® Series K3150 reinforced PVC hose



## Colored PVC Drain / General Purpose Tubing

General purpose, industrial grade PVC tube provides lightweight flexibility, kink resistance and economy.

Part Number	Tube ID" x OD"	Std. Package	Clamp	Additional Information
215-06100-00	3/8 x 5/8	100' payout carton	15.7	Gray
215-08120-00	1/2 x 3/4	100' payout carton	19.8	Gray
215-10140-00	5/8 x 7/8	100' boxed coil	22.6	Gray
215-12160-00	3/4 x 1	100' boxed coil	27.1	Gray
213-10140-00	5/8 x 7/8	100' boxed coil	22.6	Black
213-12160-00	3/4 x 1	100' boxed coil	27.1	Black
213-16200-00	1 x 1-1/4	100' wrapped coil	33.1	Black
213B-1216x100	3/4 x 1	100' boxed coil	27.1	Blue

## Sani-Clean AM™ Drain Tubing

Proprietary anti-microbial additive discourages fungal growth on the inner and outer surfaces. Translucent metallic gray color looks sanitary while allowing visual inspection while in service. Ideal for ice machines, dispensing equipment, condensate drains, and wherever protection from microorganisms is needed.



Part Number	Tube ID" x OD"	Std. Package	Clamp
218-0610x100	3/8 x 5/8	100' payout carton	17.0
218-0812x100	1/2 x 5/8	100' payout carton	19.8
218-1014x100	5/8 x 7/8	100' boxed carton	22.6
218-1216x100	3/4 x 1	100' boxed carton	27.1
218-1620x100	1 x 1-1/4	100' boxed carton	33.1

## Tigerflex™ Drain Hose

Tigerflex has smooth bore flexible PVC to minimize internal flow restrictions, with rigid PVC helix reinforcement to provide exceptional kink resistance and a very tight bend radius for difficult installations. Tigerflex is generally used on ice maker and beverage dispenser drains.

Insulated Tigerflex is ideal for under-the-counter and fountain head areas because it keeps condensation from forming on the drain hose and then dripping on the floor. Antimicrobial insulation inhibits the growth of bacteria and other micro-organisms. Snug fitting insulation minimizes air entrapment beneath the insulation and condensation that might otherwise form. Insulated hoses are furnished in nominal 72" lengths. Service Temperature: -4° to 150° F.



Tigerflex with anti-microbial insulation



Tigerflex without insulation

Part Number	Hose ID" x OD"	Std. Pkg.	Clamp	Additional Information
A15-DHG50MM	1/2 x 11/16	72"	19.8	Antimicrobial insulation
A15-DHG20MM	3/4 x 1-1/16	72"	27.1	Antimicrobial insulation
A15-DHG27MM	1 x 1-3/8	72"	34.6	Antimicrobial insulation
DHG05MMX100	1/2 x 11/16	100'	19.8	Non-insulated
DHG20MMX100	3/4 x 1-1/16	100'	27.1	Non-insulated
DHG27MMX100	1 x 1-3/8	100'	34.6	Non-insulated

## Beer Hose Assemblies

Part Number	Description
08-0560	Keg transfer lead, Masterflex 5/16" ID x 1/2" OD
CPCCM101	Jumper line pre-made 5' of 3/16" clear beer hose with hex nut fittings on one end
CPCCM102	Jumper line pre-made 5' of 3/16" clear beer hose with hex nut fittings on both ends
CPCCM103	Jumper line pre-made 5' of 3/8" beer hose with hex nut fittings on both ends
CPCCM104	Jumper line pre-made 5' of 1/4" beer hose with 1/4" MFL to hex nut fitting



Hex nut jumper line both ends



Hex nut jumper line

08-0560

## Metal Tubing

Part Number	Description	Std. Length
0375020304096	3/8" OD stainless steel	300'
940004	5/16" stainless steel	10,000' coil
CPTUBE-4	1/4" OD copper	50' coil
CPTUBE-5	5/16" OD copper	50' coil
CPTUBE-6	3/8" OD copper	50' coil



CPTUBE



0375020304096

## Tubing Tools

Part Number	Description
29	Vice grip pinch-off tool
14100387	Pincer, side jaw, compound action HIP 2800 E
P-02	Side jaw pincers
C100	Standard pincers
C200	SS tube ID sizing rod: 3/16, 1/4, 5/16, 3/8"
951-01	Bundle jacket slicer
953-01000-00	Jumbo bundle cutter, cuts 2.5" diameter bundles
954-01	Bundle tubing cutter
958-01	Hose cutter
959-01	Accu-cutter



14100387



C200 tube sizing rod



C100



959-01



P-02



29



953-01000-00



954-01



951-01



958-01

## Metal Hose Clamps



Part Number	Description	Inch Range
62602	Adjustable hose clamp	1/4 - 5/8
435032E	Adjustable hose clamp	3/8 - 7/8
HC5212	Adjustable hose clamp	1/2 - 1-1/4
600024	Adjustable hose clamp	1-1/16 x 2
600040	Adjustable hose clamp	2-1/16 x 3
600056	Adjustable hose clamp	3-1/16 x 4

## Plastic Hose Clamps



Part Number	Nominal OD"	Description
17007	7/16	Plastic hose clamp, white
17019	1/2	Plastic hose clamp, yellow
170211	9/16	Plastic hose clamp, red
170312	5/8	Plastic hose clamp, black
170415	3/4	Plastic hose clamp, blue

## Tapes



Part Number	Description
ME1795	Teflon tape
ME1985	Black electrical tape, 66 ft. roll
ME7015200	Silver duct tape
NA398B	Black duct tape
4219-12	Foam insulation tape, 2" x 30'
504189	Tape, black, PVC, 3" x 60'
MP100820	Sleeve (4 rolls) 2" x 60' vinyl tape

## Lubricants

Part Number	Description
4084-03	Food Grade Silicone spray
FT101L	1 oz. tin/can lubricant
FT938	8 oz. tin/can lubricant
95-0231	Food grade lubricant
HLFT	Food grade lubricant, 4 oz tube



4084-03



HLFT



95-0231



FT101L



FT938

## PVC Raceway

Keep tubing clean, neatly organized and out of harm's way with PVC raceway. Slotted for easy access to tubes.



F4X4WH6



C4WH6

Part #	Description
C4WH6	Raceway cover, white PVC 4" x 6'
F4X4WH6	Raceway, white PVC 4" x 4" x 6' slotted

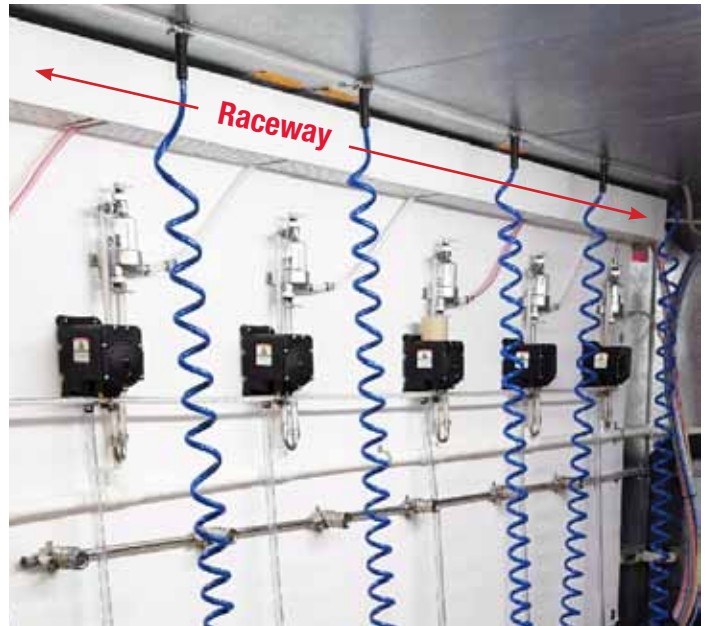

Beer Systems, Bar Equipment

## Equipment Mounting Boards



Part #	Size"	Description
18-0348	7" x 12"	Equip. mounting board, galvanized
18-0349	7" x 18"	Equip. mounting board, galvanized
18-0350	7" x 24"	Equip. mounting board, galvanized
18-0351	12" x 12"	Equip. mounting board, galvanized
18-0352	12" x 18"	Equip. mounting board, galvanized
18-0353	12" x 24"	Equip. mounting board, galvanized
97-0212	8' x 4' x 1/2"	Manifold board, white Nycel

## Air Cooling Components

Part #	Description
ES-265-3A	Blower assembly with bracket, 273 CFM
BE-1630-4	Flexible aluminum duct 4"OD



ES-265-3A



BE-1630-4

## Stainless Steel Chase

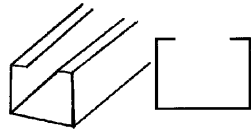

Part #	Size"	Description
608237	2.5 x 2.5 x 72	Chase, lid and hardware
608688	3 x 3 x 72	Chase, lid and hardware
608628	3 x 3 x 95	Chase with hardware
629915	4 x 4 x 48	Chase, lid and hardware
629919	4 x 4 x 72	Chase, lid and hardware
608622	6 x 6 x 72	Chase, lid and hardware
609623	6 x 6 x 78	Chase, lid and hardware
629916	6 x 6 x 95	Chase, lid and hardware
600108	6 x 6 x 108	Chase, lid and hardware
608625	6 x 8 x 72	Chase, lid and hardware
629917	6 x 10 x 95	Chase, lid and hardware

*Beer line saddles can be found with fittings on page 111*

## Conduit Straps

Fasten tubing to walls or ceilings.

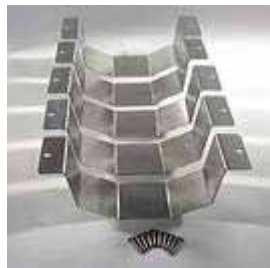

205968

Part #	Size"	Description
HS907	2-1/2	Conduit strap (2 hole)
HS909	3-1/2	Conduit strap (2 hole)
205968		Stainless conduit straps, 5 straps and mounting screws

## Kwik Blocks

Quick and secure way to fasten tubing to 2x4 or 2x6 studs, black or natural. Sold in cases of 100 or individually.



Part #	Description	Size L x W x H"
KB5400	Large, side mounting ears, for 2x6	5-3/8 x 2-1/4 x 1-7/8
KB3000	Small, side mounting ears	3 x 1-1/8 x 1
KB3400	Large, single center hole, no ears for 2x4 stud	3-3/8 x 2-1/4 x 1-7/8
KB2000	Small, single center hole, no ears	2 x 1-1/8 x 1

## Backflow Preventing TRU-GAP Kits

When you cannot connect directly to your drain system and need to allow proper air gap, Tru-Gap is the perfect solution. It's designed for draining beverage dispensers, ice maker, filtration system and many other uses.

- Multiple installation configurations for different applications
- Can be connected by solvent weld glue to standard 2" PVC pipe
- Optional PVC reducer fittings can be adapted to smaller or larger piping easily
- Includes built in hook for floor grates & drains
- Helps prevents backed-up and potentially contaminated water from entering your system
- Ideal for a number of applications such as dish washers, beverage machines, eye-wash stations, ice machines, filtration systems, buffet tables, and many more applications
- Included pipe mount secures pipes and prevents them from wobbling or sagging also provides a clean and professional appearance
- Tested and fully compliant to the ASTM D2665-07 standard

Drain body and tubing support mount are (PVC) ASTM D2665, hardware is stainless steel.

Installation: TRU-GAP can be connected by solvent weld to a standard 2" PVC DWV pipe, and with PVC reducer fittings can be adapted to smaller or larger piping.

Part #	Description
925340	Tru-Gap air gap fixture with pipe mount
925341	Tru-Gap pipe mount

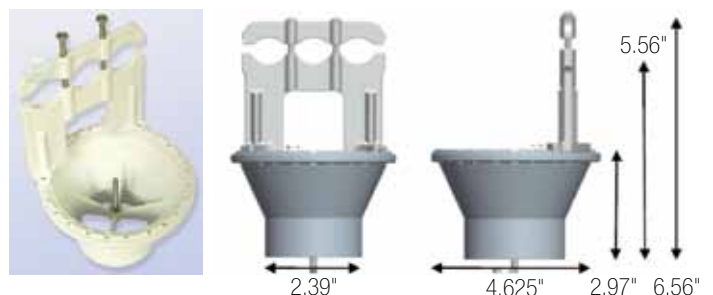

## Armaflex® Pipe Insulation

Helps control temperature, condensation and mold and mildew growth. Sold in 6' sections.



Part Number	ID"	Thickness"	Std. Package
3/8X3/8W	3/8	3/8	600 linear feet
3/8X1/2W	3/8	1/2	450
3/8X3/4W	3/8	3/4	240
1/2X3/8W	1/2	3/8	480
1/2X1/2W	1/2	1/2	396
1/2X3/4W	1/2	3/4	210
5/8X3/8W	5/8	3/8	390
5/8X1/2W	5/8	1/2	300
5/8X3/4W	5/8	3/4	144
5/8X1W	5/8	1	120
3/4X3/8W	3/4	3/8	330
3/4X1/2W	3/4	1/2	240
3/4X3/4W	3/4	3/4	138
3/4X1W	3/4	1	90
7/8X3/8W	7/8	3/8	270
7/8X1/2W	7/8	1/2	210
7/8X3/4W	7/8	3/4	120
7/8X1W	7/8	1	90
1-1/8X3/8W	1-1/8	3/8	210
1-1/8X1/2W	1-1/8	1/2	150
1-1/8X3/4W	1-1/8	3/4	90
1-1/8X1W	1-1/8	1	72
1-3/8X3/8W	1-3/8	3/8	180
1-3/8X1/2W	1-3/8	1/2	120
1-3/8X3/4W	1-3/8	3/4	72
1-3/8X1W	1-3/8	1	60
1-5/8X3/8W	1-5/8	3/8	120
1-5/8X1/2W	1-5/8	1/2	90
1-5/8X3/4W	1-5/8	3/4	60
1-5/8X1W	1-5/8	1	48
2-1/8X3/8W	2-1/8	3/8	96
2-1/8X1/2W	2-1/8	1/2	60
2-1/8X3/4W	2-1/8	3/4	54
2-1/8X1W	2-1/8	1	36
2-5/8X3/8W	2-5/8	3/8	72
2-5/8X1/2W	2-5/8	1/2	60
2-5/8X3/4W	2-5/8	3/4	48
2-5/8X1W	2-5/8	1	36
3-1/8X3/8W	3-1/8	3/8	54
3-1/8X1/2W	3-1/8	1/2	42
3-1/8X3/4W	3-1/8	3/4	36
3-1/8X1W	3-1/8	1	30
3-5/8X1/2W	3-5/8	1/2	36

Part Number	ID"	Thickness"	Std. Package
3-5/8X3/4W	3-5/8	3/4	30 linear feet
3-5/8X1W	3-5/8	1	24
4-1/8X1/2W	4-1/8	1/2	24
4-1/8X3/4W	4-1/8	3/4	24
4-1/8X1W	4-1/8	1	18
5/8X1/2WSS	5/8	1/2	300
5/8X3/4WSS	5/8	3/4	144
5/8X1WSS	5/8	1	120
3/4X1/2WSS	3/4	1/2	240
3/4X3/4WSS	3/4	3/4	138
3/4X1WSS	3/4	1	90
7/8X1/2WSS	7/8	1/2	210
7/8X3/4WSS	7/8	3/4	120
7/8X1WSS	7/8	1	90
1-1/8X1/2WSS	1-1/8	1/2	150
1-1/8X3/4WSS	1-1/8	3/4	90
1-1/8X1WSS	1-1/8	1	72
1-3/8X1/2WSS	1-3/8	1/2	120
1-3/8X3/4WSS	1-3/8	3/4	72
1-3/8X1WSS	1-3/8	1	60
1-5/8X1/2WSS	1-5/8	1/2	90
1-5/8X3/4WSS	1-5/8	3/4	60
1-5/8X1WSS	1-5/8	1	48
2-1/8X1/2WSS	2-1/8	1/2	60
2-1/8X3/4WSS	2-1/8	3/4	54
2-1/8X1WSS	2-1/8	1	36
2-5/8X1/2WSS	2-5/8	1/2	60
2-5/8X3/4WSS	2-5/8	3/4	48
2-5/8X1WSS	2-5/8	1	36
3-1/8X1/2WSS	3-1/8	1/2	42
3-1/8X3/4WSS	3-1/8	3/4	36
3-1/8X1WSS	3-1/8	1	30
3-5/8X1/2WSS	3-5/8	1/2	36
3-5/8X3/4WSS	3-5/8	3/4	30
3-5/8X1WSS	3-5/8	1	24
4-1/8X1/2WSS	4-1/8	1/2	24
4-1/8X3/4WSS	4-1/8	3/4	24
4-1/8X1WSS	4-1/8	1	18



## Cable Ties

All cable ties are priced per 100 and sell by the bag quantity.



Mini, standard, heavy duty, extra heavy duty ties



Screw mounts



Cable clamps



Cable tie mounts

	Part #	Size"	Color	Tensil	Bag Qty	
<b>Mini</b>	CT4-18C9	4	Natural	18	100	
	CT4-18COW	4	UV Black	18	100	
	CT5-18C9	5.5	Natural	18	100	
	CT5-18COW	5.5	UV Black	18	100	
	CT8-18C9	8	Natural	18	100	
	CT8-18COW	8	UV Black	18	100	
	CT8-50C9	8	Natural	08436-1	100	
	CT8-50COW	8	UV Black	50	100	
<b>Standard</b>	CT11-50C9	11	Natural	50	100	
	CT11-50M9	11	Natural	50	1,000	
	CT14-50C9	14.5	Natural	50	100	
	CT14-50COW	14.5	UV Black	50	100	
	CT17-50C9	17	Natural	50	100	
	CT17-50COW	17	UV Black	50	100	
	CT24-50C9	24	Natural	50	100	
	CT24-50COW	24	UV Black	50	100	
	CT36-50K9	36	Natural	50	50	
	CT36-50COW	36	UV Black	50	50	
	<b>Heavy Duty</b>	CT8-120C9	8	Natural	120	100
		CT8-120COW	8	UV Black	120	100
		CT11-120C9	11	Natural	120	100
		CT11-120COW	11	UV Black	120	100
		CT14-120C9	14.5	Natural	10038-0	100
		CT14-120COW	14.5	UV Black	120	100
CT17-120C9		17	Natural	120	100	
CT17-120COW		17	UV Black	120	100	
CT17-175C9		17	Natural	175	100	
CT17-175COW		17	UV Black	175	100	
CT21-120C9		21	Natural	120	100	
CT21-120COW		21	UV Black	120	100	
CT21-175K9		21	Natural	175	50	
CT21-175KOW		21	UV Black	175	50	
CT24-175K9		24	Natural	175	50	
CT24-175KOW		24	UV Black	175	50	
CT32-175K9	32	Natural	175	50		
CT36-175KOW	36	UV Black	175	50		
CT48-175K9	48	Natural	175	50		
CT48-175KOW	48	UV Black	175	50		

	Part #	Size"	Color	Ref.	Bag Qty	
<b>Extra Heavy Duty</b>	CT9-250X9	9	Natural	250	25	
	CT9-250XOW	9	UV Black	250	25	
	CT18-250X9	18.5	Natural	250	25	
	CT18-250XOW	18.5	UV Black	250	25	
	CT23-250X9	23	Natural	250	25	
	CT23-250XOW	23	UV Black	250	25	
	CT29-250X9	29	Natural	250	25	
	CT29-250XOW	29	UV Black	250	25	
	CT35-250X9	35	Natural	250	25	
	CT35-250XOW	35	UV Black	250	25	
	CT40-250X9	40	Natural	250	25	
	CT40-250XOW	40	UV Black	250	25	
	<b>Screw Mounts</b>	CTM4-18C9	4	Natural		100
		CTM4-18COW	4	UV Black		100
		CTM6-40C9	6	Natural	08484-1	100
		CTM6-40COW	6	UV Black		100
CTM8-50C9		8	Natural	509912	100	
CTM8-50COW		8	UV Black		100	
CTM11-50C9		11	Natural	10350	100	
CTM11-50COW		11	UV Black		100	
CTM14-50C9		14.5	Natural	10035-0	100	
CTM14-50COW		14.5	UV Black		100	
CTM15-120C9		15	Natural		100	
CTM15-120COW		15	UV Black	SM038W120KC	100	
<b>Cable Clamps</b>		CC5-1/8	1/8	Natural		100
		CC5-1/4	1/4	Natural		100
		CC5-3/8	3/8	Natural		100
		CC5-1/2	1/2	Natural		100
	CC5-9/16	9/16	Natural		100	
	CC5-3/4	3/4	Natural		100	
	CC5-7/8	7/8	Natural		100	
	CC5-1-1/8	1-1/8	Natural		100	
	<b>Cable Tie Mnts</b>	ACMB50C	1/2	Natural		100
		ACMB50C-0	1/2	UV Black		100
ACMB75C		3/4	Natural		100	
ACMB75C-0		3/4	UV Black		100	
ACMB11C		1.1	Natural		100	
ACMB11C-0		1.1	UV Black		100	

## Line Labels and Clips

Line markers clamp onto tubing and identify each line, which helps prevent mistakes when connecting new pumps, tubing, and BIB boxes. Line marker decals have 5 decals per sheet: line marker, pump, rack and two Flojet end caps. Labels for all major soft drink and beer brands, Air, CO<sub>2</sub> Gas, Nitrogen, Carb Water, Soda Water, Water, and blank (create your own label) are available.

*A complimentary Flavor Identification Label Packet is included with each new BIB rack!* Each kit contains 10 line maker clips for the 3/8" BIB syrup inlet tubes, 1 line marker clip for the 1/4" braided CO<sub>2</sub> line and an assortment of 10 popular flavor label sheets.

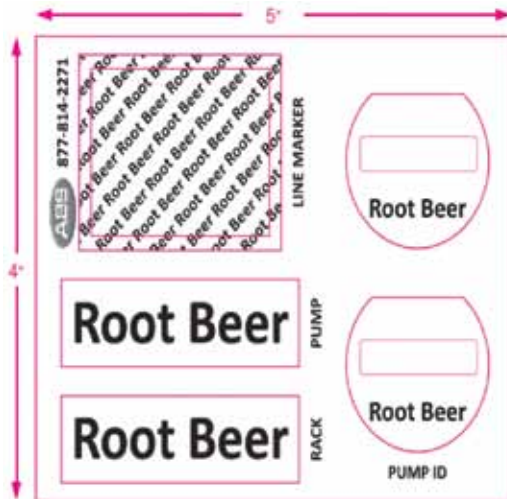

Flavor label sheet sample



Line clamp

Part Number	Marker Clip Size	Tubing Size
SM-4103	Small	1/4" poly tubing / 1/4" braided hose
SM-8304	Medium	3/8" poly tubing
SM-8301	Large	3/8" BIB tubing / 3/8" braided hose
SM-2102	Extra large	1/2" braided hose

Part #	Description	Part #	Description
FLS001	7UP	FLS047	Mtn Dew Code Red
FLS002	AIR	FLS048	Mountain Dew Diet
FLS003	Apple Juice	FLS049	Mug Root Beer
FLS004	Barq's Red Crème	FLS050	Orange
FLS005	Barq's Root Beer	FLS051	Orange Diet
FLS006	Birch Beer	FLS052	Orange Juice
FLS007	Blank	FLS053	Orange Soda
FLS008	Caf Free Diet Coke	FLS054	Orange Soda Diet
FLS009	Cherry	FLS055	Peach
FLS010	Cherry Coca-Cola	FLS056	Pepsi
FLS011	Cherry Coca-Cola Zero	FLS057	Pepsi Caffeine Free Diet
FLS012	Cherry Limeade	FLS058	Pepsi Diet
FLS013	Club Soda	FLS059	Pepsi Wild Cherry
FLS014	CO2 GAS	FLS060	Pineapple
FLS015	CO2 Water	FLS061	Pink Grapefruit
FLS016	Coca-Cola	FLS062	Pink Lemonade
FLS017	Cola	FLS063	Powerade Fruit Punch
FLS018	Cranberry	FLS064	Powerade Lemon-Lime
FLS019	Diet Coke	FLS065	Powerade Mtn Blast
FLS020	Diet Coke w/ Lime	FLS066	Raspberry Ice Tea
FLS021	Dr Pepper	FLS067	RC Cola
FLS022	Dr Pepper Diet	FLS068	RC Cola Diet
FLS023	Fresca	FLS069	Root Beer
FLS024	Fruit Punch	FLS070	Root Beer Diet
FLS025	Gatorade Cool Blue	FLS071	Sierra Mist
FLS026	Gatorade Fruit Punch	FLS072	Sierra Mist Diet
FLS027	Gatorade G2 Fruit Punch	FLS073	Soda
FLS028	Gatorade Lemon Lime	FLS074	Soda Water
FLS029	Gatorade Orange	FLS075	Sprite
FLS030	Gatorade Rain Cherry	FLS076	Sprite Zero
FLS031	Gingerale	FLS077	Squirt
FLS032	Grape	FLS078	Squirt Ruby Red
FLS033	Grapefruit	FLS079	Strawberry
FLS034	Green Tea	FLS080	Tahitian Treat Fruit Punch
FLS035	Hawaiian Punch	FLS081	Tea
FLS036	Kiwi Strawberry	FLS082	Tea Lemon
FLS037	Lemonade	FLS083	Tea Unsweet
FLS038	Lipt Brsk Joy Pch Gm Tea	FLS084	Tonic
FLS039	Lipt Brsk Lemon Iced Tea	FLS085	Trop Fruit Punch
FLS040	Lipton Brisk Lemonade	FLS086	Trop Lemonade
FLS041	Lipt Brsk Peach Iced Tea	FLS087	Trop Lemonade Sugar Free
FLS042	Lipt Brsk Rasp Iced Tea	FLS088	Trop Pink Lemonade
FLS043	Lipt Brsk Sweet Iced Tea	FLS089	Trop Twister Orange Soda
FLS044	Lipt Brsk Unsweet Iced Tea	FLS090	Vanilla Coke
FLS044	Tea	FLS091	Vernors
FLS045	Mello Yello	FLS092	Vernors Diet
FLS046	Mountain Dew	FLS093	Water

## Blendtec® Commercial Blenders/Dispensers

Forget the ice scoops and measuring cups. Blendtec Dispensers includes everything necessary for your complete blended drink program. With the touch of a few buttons, employees will quickly and perfectly blend dozens of high-margin smoothies, coffee treats and alcoholic drinks like margaritas and daiquiris. No scooping, no measuring, no problem!

Blendtec high volume blenders are among the quietest and most powerful on the planet, and their jars are built to handle high-speed impacts from very hard ingredients like frozen fruit. Blendtec blunt blades are made of cold-forged hardened steel and are up to 80% thicker and 10 times stronger than other blender blades, and safer to clean. With a blade that spins over 300 miles per hour, it doesn't need to be sharp to pulverizes virtually anything.

The self serve smoothie machine has an integrated ice machine that makes up to 400 lbs. in 24 hours. It also cleans and sanitizes the dispensing lines, keeping the product flowing properly and consistently producing quality drinks. An illuminated LCD display provides instructions and status. An optional front monitor provides ad space to announce store specials or other promotions.

The BDI and BD8 can add and blend up to 8 bag-in-box concentrates automatically. Ingredients other than ice and water are added manually to the BI.

Modern touch controls enable walk-away blending. BDI, BI and BD8 units have flat panel interfaces, blue LCD displays and USB ports for easy programming changes. The sound dampening enclosure provides a quieter, more pleasant environment for employees and customers.



BDI



BI



BD8

Part #	Model	Dispenses & Blends	Drink Blends	Ice Capacity	Motor	Size W x D x H"
BDI-503-01	BDI	BIB concentrate, ice & water	64	Hopper: 25 lbs	3.8 HP	12 x 21 x 32
BI-503-01	BI	Ice & water	64	Hopper: 25 lbs	3.8 HP	12 x 21 x 32
D8-501-01	BD8	BIB concentrate & water	64	N/A	3.8 HP	19 x 14 x 21

## Blendtec® Commercial Blenders

Industry-leading power and a wide range of state-of-the-art features are designed to ensure speed, consistency, and quality with each and every order. All conform to applicable UL and CSA safety standards as well as NSF sanitation standards. 3 year warranty.



### Stealth 875

- Winner of the National Restaurant Association's prestigious 2013 Kitchen Innovations Award
- Sleek sound enclosure, proprietary sound dampening and airflow innovations
- In addition to 42 preprogrammed cycles, users can create custom blends with the online Blend Wizard™, then store up to 14 on the blender for one-touch operation using the USB port
- Users can create custom drink programs with the online BlendWizard™ which can create an unlimited number of blend cycles, and up to 14 can be stored on the blender
- Illuminated control surface with speed slider, LED display
- 11-speed capacitive touch slider provides precision speed control and pulse button adds a burst of power
- Recommended daily blends: 200+
- Motor: 3.8 peak horsepower, 1875 watts, 15 amps
- Low profile in-counter model is also available

### Stealth 885

- The Stealth 885 combines all of the durability, power, and wealth of features of the Stealth 775, plus a tactile touch pad

### Stealth 895 NBS (Nitro Blending System)

- Blends right in the cup you give your customer
- Minimizes waste, saves time, and increases profit margin
- 6 preprogrammed cycles, including two customized for the NBS attachment

### Connoisseur 825

- Create custom drink programs with the online BlendWizard™ which can create an unlimited number of blend cycles, up to 6 can be stored on the blender
- Sleek sound enclosure
- 30 preprogrammed cycles + pulse
- Recommended daily blends: 150+
- Motor: 3.8 peak horsepower, 1875 watts, 15 amps

### Chef 600

- One-touch controls designed for culinary chefs
- Each setting runs at a consistent speed and can be shut off manually or automatically after 90 seconds
- Motor: 3.0 peak horsepower, 1560 watts, 13 amps
- Recommended daily blends: 60+
- Speeds: Low, Medium, High
- Low and High Pulse

### EZ 600

- Motor: 3.0 peak horsepower, 1600 watts, 13 amps
- Recommended daily blends: 60+
- Program cycles: Small, Medium, Large + Pulse
- Profiles: Smoothies, Coffee, Milkshake

## Blendtec® Commercial Blenders



Part Number	Model	Color	Blends/Day	Jars	Lid	Sound Enclosure
S875C2901-B1GB1D	Stealth 875	Black	200+	2 WildSide+	Soft lid	Yes
S875C2901-B1GB1A	Stealth 875	Black	200+	FourSide	Soft lid	Yes
S875C2901-NOJAR	Stealth 875	Black	200+	No Jar	No lid	Yes
I875C2901-B1GB1D	Stealth 875*	Black	200+	2 WildSide+	Soft lid	Yes
S885C2901-B1GB1D	Stealth 885	Black	200+	2 WildSide+	Soft lid	Yes
S885C2901-B1GB1A	Stealth 885	Black	200+	FourSide	Soft lid	Yes
S885C2901-NOJAR	Stealth 885	Black	200+	No Jar	No lid	Yes
SNBSC2901-NITRO	Stealth 895 NBS	Black	N/A	N/A	N/A	Yes
C825C11Q-B1GB1D	Connoisseur 825	Black	150+	2 WildSide+	Soft lid	Yes
C825C11Q-B1GB1A	Connoisseur 825	Black	150+	2 FourSide	Soft lid	Yes
C825C11Q-NOJAR	Connoisseur 825	Black	150+	No Jar	No lid	Yes
C600A0801-A1GA1A	Chef 600	Black	60+	FourSide	Gripper	No
E600A0801-A1GA1A	EZ 600	Black	60+	FourSide	Gripper	No



**WildSide+, FourSide and Twister jars** are BPA-free Eastman Tritan™ copolyester, lightweight for easy lifting and pouring, and have jar markings in oz. and ml. Three pour corners allow pouring at multiple angles. Blunt safety blades are 10 times stronger than traditional blades. Jars come with a vented Gripper™ lid, hard lid or soft lid. Custom jar colors and graphics are available.

- WildSide+ has a patented 5-sided jar that produces a better blending vortex, and the blade is nearly 4" long
- The Twister Jar has a twisting lid to scrape the jar sides while blending thick recipes; nut butters, hummus, thick shakes, dressings and more

**Exploded view diagrams and parts lists are shown in Replacement Parts, section G, pages 98-107**

Part Number	Description
40-609-60	Clear Fourside jar with vented gripper lid
40-609-61	Clear Fourside jar with soft lid
40-609-62	Clear Fourside jar with hard lid
40-618-62	Yellow Fourside jar with hard lid
40-619-62	Red Fourside jar with hard lid
40-620-65	Clear Twister jar and lid
40-630-60	Clear WildSide+ jar with vented gripper lid
40-630-61	Clear WildSide+ jar with soft lid
40-630-62	Clear WildSide+ jar with hard lid
40-636-62	Yellow WildSide+ jar with hard lid
40-637-62	Red WildSide+ jar with hard lid

Jars are also available in 2, 5 and 10 packs.

## Blendtec® Commercial Blenders



Part Number	Description
40-210-02-SRV	Soft lid, 10 pack
40-209-01-SRV	Hard lid, 10 pack
40-303-SRV	Vented gripper lid, 10 pack
40-209-03-SRV	Red hard lid, 10 pack
SRV-831	Yellow hard lid
40-306-SRV	Twister scraper lid, 5 pack
28-601-01	Stealth sound enclosure
37-601	Connoisseur sound enclosure
32-204-01	In-counter gel pad gasket (sound enclosure) 10 pack
20-205/01	Motor base gasket 5 pack
21-203-SRV	Rubber feet, 20 pack
36-601-03	Connoisseur stand
41-601-01	Spectacula
41-601-02	Spoonula



The Rapid Rinse Station rinses jars with the push of a button, and conveniently provides space to drain and stack jars.

Part Number	Description
JRE-612	Rapid Rinse Station
JRE-610	Rapid Rinser
JRE-309	Hose assembly with quick valve release
SRV-669	Rapid Rinser service kit, little red rinser
10-117-03/01	Rapid Rinser service kit, 100 suction cups
21-203-SRV	Rubber feet, 20 pack



Rapid Rinse Station



## Omega™ Blenders

Equipped with various blending cycles and intuitive controls, Omega blenders create fast and fresh fusions of your favorite ingredients into creams, soups, smoothies and iced beverages with ease. Perfect for restaurants and juice bars!

### 300 Series

- Toggle control with high/low speed
- BPA free Tritan Copolyester container
- Available with unbreakable stainless steel container
- 2 oz (60 ml) cap for measuring and adding ingredients
- Recessed coupling system
- Self lubricating ball bearings
- Large metal cooling fan
- Heavy duty locking ring
- 2 Year warranty
- Approvals: UL listed

### 400 Series

- Unbreakable BPA Free Eastman® Tritan copolyester container
- Removable cap for adding ingredients
- Stainless steel blade assembly
- Automatic shutoff for overload protection
- No plunger needed
- Available in 120V/60Hz and 240V/50-60Hz
- Approvals: ETL Commercial, ETL Sanitation & CE

### 600 Series

- Touch pad and variable controls for precision blending
- Innovative Infinity Function for the perfect blend
- Unbreakable BPA free Eastman® Tritan copolyester container
- Removable cap for adding ingredients
- Stainless steel blade assembly
- Automatic shutoff for overload protection
- No plunger needed
- Approvals: ETL Commercial, ETL Sanitation



Model	BL330/BL360/BL390	BL420/BL430/BL460/BL470	BL630/BL660
Description	1 HP blender	3 peak HP blender	3 peak HP blender
Finish	Silver and Red	Silver	Silver, White or Red
Speed	21,500 - 25,500 RPM	Variable speed with pulse	Variable speed with timer and pulse
Controls	On/Off and High/Low toggle	420/430: On/Off and High/Low toggle 460/470: Variable speed with pulse	Infinity controls
Container Type, Capacity	330: Copolyester, 48 oz 360: Stainless steel, 32 oz 390: Copolyester & SS	420/460: Copolyester, 64 oz 430/470: Copolyester, 82 oz	630: Copolyester, 64 oz 660: Copolyester, 82 oz
Power	600 watts	1500 watts	1400 watts
Voltage	120V/60Hz	120V/60Hz	220V/50Hz
Size	6-1/4W x 8-1/4D x 15-3/4"H	460: 7-3/4W x 9D x 18-1/4"H 470: 7-3/4W x 9D x 20-1/4"H	630: 8W x 8D x 19"H 660: 8W x 8D x 20.5"H
Weight	6.5 lb / 3 kg	15 lb / 6.8 kg	11.5 lb / 5.2 kg
Optional Voltage	240V/50Hz	240V/50-60Hz	N/A
Model Number	BL332/BL362/BL392	BL462/BL472	

## Omega Juicers



J8008



J8007



NC900HDC



NC800HDS



J8006



J8004



VRT400



VRT380



VRT370



VRT350

Model	J8004/J8006/J8007/J8008	NC800HDS/NC900HDC	VRT350/VRT370/VRT380/VRT400
Finish	J8004: white J8006: chrome J8007: silver J8008: chrome	NC800HDS: silver NC900HDC: chrome	VRT350S: satin VRT350W: white VRT370HDS: silver VRT380HDC: chrome VRT400HDS: silver
Motor	1/3HP, gear reduction equivalent of 2HP	Gear reduction equivalent of 2HP	VRT350/VRT400: 1/5HP condensed motor VRT370/VRT380: 1/4HP condensed motor
Speed	80 RPM	80 RPM	80 RPM
Voltage	110-120V/60Hz	110-120V/60Hz	110-120V/60Hz
Wattage	J8004/J8006: 150 watts J8007/J8008: 200 watts	150 watts	VRT350/VRT400: 150 watts VRT370: 200 watts
Size	6.5" W x 14.5" D x 15.5" H	6.5" W x 14.5" D x 15.5" H	7" W x 8.5" D x 15.5" H
Weight	20 lbs	13 lbs	22 lbs
Optional Voltage	220V/50-60Hz	220V/50-60Hz	220V/50-60Hz
Warranty	15 years	15 years	VRT350/VRT370/VRT380: 10 years VRT400HDS: 15 years





## Icy Shot Liquor Chiller

Patented instant chilling system (without reservoirs) eliminates the need for ice cubes which retains the organoleptic properties of the drink. Dispensing temperature can be set to your own taste, as low as -0.4° F, using the digital thermostat. Deluxe models, each spout independently dispenses a preset portion, and changing the preset portions is fast and easy. Universal adapters allow use of any kind of bottle. Cleaning is easy! Simply insert a bottle filled with lukewarm and dispense for a few minutes. Customization and branding is available. Plug and play units, no installation is required.



Icy Shot



Part #	Description
011449	Icy Shot basic with LED lights, 1 bottle, 115V/60Hz
011006	Icy Shot basic with LED lights, 1 bottle, 230V/50Hz
010609	Icy Shot deluxe with LED lights, digital display, portion control, 1 bottle, 115V/60Hz
010920	Icy Shot deluxe with LED lights, digital display, portion control, 1 bottle, 230V/50Hz
000154	Icy Shot basic with LED lights, 2 bottles, 115V/60Hz
000015	Icy Shot basic with LED lights, 2 bottle, 230V/50Hz
012157	Icy Shot deluxe with LED lights, digital display, portion control, 2 bottle, 230V/50Hz
008582	Icy Shot deluxe with LED lights, digital display, portion control, 3 bottles, 115V/60Hz
008581	Icy Shot deluxe with LED lights, digital display, portion control, 3 bottles, 230V/50Hz

1 and 2 bottle units have printable/customizable shells

Part #	Description
1FL-PERS	Single flavor unit personalization - upcharge per machine
2FL-PERS	Dual flavor unit personalization - upcharge per machine
SETUP	Icy Shot personalization tooling - one time charge



## Unicorn™ Soda Dispensing Towers

Designed with a sleek retro look, the Unicorn font adds character and style to your bar or restaurant dining experience. Products can be served with pinpoint accuracy by pulling the handle, holding the flavor button, or by the optional portion control buttons. Accommodates up to four brands and carbonated water. Features Lancer Flow Control Valve Recirculation (LFCV-R), 1.75 oz/sec. Through counter mounting. Drip tray included. Carbonated water inlet: 3/8" quick disconnect. Syrup inlets: 1/4" barb. 24V/60Hz. Options: Power supply, chiller, and branding



**Additional soda dispensers are shown in Dispensing and Ice, Section B**

Unicorn Tower:  
9.12"W x 14"D x 27.5"H  
Control Box (Valves):  
13.1"W x 8.12"D x 6.1"H  
Drip Tray Included

Part Number	Description
85-3161R-21-21222	Unicorn recirculating tower, portion control, LFCV-R valve, general beverage branding
85-3161R-21-23222	Unicorn recirculating tower, no portion control, LFCV-R valve, general beverage branding
85-9951Z-15	Delta 9100 remote chiller, 2 circuit recirculation, 16.9W x 24.75D x 25.5"H



Delta 9100 remote chiller

**Mark 4 Post-Mix Bar Guns**

Wunder-Bar Mark 4 bar guns have the following features for ease of service and greater reliability.

- Locking hat plugs allow for service to one valve cavity at a time. Plugs stay put, even under pressure.
- Optional shut-off screw extensions allow the shut-off screws to be turned off/on with finger and thumb. Includes cover guard. Order with or without this feature.
- Manifold end of flex-hose assembly now includes a welded stainless steel bushing, not plastic. Optional barrier tubing prevents flavor cross-over from pungent beverage syrups.
- Replace stem seal O-ring from the top of the handle, not the bottom, even under pressure. Retainer plate is removed, then O-ring.
- New shut-off screw includes soft-tip for positive shut-off

Black and white shut-off screws should be finger tightened only - **Tools may cause damage** - Turning screws past the "On" and "Off" positions may cause damage to the input module and cause leaking

- All handle heels now include split heel design.

- NEW Kwik Klip stays put. Won't pull out.

- Sanitary drip tray design catches any nozzle drip and provides sanitary air-gap from nozzle. Nozzle stays clean. New Wunder-Bar drip tray is NSF listed.



Cover guard removed

Cover guard in place



Old

New



10 button

12 button

14 button



Old  
New



## Mark 4 Bar Guns

The Wunder-Bar Mechanical Flex-Hose bar dispenser is available in 1, 2, 3, 4, 5, 6, 7, 8, 9, 10, 12, and 14 button models. All models can be configured for many combinations of carbonated, non-carbonated, non-carbonated pre-mix and energy drink products at any time. All of these combinations are field-convertible and can be modified without shutting off the dispenser. All seven, eight, and nine button dispensers have all the necessary valves and product tubes already installed into the dispenser, making the upgrade to up to ten buttons as easy as adding buttons on the handle and input modules and input fittings at the manifold.

Bar guns are available with permanent connections, quick disconnect or flow-regulated manifolds, optional barrier tubing, and in five colors. These units are field convertible from carbonated to non-carbonated and wine. Precision machined diffusers provide better carbonation, minimal brix stratification, faster flow rate and minimal foaming.

All Wunder-Bar post-mix type flex-hose dispensers include two water meter adjustment screws which allow 2:1 ratio products to be brixed independently from 4:1 or 5:1 ratios. No more sacrificing flow rates to obtain a 2:1 brix!

Bar guns include quick disconnect manifold, stainless steel input fittings, hose hanger and mounting hardware.

## Buttons and Butterfly Plates

The buttons and button plates can be removed while the dispenser is under pressure. After the button plate has been removed, buttons can be changed, as can the configuration of the dispenser. By removing the butterfly retainer and screws and lifting out the butterfly plates, various standard configurations and endless special configurations can be created. The butterfly plates' balls fit into indentations in the O-ring retainers located in the handle recess. The half moon cut out area of the butterfly plates are where the retainer and retainer screws are located when attaching the plates to the handle. When replacing butterfly plates, be careful not to overtighten the retainer screws. Over-tightening the retainer screws can cause the butterfly plates to bind.

*Butterfly plate configurations are detailed in the Replacement Parts section of this catalog.*



## Typical Post-Mix Bag-In-Box System

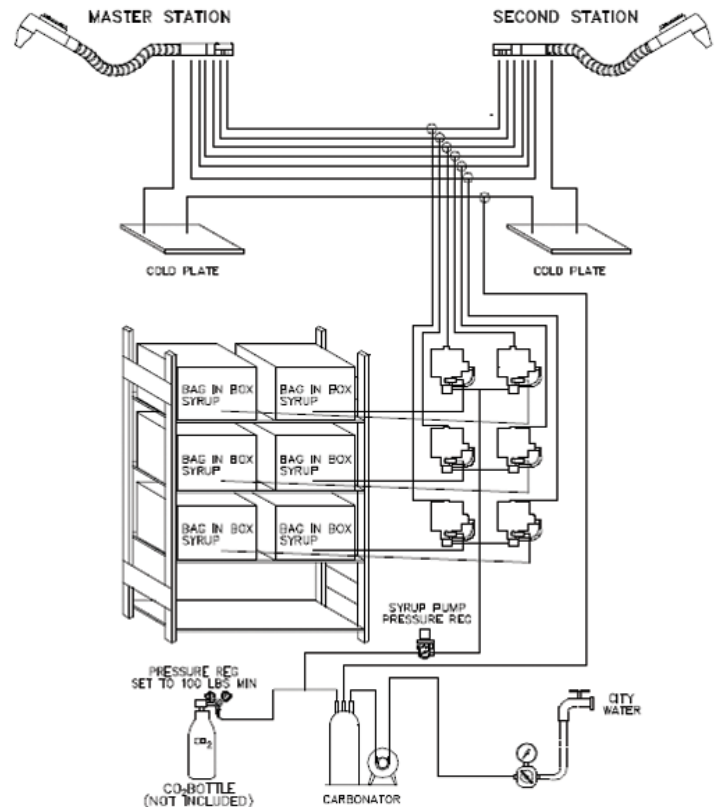

Standard manifold

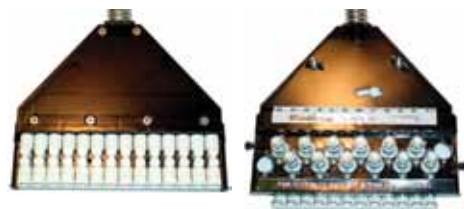

Flow regulated manifold

## Mark 4 Bar Guns

Wunder-Bar MARK 4 dispenser model numbers will begin with the M4 designation, followed by a dash. There will be no more dashes, unless the model includes NSF designation.

For example, an M410620KSM3 is a... MARK4, 10 button, 6 carbonated, 2 non-carbonated, zero pre-mix non-carbonated, black(K), Series 2.5 (S), metering screw manifold (M), 3 ft. hose length.

**The following charts explain model numbers. Underlined letters must be filled in with the desired options...**

The model number will not be affected if shut-off screw extensions are requested. Upon request they are included at no charge.

4 barrier lines are standard. Upon request 8 barrier lines are available at no cost, and are not part of the model number.

New dispensers ordered without instructions will include the new sanitary drip tray and hanger. However, old style drip cups and hangers are available upon request at no cost, and are not reflected in the model number.

### Post-Mix and Energy Drink Dispensers Model Numbers

<b>M4</b>	<b>a</b>	<b>b</b>	<b>c</b>	<b>d</b>	<b>e</b>	<b>f</b>	<b>g</b>	<b>h</b>	<b>(N)</b>
Mark 4 dispenser	Total # of buttons	Number of carbonated products	Number of non-carb products	Number of pre-mix non-carb products	Color: <b>K</b> = Black <b>R</b> = Red <b>B</b> = Blue <b>G</b> = Green <b>C</b> = Cabana blue	Type: <b>S</b> = std 2.5 <b>2</b> = Series II <b>3</b> = Series III (large soda/water tubing)	Manifold: <b>M</b> =metering screws <b>F</b> = flow reg. <b>FM</b> =flow reg + metering screws	Hose length: <b>3</b> = 3 ft. <b>4</b> = 4 ft. <b>5</b> = 5 ft. <b>6</b> = 6 ft.	Applies to NSF listed only (with plastic sheathing)

### Post-Mix Juice Dispensers\* Model Numbers

<b>M4</b>	<b>a</b>	<b>JD</b>	<b>e</b>	<b>f</b>	<b>h</b>	<b>(N)</b>
Mark 4 dispenser	Total # of buttons	Juice Dispenser	Color: <b>K</b> = Black <b>R</b> = Red <b>B</b> = Blue <b>G</b> = Green <b>C</b> = Cabana blue	Type: <b>S</b> = std 2.5 <b>2</b> = Series II <b>3</b> = Series III (large tubing)	Hose length: <b>3</b> = 3 ft. <b>4</b> = 4 ft. <b>5</b> = 5 ft. <b>6</b> = 6 ft.	Applies to NSF listed only (with plastic sheathing)

\*Juice dispensers are only available with metering screws.

## Please Note:

Mark 4 standard input module clip inserts should always be installed and kept in place on both sides of the Mark 4 standard input modules (input fitting and interconnect sides) **when the dispenser is under pressure**. (See fig. 1) These yellow clips ensure that the input module doesn't dislodge from the module frame. The clips should only be removed when servicing the manifold once the product (soda, water or syrup) has been depressurized or removed from the manifold position.

Also, it is important when mounting the dispenser that the manifold and the tube collector be mounted flush against the mounting surface using the (4) PM10-66 #10x2" that are provided with every dispenser in the hose hanger kit.

90° manifold block assemblies are available to assist in areas where tubing attachment or manifold/tube collector placement is difficult due to space constraints.

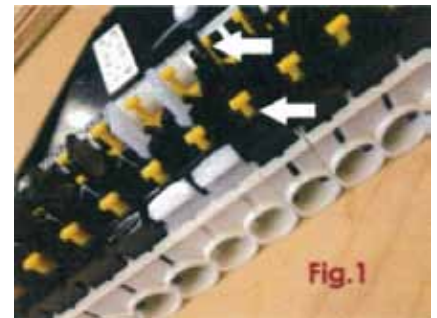

## Mark 4 Bar Guns

Please replace each asterisk (\*) with the appropriate number or letter to configure a new Mark 4 bar gun. Be sure to **USE THE PROPER SEQUENCE** detailed on page 68, and outlined below.

Post-Mix	Quick Disconnect
M48****M*	8 button dispenser, 6 flavors, soda and water
M410****M*	10 button dispenser, 8 flavors, soda and water
M412****M*	12 button dispenser, 10 flavors, soda and water
M414****M*	14 button dispenser, 12 flavors, soda and water
**** Specify number of carbonated, non-carb, pre-mix, accent color, disp., manifold (M), and hose length. Example: M410620KSM3 = 10 button, 6 carbonated, 2 non-carbonated, 0 pre-mix, black (K), Series 2.5 (S), metering screw manifold (M), 3 ft. hose length	
Accent Colors: K=Black, R=Red, B=Blue, G=Green, C=Cabana Blue	
Dispenser type: S=Standard (2.5), 2=Series II, 3=Series III	
Manifold type: M=metering screws	
Hose lengths: 3=3' (standard). Optional (upcharge): 4=4', 5=5', and 6=6'	
If NSF listed (with plastic sheathing) is desired, add (N) to the end of the part number	

Post-Mix	Flow Regulator (F) / Flow Regulator+Metering Screws (FM)
M48****F*	8 button dispenser, 6 flavors, soda and water, flow regulator
M410****F*	10 button dispenser, 8 flavors, soda and water, flow regulator
M412****F*	12 button dispenser, 10 flavors, soda and water, flow regulator
M414****F*	14 button dispenser, 12 flavors, soda and water, flow regulator
M48****FM*	8 button dispenser, 6 flavors, soda and water, flow regulator+metering screws
M410****FM*	10 button dispenser, 8 flavors, soda and water, flow regulator+metering screws
M412****FM*	12 button dispenser, 10 flavors, soda and water, flow regulator+metering screws
M414****FM*	14 button dispenser, 12 flavors, soda and water, flow regulator+metering screws
**** Specify number of carbonated, non-carb, pre-mix, accent color, type, manifold (M), and hose length. Example: M410620KSF3 = 10 button, 6 carbonated, 2 non-carbonated, 0 pre-mix, black (K), Series 2.5 (S), flow reg manifold (F), 3 ft. hose length	
Accent Colors: K=Black, R=Red, B=Blue, G=Green, C=Cabana Blue	
Dispenser type: S=Standard (2.5), 2=Series II, 3=Series III	
Manifold type: F=Flow reg., FM=Flow reg+Metering screws	
Hose lengths: 3=3' (standard). Optional (upcharge): 4=4', 5=5', and 6=6'	
If NSF listed (with plastic sheathing) is desired, add (N) to the end of the part number	

Energy Drink	Flex Hose
M41100KSM*	1 button energy drink dispenser
WBM2**	2 button energy drink dispenser
WBM3**	3 button energy drink dispenser
WBM4**	4 button energy drink dispenser
* Specify hose length: 3=3' (standard). Optional (upcharge): 4=4', 5=5', and 6=6'	
Accent color - BLACK only	

Post-mix and energy drink dispensers come with 1/4" SS inlet fittings

Exploded view diagrams and parts lists can be found in the Replacement Parts section of this catalog.

Post-mix



Energy drink



Juice



Pre-mix



Wine



## WBM Bar Guns

Juice	Quick Disconnect
M44JD***	4 button juice dispenser
M46JD***	6 button juice dispenser
M48JD***	8 button juice dispenser
M410JD***	10 button juice dispenser
M412JD***	12 button juice dispenser

\*\*\*Specify accent color, type, and hose length.

Example: M410JDKS4 = 10 button juice, black, Series 2.5 (S), 4 ft. hose length

Accent Colors: K=Black, R=Red, B=Blue, G=Green, C=Cabana Blue

Dispenser type: S=Standard (2.5), 2=Series II, 3=Series III

Hose lengths: 3=3' (standard). Optional (upcharge): 4=4', 5=5', and 6=6'

If NSF listed (with plastic sheathing) is desired, add (N) to the end of the part number

Wunder-Bar WBM juice dispensers come with 3/8" tubes.

## WBM Bar Guns

Pre-Mix	Flex Hose
WBM-PMX-5	5 button dispenser
WBM-PMX-5S	5 button dispenser with ice shield
WBM-PMX-6	6 button dispenser
WBM-PMX-6S	6 button dispenser with ice shield
WBM-PMX-7	7 button dispenser
WBM-PMX-7S	7 button dispenser with ice shield

Accent colors: Black (standard), R=Red, B=Blue

Hose lengths - 36" standard. 60", 72" and 84" available optional upcharge

Wine	Flex Hose
WBM-1WD	1 button dispenser
WBM-2WD	2 button dispenser
WBM-3WD	3 button dispenser
WBM-4WD	4 button dispenser

Fast Flow	Flex Hose
WBM-1-PM-FF	1 button fast flow dispenser postmix
WBM-2-PM-FF	2 button fast flow dispenser postmix
WBM-1-PMX-FF	1 button fast flow dispenser premix
WBM-2-PMX-FF	2 button fast flow dispenser premix

Hose lengths - 36" standard. 48", 56", 60", 72" and 84" available optional upcharge

Add an "S" to the end of the part number to include an ice/cold plate shield on a pre-mix dispenser. Wine guns dispense bag-in-box wine. All fast flow dispensers are for non-carbonated products. Four barrier lines per gun is standard. Other configurations are available. Please contact your Lancer Direct representative if you don't find what you're seeking.

Exploded view diagrams and parts lists can be found in the Replacement Parts section of this catalog.

Post-mix



Energy drink



Juice



Pre-mix



Wine



## Wunder-Bar's Refurbishing Program

Effective January 1, 2014, Wunder-Bar has implemented a new program for all rebuilt/warranty Wunder-Bar dispensers.

Wunder-Bar now offers a 4-year warranty on all new bar guns and a 1-year warranty against defective parts and workmanship on remanufactured bar guns. The repair program is offered for bar guns less than 8 years old. To find the age of your bar gun check the serial number.

### Explanation of serial numbers:

Example: Serial # 01410-1052

- First two numbers (01) represent the month
- Third number (4) represents the week of the month
- Fourth and fifth numbers (10) represent the year
- Last four numbers (1052) represent the lot number

### Procedure:

Contact Lancer Direct Customer Service Department to obtain a Return Material Authorization (RMA). The following information is required to process the RMA request:

- Quantity of bar guns for repair
- Number of buttons on bar gun
- Flex hose only or Flex hose with fittings and hose hanger kit
- Type of dispenser - Postmix/Juice/Premix/Wine/Energy/Fast flow (premix or postmix type)

Repair requests will be process through Lancer Direct and the customer is responsible for all freight charges. All repairs are completed by Wunder-Bar using factory authorized parts. All available upgrades will be made to deliver the best product in the industry.

## Wunder-Bar Replacement Parts

Lancer Direct offers a complete array of replacement parts. Many are in stock. Call for availability.

Exploded view diagrams and parts lists can be found in the Replacement Parts section of this catalog.

Post-mix



Energy drink



Juice



Pre-mix



Wine



## Bar Gun Accessories

Part Number	Description
PM10-43	Hose hanger kit, complete
PH10-119	Hose hanger kit, sanitary drip cup, complete
PM10-74	Wire hose hanger kit, complete
PH10-121	Wire hose hanger kit, sanitary drip cup, complete
Q7-22	Stainless steel custom drip tray
PM10-44	Locking handle cover with lock
PMSA-15	Waitress station
PH10-36	O-ring insert tool, brass
M4PMPARTS	Mark 4 parts kit
M4FRPARTS	Mark 4 parts kit, flow reg
PM10-73	Parts kit, series III and II.5
PM10-38	Parts kit, series II
PH10-112	O-ring tool Mark 4
PH10-126	Hat plug tool Mark 4

## Bar Gun Round Snap-on Button Caps

Post-mix bar gun buttons (PH10-74- Series) have two parts; the button (PH1073), and snap-on cap. Snap-on caps come in a variety of colors, letters and abbreviations.

Part Number	Imprint	Letter Color	Cap Color
PH1073	N/A	N/A	N/A
PH10-74-001	A	White	Green
PH10-74-002	B	White	Brown
PH10-74-003	B	Black	White
PH10-74-004	C	Black	White
PH10-74-005	C	White	Red
PH10-74-006	D	Black	White
PH10-74-007	F	Black	White
PH10-74-008	G	White	Green
PH10-74-009	G	Black	Pink
PH10-74-010	G	Black	White
PH10-74-011	I	Black	White
PH10-74-012	J	Black	White
PH10-74-013	L	Black	Yellow
PH10-74-014	L	White	Green
PH10-74-015	L	Black	Pink
PH10-74-016	L	Black	White
PH10-74-017	M	Black	White
PH10-74-018	O	Black	White
PH10-74-019	O	Black	Orange
PH10-74-020	P	Black	Yellow

Exploded view diagrams and parts lists can be found in the Replacement Parts section of this catalog.



Part Number	Imprint	Letter Color	Cap Color
PH10-74-021	P	Black	White
PH10-74-022	P	White	Brown
PH10-74-023	P	White	Purple
PH10-74-024	Q	Black	White
PH10-74-025	THROTL	White	Blue
PH10-74-026	R	White	Brown
PH10-74-027	R	White	Orange
PH10-74-028	R	Black	White
PH10-74-029	R	Black	Pink
PH10-74-030	R	Black	Orange
PH10-74-031	S	Black	White
PH10-74-032	S	Black	Yellow
PH10-74-033	T	White	Brown
PH10-74-034	T	White	Red
PH10-74-035	T	Black	White
PH10-74-036	V	Black	White
PH10-74-037	W	Black	Pink
PH10-74-038	W	Black	White
PH10-74-039	X	Black	White
PH10-74-040	CR	White	Red
PH10-74-041	CR	White	Blue



## Bar Gun Round Snap-on Button Caps



Exploded view diagrams and parts lists can be found in the Replacement Parts section of this catalog.

Part Number	Imprint	Letter Color	Cap Color
PH10-74-042	DC	Black	White
PH10-74-043	DV	White	Black
PH10-74-044	GF	Black	Yellow
PH10-74-045	GF	Black	Pink
PH10-74-046	OJ	Black	Orange
PH10-74-047	RC	Black	White
PH10-74-048	RC	White	Blue
PH10-74-049	SQ	Black	White
PH10-74-050	SQ	Black	Yellow
PH10-74-051	SS	Black	White
PH10-74-052	SS	Black	Yellow
PH10-74-053	SS	White	Green
PH10-74-054	1	Black	White
PH10-74-055	2	Black	White
PH10-74-056	7UP	White	Green
PH10-74-057	EXTRACT	Black	Orange
PH10-74-058	APPLE	White	Green
PH10-74-059	BMARY	Black	White
PH10-74-060	BMARY	White	Brown
PH10-74-061	BMARY	White	Red
PH10-74-062	COLA	Black	White
PH10-74-063	COLA	White	Blue
PH10-74-064	COCO	Black	White
PH10-74-065	CHERRY	White	Red
PH10-74-066	COKE	White	Red
PH10-74-067	COLLINS	White	Black
PH10-74-068	CRAN	White	Red
PH10-74-069	DIET	White	Blue
PH10-74-070	DIET	White	Red
PH10-74-071	DIET	Blue	White
PH10-74-072	DIET	Red	White
PH10-74-073	DIET	Black	White
PH10-74-074	D PEP	White	Blue
PH10-74-075	D PEP	White	Brown
PH10-74-076	D PEP	White	Red
PH10-74-077	ONE	White	Blue
PH10-74-078	DR P	White	Brown
PH10-74-079	ADRN	Black	White
PH10-74-080	DR P	White	Red
PH10-74-081	DRY	Black	White
PH10-74-082	GALE	White	Green
PH10-74-083	GALE	Black	White
PH10-74-084	GINGER	White	Green
PH10-74-085	GINGER	Black	White

Part Number	Imprint	Letter Color	Cap Color
PH10-74-086	GRAPE	White	Purple
PH10-74-087	GATOR	Black	White
PH10-74-088	GUAVA	Black	Pink
PH10-74-089	RAVE	Black	Purple
PH10-74-090	GRPFT	Black	White
PH10-74-091	GRPFT	Black	Pink
PH10-74-092	GRPFT	Black	Yellow
PH10-74-093	GRPFT	White	Green
PH10-74-094	SUN TZU	Black	Yellow
PH10-74-095	GUAVA	Black	White
PH10-74-096	EXTRACT	Yellow	Black
PH10-74-097	ITAL	Black	White
PH10-74-098	KONDI	White	Green
PH10-74-099	LADE	Black	White
PH10-74-100	LADE	Black	Pink
PH10-74-101	LADE	Black	Yellow
PH10-74-102	LEMON	Black	White
PH10-74-103	LEMON	Black	Yellow
PH10-74-104	LEMON	Black	Pink
PH10-74-105	EXTRACT	Black	Pink
PH10-74-106	LIFT	Black	White
PH10-74-107	MANGO	Black	Orange
PH10-74-108	MAX	White	Blue
PH10-74-109	MIST	White	Green
PH10-74-110	MTDEW	Black	Yellow
PH10-74-111	MTDEW	White	Green
PH10-74-112	D 7UP	White	Green
PH10-74-113	ONE	White	Blue
PH10-74-114	ORG	Black	Orange
PH10-74-115	ORG	Black	White
PH10-74-116	(blank)	(blank)	Orange
PH10-74-117	PAPAYA	White	Purple
PH10-74-118	PASS	White	Purple
PH10-74-119	PEACH	Black	Orange
PH10-74-120	PEACH	Black	Pink
PH10-74-121	PEACH	Black	White
PH10-74-122	PIBB	White	Brown
PH10-74-123	PEPSI	White	Blue
PH10-74-124	PEPSI	White	Green
PH10-74-125	PEPSI	Black	White
PH10-74-126	PINA	Black	White
PH10-74-127	PINE	Black	Yellow
PH10-74-128	PINE	Black	White
PH10-74-129	POG	White	Purple

## Bar Gun Round Snap-on Button Caps



PH10-76 button

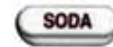

PH10-77-500, snap-on oval cap



PH10-77-501, snap-on oval cap

Part Number	Imprint	Letter Color	Cap Color
PH10-74-130	PRUNE	White	Brown
PH10-74-131	PRUNE	Black	White
PH10-74-132	PUNCH	White	Red
PH10-74-133	PUNCH	Black	Pink
PH10-74-134	PUNCH	Black	White
PH10-74-135	RASP	White	Red
PH10-74-136	RASP	Black	White
PH10-74-137	RASP	Black	Pink
PH10-74-138	RBEER	Black	White
PH10-74-139	RBEER	White	Brown
PH10-74-140	RED	White	Red
PH10-74-141	ROSE	Black	Pink
PH10-74-142	SLICE	Black	White
PH10-74-143	SLICE	Black	Orange
PH10-74-144	SLICE	White	Green
PH10-74-145	SOUR	Black	White
PH10-74-146	SOUR	Black	Yellow
PH10-74-147	SOUR	White	Green
PH10-74-148	SPRITE	White	Green
PH10-74-149	STORM	White	Green
PH10-74-150	SQUIRT	White	Green
PH10-74-151	STRAW	White	Red
PH10-74-152	STRAW	Black	Pink
PH10-74-153	STRAW	Black	White
PH10-74-154	(blank)	(blank)	Blue
PH10-74-155	SQUIRT	Black	White
PH10-74-156	SQUIRT	Black	Yellow
PH10-74-157	TEA	Black	White
PH10-74-158	TEA	White	Red
PH10-74-159	TEA	White	Brown
PH10-74-160	TOM	White	Red
PH10-74-161	TONIC	Black	White
PH10-74-162	WHITE	Black	White
PH10-74-163	SS	Black	Green
PH10-74-164	LION	Black	Yellow
PH10-74-165	BULL	White	Black
PH10-74-166	LION HEAD	Black picture	Yellow
PH10-74-167	SOBE	Black	Yellow
PH10-74-168	* (star)	Black	Yellow
PH10-74-169	TANGO	Black	Orange
PH10-74-170	ENERGY	Black	White

Part Number	Imprint	Letter Color	Cap Color
PH10-74-171	(blank)	(blank)	Brown
PH10-74-172	FUEL	White	Red
PH10-74-173	SPORT	Black	Yellow
PH10-74-174	SPORT	White	Red
PH10-74-175	SPORT	Black	Green
PH10-74-176	BONZAI	Yellow	Red
PH10-74-177	BONZAI	White	Blue
PH10-74-178	ZERO	Blue	White
PH10-74-179	TR	Black	Yellow
PH10-74-180	TSF	Black	Yellow
PH10-74-181	BL	White	Blue
PH10-74-182	POWER	White	Blue
PH10-74-183	POWER	White	Red
PH10-74-184	POWER	Black	White
PH10-74-185	RUSH	White	Red
PH10-74-186	(blank)	(blank)	Green
PH10-74-187	(blank)	(blank)	Pink
PH10-74-188	(blank)	(blank)	Purple
PH10-74-189	(blank)	(blank)	Red
PH10-74-190	(blank)	(blank)	Yellow
PH10-74-191	S	White	Green
PH10-74-192	(blank)	(blank)	White
PH10-74-193	D 7UP	Green	White
PH10-74-194	ENERGY	Black	White
PH10-74-195	(lightning bolt)	White	Black
PH10-74-196	(lightning bolt)	White	Blue
PH10-74-197	DT DEW	Green	White
PH10-74-198	DT DRP	Burgundy	White
PH10-74-199	CTHK	White	Red
PH10-74-200	LTHK	Black	Yellow
PH10-74-201	ATHK	White	Green
PH10-74-202	OTHK	Black	Orange

### Oval Button Caps

PH10-77S	SODA	Black	White
PH10-77W	WATER	Black	White
PH10-77-502	CARB	Black	White
PH10-77-503	(blank)	(blank)	White
PH10-77-504	THICK	Black	White
PH10-77-505	HONEY	Black	White
PH10-77-506	NECTAR	Black	White

## Ice Chests

One inch molded polyurethane structural insulation on all sides and bottom retains cold. All stainless steel construction with 316L or 304 stainless steel available.

- Available with or without sealed-in cold plate for post-mix
- 21" x 23" available with sealed-in cold plate;  
9 circuit post-mix
- 15" x 23" available with sealed-in cold plate;  
8 circuit post-mix
- Chests with 8 circuit cold plate have 1/2" drain

Stainless steel conversion and leg stands convert drop-in ice chests to free-standing units and are shown on page 77.



Free-standing



Drop-in

*See page 77 for  
conversion stands and leg kits*

Part Number	Type	Size W x D x H"	Capacity Lbs.	Cold Plate
95-0100	Drop-in	15 x 22 x 14.25	60	None
95-1100-7	Drop-in	15 x 22 x 14.25	60	7 circuit premix
85-0408	Drop-in	22 x 15 x 14.25	60	8 circuit postmix
95-1200-7	Drop-in	21 x 23 x 18	80	7 circuit premix
95-1200-9	Drop-in	21 x 23 x 18	80	9 circuit postmix
85-0402	Drop-in	23 x 21 x 18	100	9 circuit postmix
96-0100	Free-standing with leg set	15 x 22 x 14.25	60	None
96-1100-7	Free-standing with leg set	15 x 22 x 14.25	60	7 circuit premix
96-1100-8	Free-standing with leg set	15 x 22 x 14.25	60	8 circuit postmix
85-0461	Free-standing with legs	22 x 15 x 14.25 (+ 19.5H)	60	8 circuit postmix
96-1200-7	Free-standing with leg set	21 x 23 x	80	7 circuit premix
96-1200-9	Free-standing with leg set	21 x 23 x	80	9 circuit postmix
85-0462	Free-standing with legs	23 x 21 x 18 (+ 15.75H)	100	9 circuit postmix
30-10743	Ice chest top lid	15W x 22D	N/A	N/A
30-10742	Ice chest bottom lid	15W x 22D	N/A	N/A
30-8260	Ice chest top lid	15W x 23D	N/A	N/A
30-8259	Ice chest bottom lid	15W x 23D	N/A	N/A
30-8269	Ice chest top lid	21W x 23D	N/A	N/A
30-8268	Ice chest bottom lid	21W x 23D	N/A	N/A
Q8-30	Reverse lid set, FS2123	21W x 23D	N/A	N/A

## False Bottom Cold Plate Shields

Stainless steel false bottoms fit over the cold plate and allow ice to surround the cold plate while separating consumable ice from the ice used to chill the cold plate.

Part Number	Description	Size W x D x H"
30-9999-020602	False bottom CP shield	14W x 20D
30-9999-020603	False bottom CP shield	18.75W x 12D x 12H
30-9999-208003	False bottom CP shield	15.75W x 12D x 10H

False bottom cold plate shield



## Ice Chests

Stainless steel insulated ice bins are constructed with 18 gauge 304 stainless with drain, galvanized legs and adjustable high impact plastic feet. Lids are sold separately. Standard height is 32.5".

Mobile ice bins have 3" casters with toe activated brake, removable bottom tray and drain ball valve in the back of the unit.



Part Number	Size"	CP Circuit	Ice Bin Capacity
<b>Stainless Steel Ice Bins with Legs</b>			
BKIB-2412-18	24 X 18	None	60 lbs
BKIB-CP7-2412-18	24 X 18	7	60 lbs
BKIB-CP8-2412-18	24 X 18	8	60 lbs
BKIB-3012-18	30 X 18	None	80 lbs
BKIB-CP7-3012-18	30 X 18	7	80 lbs
BKIB-CP8-3012-18	30 X 18	8	80 lbs
BKIB-3612-18	36 X 18	None	100 lbs
BKIB-CP7-3612-18	36 X 18	7	100 lbs
BKIB-CP8-3612-18	36 X 18	8	100 lbs
BKIB-4812-18	48 X 18	None	140 lbs
BKIB-CP7-4812-18	48 X 18	7	140 lbs
BKIB-CP8-4812-18	48 X 18	8	140 lbs
BKIB-2412-21	24 X 21	None	76 lbs
BKIB-CP7-2412-21	24 X 21	7	76 lbs
BKIB-CP8-2412-21	24 X 21	8	76 lbs
BKIB-3012-21	30 X 21	None	100 lbs
BKIB-CP7-3012-21	30 X 21	7	100 lbs
BKIB-CP8-3012-21	30 X 21	8	100 lbs
BKIB-3612-21	36 X 21	None	125 lbs
BKIB-CP7-3612-21	36 X 21	7	125 lbs
BKIB-CP8-3612-21	36 X 21	8	125 lbs
BKIB-4812-21	48 X 21	None	175 lbs
BKIB-CP7-4812-21	48 X 21	7	175 lbs
BKIB-CP8-4812-21	48 X 21	8	175 lbs
<b>Stainless Steel Mobile Ice Bins</b>			
BK-MIB-2411	24 X 11	None	1.5 cu ft
BK-MIB-2422	24 X 22	None	3.0 cu ft
<b>Stainless Steel Ice Bin Lids</b>			
BKIB-L-2421	Fits BKIB-2412-21		N/A
BKIB-L-3021	Fits BKIB-3012-21		N/A
BKIB-L-3621	Fits BKIB-3612-21		N/A
BKIB-L-4821	Fits BKIB-4812-21		N/A
<b>Stainless Steel Drop-In Ice Bins</b>			
BK-DIBL-1218	12 X 18	Basin 9 X 13 X 10	
BK-DIBL-2218	22 X 18	Basin 18 X 13 X 10	
BK-DIBL-2818	28 X 18	Basin 24 X 13 X 10	
BK-DIBL-3418	34 X 18	Basin 30 X 13 X 10	
<b>Stainless Steel Drop-In Ice Bins with Water Station</b>			
BK-DIWSBL-2118G-P	21 X 18	Basin 9 X 13 X 11	
BK-DISWBL-2118X-P	21 x 18	Basin 9 X 13 X 11	
<b>Glass Filler Water Station</b>			
BK-WS-1SGF-G		Faucet and sink kit	
BK-SGF-G		Faucet only	
BK-WS		Sink only	

## Conversion Stands and Leg Stands

Stainless steel conversion and leg stands convert drop-in ice chests to free-standing units. Conversion stands include a bottom shelf for a carbonator, removable access panels, and 6" adjustable legs.

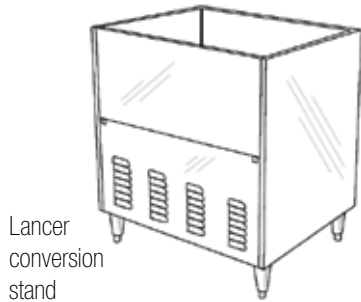

Lancer conversion stand



McCann's conversion stand



Leg stand 51-0389

Part Number	Description	Size W x D x H"
84-0006	Lancer conversion stand	17 x 25.25 x 36
84-0058	Lancer conversion stand	25 x 25 x 36
84-0059	Lancer conversion stand	31 x 25.5 x 36
16-1337	Conv. stand, knock down	17 x 25.25 x 36
16-1321	Conv. stand, knock down	25 x 25 x 36
16-1576	Conv. stand, knock down	32 x 25 x 36
16-1578	IBD stand, 22"	
16-1579	IBD stand, 30"	
LS-1522-KD	Leg stand, knock down	15 x 22 x 19.25
LS-2123-KD	Leg stand, knock down, 80 lb	21 x 23 x 19.25
51-0389	Leg stand, Lancer	15 x 22 x 19.25
51-0652	Leg stand, Lancer, 100 lb	21 x 23 x 15.75
LS-2123	Leg stand	21 x 23 x 19.25
LS-2123-100	Leg stand, 100 lb	21 x 23 x 15.25

## Cold Plates

Cold plates are placed in an ice bin. Ice chills the cold plate which chills beverages as they pass through the circuits in the cold plate before being dispensed by a bar gun. All cold plates include 5/16" MFL x 1/4" barbed fittings for each circuit, and can be special ordered with different fittings. Other sizes are available. **Designate Pre- or Post-mix when ordering.**



3016  
3018

Part Number	Description
17X19-5	5 circuit cold plate
13X20-8	8 circuit cold plate
12X18-8	8 circuit cold plate
12X18-7	7 circuit cold plate
12X18-6	6 circuit cold plate
10X15-8	8 circuit cold plate
10X15-7	7 circuit cold plate
10X15-6	6 circuit cold plate
10X15-5	5 circuit cold plate
10X15-4	4 circuit cold plate
10X15-3	3 circuit cold plate
10X15-2	2 circuit cold plate
10X15-1	1 circuit cold plate
8X14-8	8 circuit cold plate
8X14-7	7 circuit cold plate
8X14-6	6 circuit cold plate
8X14-5	5 circuit cold plate
8X14-4	4 circuit cold plate
8X14-3	3 circuit cold plate
8X14-2	2 circuit cold plate
8X12-8	8 circuit cold plate
8X12-7	7 circuit cold plate
8X12-6	6 circuit cold plate
8X12-5	5 circuit cold plate
8X12-4	4 circuit cold plate
8X12-3	3 circuit cold plate
8X12-2	2 circuit cold plate
3016	Cold plate fitting OUT to shank assy, SS, 1/2"-16 threads, 3/16" ID bore
3018	Cold plate fitting IN from coupler, SS, 3/8" OD barb

## Beer Couplers/Taps

Coupling heads can be used for single or series keg dispensing on single valve kegs. Picnic taps are for use with 4" hand pumps. Replacement parts are available.



Part #	Description
5821DBN	Type D, brass body, brass probe, lever black with pressure relief
5821SSN	Type S, brass body, brass probe, lever black with pressure relief
5841ASN	Type A, brass body, SS probe, lever black with pressure relief
5841GSN	Type G, brass body, SS probe, lever black with pressure relief
5841USN	Type U, brass body, SS probe, lever black with pressure relief
CH5000	Coupler, blue handle
CH5000SS	Coupler, stainless steel, gray handle
CH5001	Coupler, red handle
CH5003	Coupler, Sankey "D" gold handle
CH5004SS	Coupler, Sankey "D" with SS probe, blue handle
CH5100L	Lever tap with Kam-Loc barrel lock for European kegs
CH5200G	European G coupler, DSI (Bass)
CH5200G-SS	European G coupler tri-lobe DSI (Bass) with 303 SS probe, 304SS body, black handle
CH5300U	European U coupler DSI (Guinness/Harp)
CH5400A	European A coupler DSI (Warensteiner/Pauliner)
CH5400A-SS	European A coupler DSI (Warensteiner/Pauliner) with 303 SS probe, 304SS body, black handle
CK701D	U.S. Sankey coupler D style SS nickel probe
FT86	Am. Sankey fast tap with metal wing handle
FT86P	Am. Sankey fast tap with plastic wing handle
FT90	Euro single valve tap with metal wing handle
FT90P	Euro single valve tap with plastic wing handle
FT37	Picnic tap with plastic wing handle
FT37M	Picnic tap with metal wing handle
FT50	Picnic tap with metal and plastic lever handle
FT44T	Low profile tap with threaded nipple
FT44TAB	Coupler, Sankey "D", low-profile, gold wing handle
BB100990	TOF "D" coupler
BB100995	TOF "S" coupler
BB101000B-TS	TOF "G" coupler with 304SS probe
BB101001B-TS	TOF "U" coupler with 304SS probe
BB101002B-TS	TOF "A" coupler with 304SS probe
375	SS turbo tap
CUSTCOUPLER	Custom branded keg coupler
95-0231	Food grade lubricant
CP78	Growler Adaptor - USA Faucet
759	Neoprene coupling beer washer
80219	Ball retainer
24253A	Bottom seal
80220	Coupler ball
80221	Check valve coupler
80231	Coupler probe O-ring
FT40-15	Probe washer
01-2773	Adapter Fatlock 5/8"
01-2778	Adapter Fatlock 3/4"
01-2779	Growler adaptor - Highlight tap

## Picnic Pumps



Part #	Description
PP501	Pony pump, American
PP601	Bronco pump, American
PP601-4	Bronco pump with 4 faucets, American
PP602	Bronco pump, European
FT37PF	8" cylinder hand pump, wing tap, faucet/hose
4097Q	Super pump with hose and faucet, Sankey "D" probe
FT50PF	8" cylinder hand pump, handle tap, faucet/hose
BB089970	Perlick party pump with "D" system coupler
BB089973	Perlick party pump with "S" system coupler
C150	12" upright dispensing rod, no tap or knob
C151	Clamp set, holds picnic pump to upright rod
C383	Upright convertor assy, 4" metal pump, faucet, knob, all metal parts, (no coupler)
C384	Upright convertor assy, 8" metal pump, faucet, knob, all metal parts, (no coupler)
C385	D system coupler with 4" pump
C386	D system coupler with 8" pump
C393	Chrome plated brass 4" metal pump, no plastic
C393.1	4" Pump tube assembly
C393.2	Top cap
C393.22	4" Piston assembly
C393.5	Pump O-ring
C393.7	Piston spring
C393.8	Pump knob
C394	Chrome plated brass 8" metal pump, no plastic
C394.1	8" Pump tube assembly
C394.22	8" Piston assembly
C396	Connector, picnic pump to CO <sub>2</sub> inlet of coupler
C397	Vertical pump adapter, pump screws on top, coupler on bottom, air and beer line on sides
C399	Sankey pump adapter, chrome
CPSP386A	Side pump assy/coupler for import beers – A German
CPSP386D	Side pump assy/coupler for import beers – D American
CPSP386G	Side pump assy/coupler for import beers – G Bass
CPSP386S	Side pump assy/coupler for import beers – S European
CPSP386U	Side pump assy/coupler for import beers – U Guinness
UT101	Uber Tap 3 way splitter
UT102	Uber Tap foot pump
UT201D	3 way complete Uber Tap assembly – D Coupler
UT201S	3 way complete Uber Tap assembly – S Coupler
UT202D	1 Tap complete Uber Tap assembly – D coupler
UT202S	1 Tap complete Uber Tap assembly – S Coupler
UT203D	Upright complete assy with foot pump – D Coupler
UT203S	Upright complete assy with foot pump – S Coupler
C238H2	Picnic faucet with 2' hose
C238H4	Picnic faucet to beer coupler with 4' hose
1000004	CBT picnic pump faucet 5/16 barb in

## Picnic Coolers

Stainless steel coolers can be custom branded, add "BR" to the end of the part number. Lead times are shown on the next page.



CL105425



CL105435



Unbranded  
55 qt SS cooler



Branded 55 qt SS cooler

Part Number	Description
CL105420	48 qt. picnic cooler with single 50' stainless steel coil, 1 faucet, shank, coupling, NPL fittings
CL105425	48 qt. picnic cooler with single 120' stainless steel coil, 1 faucet, shank, coupling, NPL fittings
CL105430	48 qt. picnic cooler with two 50' stainless steel coils, 2 faucets, shanks, couplings, NPL fittings
CL105435	48 qt. picnic cooler with two 120' stainless steel coils, 2 faucets, shanks, couplings, NPL fittings
CL105520	48 qt picnic cooler with single faucet, 8 x 12" cold plate, shank, coupling, NPL fittings
CL105522	48 qt picnic cooler with two faucets, 8 x 12" cold plate, shanks, couplings, NPL fittings
CL105530	48 qt picnic cooler with single faucet, 10 x 15" cold plate, shank, coupling, NPL fittings
CL105540	48 qt picnic cooler with two faucets, 10 x 15" cold plate, shanks, couplings, NPL fittings
CL105542	48 qt picnic cooler with three faucets, 10 x 15" cold plate, shanks, couplings, NPL fittings
CL105545	48 qt picnic cooler with four faucets, 10 x 15" cold plate, shanks, couplings, NPL fittings
CL105450	100 qt picnic cooler with three 120' stainless steel coils, faucets, shanks, couplings
CL105550-1	54 qt SS picnic cooler with single 50' SS coil, 1 faucet, NPL fittings
CL105550-2	54 qt SS picnic cooler with two 50' SS coils, 2 faucets, NPL fittings
CL105550-3	54 qt SS picnic cooler with three 50' SS coils, 3 faucets, NPL fittings
CL105553-1	54 qt SS picnic cooler with single 120' SS coil, 1 faucet, NPL fittings
CL105553-2	54 qt SS picnic cooler with two 120' SS coils, 2 faucets, NPL fittings
CL105556-1	54 qt picnic cooler with 1 faucet, 10 x 15" cold plate, NPL fittings
CL105556-2	54 qt picnic cooler with 2 faucets, 10 x 15" cold plate, NPL fittings
CL105556-3	54 qt picnic cooler with 3 faucets, 10 x 15" cold plate, NPL fittings
CL105556-4	54 qt picnic cooler with 4 faucets, 10 x 15" cold plate, NPL fittings



## Picnic Cooler Parts and Accessories



CL202054

CL105670-2TBR

Part Number	Description
CL202054	Custom branded SS picnic cooler, 54 qt
CL105566	54 qt SS cooler 1 tap chrome column tower w one 120' SS coil
CL105566-BR	Custom branded CL105566 SS picnic cooler, single tap tower with branded fisheye on top of tower
CL105670-2TBR	Custom branded CL105570 SS picnic cooler, two tap tower with branded fisheye on top of tower
CL195100	D system tapping kit (CO2) for 1 tap picnic cooler
CL195105	D system tapping kit (CO2) for 2 tap picnic cooler
CL195150	D system tapping kit (N2) for 1 tap picnic cooler
CL195155	D system tapping kit (N2) for 2 tap picnic cooler
CL106149X	50' left stainless steel coil, 5" coil diameter
CL106150L	50' left stainless steel coil, 9" coil diameter
CL106150R	50' right stainless steel coil, 9" coil diameter
CL106212L	120' left stainless steel coil (100' x 3/8" OD + 20' x 1/4" OD), 9" coil dia.
CL106212R	120' right stainless steel coil (100' x 3/8" OD + 20' x 1/4" OD), 9" coil dia.
C301S	Special shank for Jockey Box, 3" long, 1/4" bore x 5/16" bore
C131	Wall coupling for coil cooler, 3/8" bore
C132	Wall coupling for coil cooler, 5/16" bore
C106	Grommet for stainless steel cooling, 1/4" ID
C107	Grommet for stainless steel cooling, 5/16" ID
C108	Grommet for stainless steel cooling, 3/8" ID
C207	Chrome ferrule for SS cooling, 1/4" ID
C208	Chrome ferrule for SS cooling, 5/16" ID
C216	Chrome ferrule for SS cooling, 3/8" ID
CL105200	8 qt SS coil cooler with a 50' coil and 2 cooler coupling shanks

Custom Graphics	Qty	Lead Time
Branded Coolers	1-4	7 days
	5-8	10 days
	9+	Confirmation
Fridges, Beverage Centers	1-19	7 days
	20-49	10 days
	50-99	13 days
	100+	Confirmation
Fridges, Solid Door	1-19	7 days
	20-49	10 days
	50 - 99	12 days
	100+	Confirmation



CL195105

\*Tapping kits include keg coupler(s), tubing, clamps, fittings, primary regulator with SS gauge guard, wrench



CL105200

## Mobile Ice Bins

IB-14X22 is an all stainless steel, foam-in-place insulated, portable ice bin that sits on a countertop. The interior liner opening is large enough to hold one steam pan but doesn't need to be used with a steam pan. It works well as a countertop ice display unit. Since the IB-14X22 is portable, it does not have a drain.

IBM-18X30 is an all stainless steel, foam-in-place insulated, mobile ice bin that works well as an ice bath for bottled beer or wine. A drain valve is provided for draining melted ice water.

### MIB- Features:

- Designed for iced product storage and merchandising, especially long neck bottled beer
- Foamed-in-place insulated cabinet and ABS breaker strip around liner prevents exterior condensation
- Heavy duty construction with attractive black vinyl-clad exterior that resists scratching
- Stainless steel top, liner, and perforated drain pan inserts with 1/4" radius interior corners for easy cleaning
- Built-in storage area below ice bin. Stainless steel floor has 1/4" radius corners for easy cleaning
- No plumbing required. Includes a flexible drain line with on/off valve for draining when most convenient
- Standard models have a 30" work height, liner depth 10.5"
- The -H models feature a taller cabinet base, a 36" work height, liner depth 10.5"
- The -ED models feature an extra deep bath and a 36" work height, liner depth 16.5"
- Flexible drain line with on/off valve
- 3" rubberized casters, with two locking casters
- Optional towel ring and bottle opener/cap catcher available



IB-14X22



IBM-18X30



MIB-36



MIB-36-H



BO-CC



TR towel ring



MIB-36-ED

Part Number	Description
IB-14X22	Portable countertop ice bin 22"W x 14"D x 10"H
IBM-18X30	Mobile ice bin 30"W x 18"D x 30"H, 10.5" deep liner
MIB-36	Mobile ice bath 36"W x 24"D x 30"H, 10.5" deep liner
MIB-36-ED	Mobile ice bath 36"W x 24"D x 30"H, 16.5" deep liner
MIB-36-H	Mobile ice bath 36"W x 24"D x 30"H, 10.5" deep liner
MIB-48	Mobile ice bath 48"W x 24"D x 30"H, 10.5" deep liner
MIB-48-ED	Mobile ice bath 48"W x 24"D x 30"H, 16.5" deep liner
MIB-48-H	Mobile ice bath 48"W x 24"D x 30"H, 10.5" deep liner
BO/CC	Bottle opener/cap catcher
TR	Towel ring

Mobile ice bins are made to order and not returnable.

## Special Events Dispensing

**Lancer's Multifill Beer System** is capable of pouring up to 1,800 beers in an hour, and can meet the demands of high traffic, high capacity situations in any venue. Can be manufactured for LEFT or RIGHT hand entry of beer and glycol lines. Cup size is pre-programmed during manufacture. Standard cup size is 15 oz.

- Reduces waiting queues in peak periods
- Metered dispense via electronic flow meters gives accurate dispense regardless of pressure
- Massive reduction in waste
- Available with chillerplate or icebank
- Manufactured to suit individual venues
- Available as bench mounted or mobile units
- Quick & easy installation – saves on installation costs
- Proven reliability in use in Australia and New Zealand's premier sporting, concert and event centres



82-4383

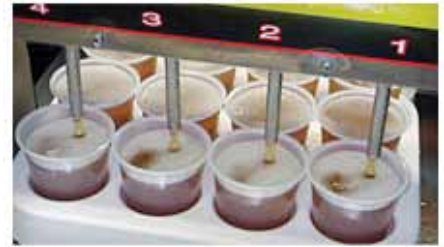

82-4383

Part Number	Description
82-4383	Multifill System microprocessor automatic dispensing system

## Lancer Breeze and BreezeR

Serve cold beer from an ambient keg, from a compact, appealing dispenser with a special tap to create creamy long-lasting foam. Dispensers have a small footprint and can be placed on any countertop, front bar or back bar. Perfect for portable bars, special events, caterers, golf clubs, microbreweries, home use and more.

Breeze ice cooled beer dispenser requires no refrigeration, no electricity and there are no moving parts. Ice capacity: 22 lbs. Ice lasts for 8 hours depending on use. Casual drink temperature is 36°F. Required: a drain for the water from melted ice, CO<sub>2</sub> bottle, CO<sub>2</sub> regulator, keg coupler and hoses. Weight: 63 lbs. 2 year warranty.

BreezeR is refrigerated. Dispensing capacity: 40L 86°F - 46.4°F (30°C - 8°C / 4H). Ice storage capacity: 17.63 lbs. (8kg). Refrigerant 134a. 115V/60Hz.



**Breeze**  
11.58" W x 15.55" H  
19.76" D without drip tray  
24.88" D with drip tray



**BreezeR**  
12.99" W x 20.07" H  
20.47" D without drip tray  
25.43" D with drip tray

Part Number	Description
85-51001	Breeze ice cooled beer dispenser
75-51001	Breeze dispenser with C-Tap faucet & handle
75-51001-D	Breeze dispenser kit, D coupler, faucet & handle
75-51001-G	Breeze dispenser kit, G coupler, faucet & handle
78-0167	BreezeR refrigerated beer dispenser & inlet kit

## Branded and Unbranded Merchandisers

All of the models below can be custom branded by adding "-BR" to the end of the part number when ordering.



RE901252



RE901252-BR



RE900071



RE900071-BR



RE901276



RE901276-BR



RE901255



RE901255-BR



RE901257



RE901257-BR



RE901275



RE901275-BR



RE901285-BR

Part Number	Description	Size W x H x D"
<b>Glass Door Countertop Models</b>		
RE901252	1 cu. ft. glass door merchandiser	13 x 23-1/2 x 15
RE901255	2 cu. ft. glass door merchandiser	16-1/2 x 29-1/4 x 17-7/8
RE901257	3 cu. ft. glass door merchandiser	19-1/8 x 36-1/2 x 21
RE900071	4.6 cu. ft. glass door merchandiser	20-1/2 x 31-3/8 x 21-1/4
RE901276	6 cu. ft. glass door merchandiser	22 x 36 x 27-13/16
<b>Glass Door Floor Models</b>		
RE901275	6 cu. ft. glass door merchandiser	23 x 40 x 23
RE901285	10 cu. ft. glass door merchandiser	23 x 54 x 23
RE901288	11 cu. ft. glass door merchandiser	23 x 62 x 23

Graphics	Qty	Lead Time
Fridges, Beverage Ccenters	1-19	7 days
	20-49	10 days
	50-99	13 days
	100+	Confirmation
Fridges, Solid Door	1-19	7 days
	20-49	10 days
	50-99	12 days
	100+	Confirmation



RE901288



RE901288-BR

## Direct Draw Keg Coolers/Dispensers

All direct draw beer dispenser feature 304 series stainless steel countertop, reinforced stainless steel floor, stainless steel reinforced threshold sill for ease of loading, removable stainless steel drip tray, incandescent interior lighting, and self-closing doors with cylinder keyed security lock.

*See page 84 for custom graphics lead times*

Part Number	Description	Size"
REX00024-SD	1 Keg direct draw cooler (no tower) SS door	24
RE801024	1 Keg dispenser with black exterior and SS top	24 x 36 x 31-1/8
RE801024SS	1 Keg dispenser with SS exterior and SS top	24 x 36 x 31-1/8
RE801050	2 Keg dispenser with black exterior and SS top	50 x 36-3/4 x 27
RE801050SS	2 Keg dispenser with SS exterior and SS top	50 x 36-3/4 x 27
RE801059	3 Keg dispenser with black exterior and SS top	59 x 36-3/4 x 27
RE801059SS	3 Keg dispenser with SS exterior and SS top	59 x 36-3/4 x 27
RE801069	3 Keg dispenser with black exterior and SS top	69 x 36-3/4 x 27
RE801069SS	3 Keg dispenser with SS exterior and SS top	69 x 36-3/4 x 27
RE801079	4 Keg dispenser with black exterior and SS top	79 x 36-3/4 x 27
RE801079SS	4 Keg dispenser with SS exterior and SS top	79 x 36-3/4 x 27
RE801090	5 Keg dispenser with black exterior and SS top	90 x 36-3/4 x 27
RE801090SS	5 Keg dispenser with SS exterior and SS top	90 x 36-3/4 x 27



REX00024-SD



RE801024



RE801024SS



RE801059



RE801059SS

## Tapping Kits for Direct Draw Dispensers

Part Number	Description
RE801012-CO2	Tapping kit for keg cooler, 1 tap CO2 kit
RE801012-N2	Tapping kit for keg cooler, 1 tap N2 kit
RE801014-CO2	Tapping kit for keg cooler, 2 tap CO2 kit
RE801014-N2	Tapping kit for keg cooler, 2 tap N2 kit



RE801090

*Cleaning kits and cleaners are shown on pages 118-122*

## Refrigerator Conversion Kits

Enjoy cold, fresh draft beer at home and save money too! A glass of draft beer is about half the cost of cans or bottles. Our Kegeerator Kits are ideal for the home bar, patio, college activities or custom installations. The kits make an excellent alternative to the more expensive Keg Refrigerator or Kegeerators.

Door Mount Conversion Kits provide straight-forward beer dispensing: beer shank and faucet is mounted over or through faucet drip tray directly into the door of a refrigerated cabinet or the wall of a cold room. For wall mounted installations, keep wall thickness to a minimum so that the shank does not warm up in the un-insulated space. Mounting the shank and beer faucet on the door of a refrigerator typically ensures adequate cooling for beer in the beer line.



*Cleaning kits and cleaners are shown on pages 118-122*

Part Number	Description
RCK-LC-S	Standard Kit: chrome faucet, faucet knob, shank, door spacer, hoses with fittings, D System for North American beers, dual gauge CO <sub>2</sub> , durable 6" x 4" stainless steel drip tray with 2" tall backsplash without drain, instructions
RCK-LC-SG	Premium Kit: chrome faucet, faucet knob, shank, door spacer, hoses with fittings, D System for North American beers, dual gauge CO <sub>2</sub> , stainless steel 6" x 6" x 11" high backsplash with 1 hole, 1 qt cleaning bottle, faucet attachment, faucet wrench, faucet brush, 4 oz line cleaner, instructions
RCK-LC-V	Value Kit: chrome faucet, faucet knob, shank, door spacer, hoses with fittings, D System for North American beers, single gauge CO <sub>2</sub> , instructions
RCK-S	Standard Kit: chrome faucet, faucet knob, shank, door spacer, hoses with fittings, D System for North American beers, dual gauge CO <sub>2</sub> , durable 6" x 4" stainless steel drip tray with 2" tall backsplash and no drain (no hassle with drain hoses and bottles), the backsplash has keyhole shaped mounting holes that allow easy removal for cleaning, 5# aluminum CO <sub>2</sub> cylinder, instructions
RCK-SG	Premium Kit: chrome faucet, faucet knob, shank, door spacer, hoses with fittings, D System for North American beers, dual gauge CO <sub>2</sub> , stainless steel 6" x 6" x 11" high backsplash with 1 hole, 1 qt cleaning bottle, faucet attachment, faucet wrench, faucet brush, 4 oz line cleaner, 5# aluminum CO <sub>2</sub> cylinder, instructions
RCK-V	Value Kit: chrome faucet, faucet knob, shank, door spacer, hoses with fittings, D System for North American beers, single gauge CO <sub>2</sub> , 5# aluminum CO <sub>2</sub> cylinder, instructions
RK-1	Basic Kit: chrome faucet, faucet knob, brass shank, door spacer, hoses with fittings, instructions
RK-1S	Basic Kit: SS faucet, faucet knob, SS shank, door spacer, hoses with fittings, instructions
RK-SU	Basic Refrigerator Conversion Kit: chrome faucet, faucet knob, shank, door spacer, hoses with fittings, D System for North American beers, instructions

## Keg and Accessories



Part Number	Description
CKN3	3 gallon keg, ball lock
C249	Keg lid O-ring
BB702600	Keg storage organizer
BB702603	Keg stack and tap 2 kegs
BB702604	Keg dolly
BB702710	20L insulated keg jacket
BB702718	58L insulated keg jacket
BB702785	Insulated keg wrap, long enough to wrap 4-58L kegs



## FOB Stop/Foam On Beer Detector

A FOB stop prevents unwanted foam when a new keg is tapped, and keeps the line primed when the keg empties. It eliminates waste, provides better beer presentation, reduces microbiological contamination, and saves time in keg changes. The FOB-Stop can be mounted directly on a keg coupler or on a wall mount bracket.



*Flooded beer manifolds are shown on page 112*

Part Number	Description
82-4353	Lancer stainless steel FOB
MP551024	Plastic FOB with 5/16 barb fittings
MP551023-C	Plastic FOB with 3/8 barb fittings
MP551027	Stainless steel FOB with 5/16 barb fittings
MP551028	Stainless steel FOB with 3/8 barb fittings
MP551050	Tecflo Classic FOB detector
MP551050-KIT	Tecflo Classic FOB detector, 2 3/8" barb fittings, 1' of drain tube, "Y" fitting to join the drain tubes
MP551055	Tecflo Deluxe FOB detector
MP551055-KIT	Tecflo Deluxe FOB detector, 2 3/8" barb fittings, 1' of drain tube, "Y" fitting to join the drain tubes
MP551058	Tecflo Deluxe FOB detector with 3/8" OD JG outlet in the bleed valve
SF087100	1/8" barb "Y" fitting for FOB drain tubing



## Beer and Wine Pumps

Whether installed on a long or short draw system, beer pumps are a cost effective means of moving beer. They also increase the pressure in the product line which prevents the gas in the beer from breaking out, thus preserving the quality of the drink.



G56-1202E



FRV0001A

FRV0001A flow reversal valve fits into a Flojet G56 beer pump allowing beer line cleaners to run cleaning solution in both directions. Running solution in alternating directions enhances cleaning efficiency.



166-257-16  
average lifespan  
35,000 gallons

Part Number	Description
G56-1202E	Flojet air/CO <sub>2</sub> driven beer pump, straight outlet, 5 gpm flow rate, ave. lifetime 70,000 gallons
G56B00HG	Flojet air/CO <sub>2</sub> driven beer pump
FRV0001A	Flow reversal valve for G56 beer pump
166-257-00	SHURflo Beer Ace II, air/CO <sub>2</sub> driven beer pump, no fittings
166-257-16	SHURflo Beer Ace II, air/CO <sub>2</sub> driven beer pump, 3/8" plastic barb liquid ports, 1/4" plastic barb elbow gas inlet w check valve
166-257-32	SHURflo Beer Ace II, air/CO <sub>2</sub> driven beer pump, 3/8" plastic barb liquid in, 3/8" John Guest adapter liquid out, 5/16" straight John Guest adapter with check valve gas inlet, 1/4" plastic barb elbow gas outlet
166-257-37	SHURflo Beer Ace II, air/CO <sub>2</sub> driven beer pump, 1/2" plastic barb elbow liquid in, 3/8" straight plastic barb liquid out, 3/8" straight plastic no check valve gas inlet
166-257-39	SHURflo Beer Ace II, air/CO <sub>2</sub> driven beer pump, 3/8" SS barb elbow liquid in, 3/8" SS barb elbow liquid out, 3/8" plastic elbow with check valve gas inlet, 1/4" plastic barb elbow gas outlet
166-257-40	SHURflo Beer Ace II, air/CO <sub>2</sub> driven beer pump, 3/8" SS barb elbow liquid in, 3/8" SS straight barb liquid out, 3/8" plastic barb elbow with check valve gas inlet
166-257-41	SHURflo Beer Ace II, air/CO <sub>2</sub> driven beer pump, 3/8" SS barb elbow liquid in, 3/8" SS barb elbow liquid out, 1/4" plastic elbow with check valve gas inlet, 1/4" plastic barb elbow gas outlet

## Flow Meters

Flow meters enable you to measure the amount of beer poured and compare it to the amount of beer your staff served in the sales report to detect waste or theft. The inline Flowmeter is to be used with a flow monitor.

Part Number	Description
MP551060	Inline flow control 5/16" OD
FM200215	Inline Flowmeter turbine 3/16" bore
FM200222	2-line flow monitor
FM200244	4-line flow monitor
FM200288	16-line flow monitor



MP551060

FM200215

FM200222



FM200288



FM200244



## Beer Pump/FOB Panels

Part Number	Description
18-0338	FOB regulator and beer pump mounting board 1 product
18-0339	FOB regulator and beer pump mounting board 2 product
18-0340	FOB regulator and beer pump mounting board 3 product
18-0341	FOB regulator and beer pump mounting board 4 product
18-0334	FOB and regulator mounting board 1 product
18-0335	FOB and regulator mounting board 2 product
18-0336	FOB and regulator mounting board 3 product
18-0337	FOB and regulator mounting board 4 product
C0869205C	12" 1P sec. reg. panel with 316SS FOB, beer pump, flow reversal valve, wall bracket, beer and gas tubing
C0869206C	23" 2P sec. reg. panel with two 316SS FOBs, 2 beer pumps, 2 flow reversal valves, wall brackets, beer and gas tubing

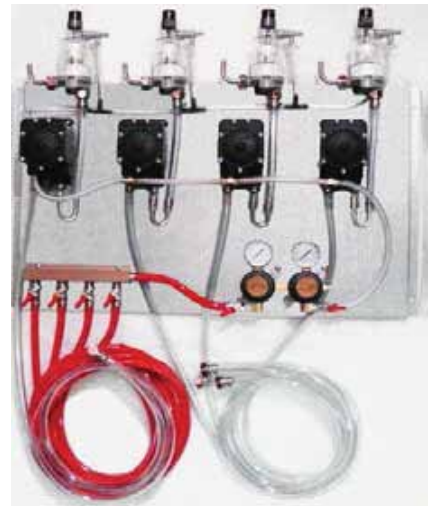

## Equipment Mounting Boards



Part #	Size"	Description
18-0348	7" x 12"	Equip. mounting board, galvanized
18-0349	7" x 18"	Equip. mounting board, galvanized
18-0350	7" x 24"	Equip. mounting board, galvanized
18-0351	12" x 12"	Equip. mounting board, galvanized
18-0352	12" x 18"	Equip. mounting board, galvanized
18-0353	12" x 24"	Equip. mounting board, galvanized
97-0212	8' x 4' x 1/2"	Manifold board, white Nycel

C0869206C



*Fllooded beer manifolds are shown on page 112*

## CO<sub>2</sub> Regulators

740 Series regulators have a polycarbonate bonnet that won't chip, break or fade. The non-adjustable "shut-down" safety can't be removed or easily circumvented. If the regulator seat fails the safety will respond instantly, isolating the product container from potentially dangerous high pressure. The product container pressure will not exceed the factory set blow-off of 55-65 PSI.

High pressure ports have left-hand female threads to prevent their use as a lo-pressure outlet... (If replacement parts are required, contact factory). The non-removable adjusting screw will never exceed 50 PSI. An internal relief valve opens whenever delivery pressure exceeds set pressure by 15 PSI. This feature serves as a warning that the seat or diaphragm may be worn or damaged and should be replaced. Seat assembly is easily replaceable in-field... no need to remove regulator from tank.

A sintered metal flow control filter in the inlet nipple prevents dirt and other particles from damaging internal parts. Permanent quad-ring seal on the inlet nipple eliminates a source of leaks, and there's no need to use a new fiber washer each time tank is changed.

The ball-type check valve helps prevent product back-up into the regulator. Hose barb end designed for use with 5/16" ID pressure tubing.

HP regulators are LH thread. LP regulators are RH thread unless otherwise specified.



Part Number	Type of Regulator	Gauge(s)	Mount	Additional Info
T741	Primary	60	Tank	Single gauge with 5/16" barb shut-off and check valve
T742	Primary	2000 x 60	Tank	Dual gauge with 5/16" barb shut-off and check valve
T742-2	Primary	2000 x 60	Tank	1 pressure x 2 products with 5/16" barb shut-off and check valve
T742HP	Primary	2000 x 60	Tank	Dual gauge, high flow, w 5/16" barb shut-off & check valve, 0-50 PSI
T752HP	Primary	2000 x 60	Tank	2 press x 2 prod, high performance 5/16" barb shut-off and check valve
T5741PMHPT	Primary	2000 x 160	Tank	Dual gauge, 5/16" barb outlet with check shutoff
FC741	Primary	12-18	Tank	Low pressure for underbar dispensing, no gauge
FC741H	Primary	30-45	Tank	Medium pressure for cold plate box dispensers, no gauge

## CO<sub>2</sub> Regulators and Regulator Panels

Part Number	Type of Regulator	Gauge	Mount	Additional Info
T1661ST	Secondary, 1P x 1P	60	Wall	Single gauge with shut-off and relief valve
T1661ST-2N	Secondary, 1P x 1P	60	Wall	Single gauge with 5/16" barb inlet/thru, 5/16" barb shutoff
1661ST-05	Secondary, 1P x 1P	60	Wall	Single gauge with 3/8" barb
T1661STC-01	Secondary, 1P x 1P	60	Wall	Single gauge with 5/16" barb inlet/thru, 5/16" barb shutoff w check
T1672ST	Secondary, 2P x 2P	60	Wall	Two gauges with shut-off and relief valve
T1672ST-2N	Secondary, 2P x 2P	60	Wall	Two gauges with 5/16" barb inlet/thru, 5/16" barb shutoff
T1672ST-2N-375	Secondary, 2P x 2P	60	Wall	Two gauges with 3/8" pass-thru
T1683ST	Secondary, 3P x 3P	60	Wall	Three gauges with 5/16" barb inlet/thru, 5/16" barb shutoff
T1683STC	Secondary, 3P x 3P	60	Wall	Three gauges with 5/16" barb inlet/thru, 5/16" barb shutoff w check
T1683ST-2N	Secondary, 3P x 3P	60	Wall	Three gauges with 5/16" barb inlet/thru, 5/16" barb shutoff
T1694ST	Secondary, 4P x 4P	60	Wall	Four gauges with shut-off and relief valve
T1694ST-2N	Secondary, 4P x 4P	60	Wall	Four gauges with 5/16" barb inlet/thru, 5/16" barb shutoff
T1672STWMK	Secondary, 2P x 2P	60	Wall	Panel, 2 gauges with shut-off and relief valve
T1683STWMK	Secondary, 3P x 3P	60	Wall	Panel, 3 gauges with shut-off and relief valve
T1694STWMK	Secondary, 4P x 4P	60	Wall	Panel, 4 gauges with shut-off and relief valve
RP-1	Secondary, 1P x 1P	60	Wall	Panel, no tubing
RP-1-60	Secondary, 1P x 1P	60	Wall	Panel, 60" jumper and CO2 tubing
RP-1-60-PFOB	Secondary, 1P x 1P	60	Wall	Panel, plastic FOB
RP-1-60-SSFOB	Secondary, 1P x 1P	60	Wall	Panel, stainless steel FOB
RP-2	Secondary, 2P x 2P	60	Wall	Panel, no tubing
RP-2-60	Secondary, 2P x 2P	60	Wall	Panel, 60" jumper and CO2 tubing
RP-2-60-PFOB	Secondary, 2P x 2P	60	Wall	Panel, plastic FOB
RP-2-60-SSFOB	Secondary, 2P x 2P	60	Wall	Panel, stainless steel FOB
RP-3	Secondary, 3P x 3P	60	Wall	Panel, no tubing
RP-3-60	Secondary, 3P x 3P	60	Wall	Panel, 60" jumper and CO2 tubing
RP-3-60-PFOB	Secondary, 3P x 3P	60	Wall	Panel, plastic FOB
RP-3-60-SSFOB	Secondary, 3P x 3P	60	Wall	Panel, stainless steel FOB
RP-4	Secondary, 4P x 4P	60	Wall	Panel, no tubing
RP-4-60	Secondary, 4P x 4P	60	Wall	Panel, 60" jumper and CO2 tubing
RP-4-60-PFOB	Secondary, 4P x 4P	60	Wall	Panel, plastic FOB
RP-4-60-SSFOB	Secondary, 4P x 4P	60	Wall	Panel, stainless steel FOB
C0875001T	Secondary, 1P		Wall	15" Taprite deluxe regulator panel, 304SS fittings, beer & gas tubing
C0875002T	Secondary, 2P		Wall	15" Taprite deluxe regulator panel, 304SS fittings, beer & gas tubing
C0875003T	Secondary, 3P		Wall	15" Taprite deluxe regulator panel, 304SS fittings, beer & gas tubing
C0875004T	Secondary, 4P		Wall	20" Taprite deluxe regulator panel, 304SS fittings, beer & gas tubing
C0869426T	Secondary, 1P		Wall	15" Taprite reg, plastic FOB panel, beer & gas tubing
C0869427T	Secondary, 2P		Wall	15" Taprite reg, plastic FOB panel, beer & gas tubing
C0869428T	Secondary, 3P		Wall	20" Taprite reg, plastic FOB panel, beer & gas tubing
C0869429T	Secondary, 4P		Wall	20" Taprite reg, plastic FOB panel, beer & gas tubing
C0869436T	Secondary, 1P		Wall	15" Taprite reg, 316SS FOB panel, beer & gas tubing
C0869437T	Secondary, 2P		Wall	15" Taprite reg, 316SS FOB panel, beer & gas tubing
C0869438T	Secondary, 3P		Wall	20" Taprite reg, 316SS FOB panel, beer & gas tubing
C0869439T	Secondary, 4P		Wall	20" Taprite reg, 316SS FOB panel, beer & gas tubing

## Nitrogen Regulators

Part Number	Type of Regulator	Gauge(s)	Mount	Additional Info
5741PMHPN	Primary Nitrogen	3000 x 160	Tank	0-120 PSI, 1/4" flare with check valve, black bonnet
5741PMHPNT	Primary Nitrogen	3000 x 160	Tank	0-120 PSI, 5/16" barb shut-off with check valve, black bonnet
742N	Primary Nitrogen	3000 x 60	Tank	0-50 PSI, 5/16" barb shut-off with ball check, black bonnet
742HPN	Primary Nitrogen	3000 x 60	Tank	0-50 PSI, 5/16" barb shut-off with duck-bill check, black bonnet
742HPN-100	Primary Nitrogen	3000 x 100	Tank	0-50 PSI, 5/16" barb shut-off with duck-bill check, black bonnet
K16630-5FP101	Primary Nitrogen	3000 x 60	Tank	0-120 PSI, economy 1/4" flare with check valve, yellow bonnet

## Gov Reg® Secondary Regulator for Taps

Takes the place of a traditional secondary regulator, based on proven medical technology for high precision and durability.

- Greatly reduces install time, effort, and expense. Set it and forget it!
- Leak test under water. Boil for sterilization
- Limited number of components to increase durability
- Impervious to corrosion
- Gas compatibility: CO<sub>2</sub>, Argon, O<sub>2</sub>, N<sub>2</sub>O, N<sub>2</sub>, gas blends
- Prevents backflow of beer from keg into gas line
- Output pressure range 4-55 psi, input pressure range 20-150 psi



Gov Reg® installed on keg coupler

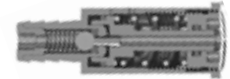

Only 12 parts compared to 25 plus of ordinary regulators

### Applications

- Short or long draw draught beer systems
- Kegs in series: events/high volume dispense
- Wine On Tap, kombucha, nitro coffee, mixed cocktails
- Soda/soft drink fountain dispense systems

Part Number	Description
G5150	Secondary regulator, dispense gove for keg couplers, pre-set to 12 psi, psi is adjustable
G5500	Dispense regulator tester/adjuster for G5200 secondary regulator for keg couplers



G5150



G5500 tester/adjuster

## DraftMore Beer Regulators

Reduce beer foaming, reduce waste and maximize earnings from each keg of beer with DraftMore beer regulators. It makes sure that the pressure in the keg is correct according to the temperature of the beer. That means the beer will foam with a regular consistency and makes it possible to get the last drops of beer out of the keg. With a DraftMore you will serve a perfect draft beer every time!



Part Number	Description
3020	DraftMore beer regulator, 2.5-2.6 carb level, auto adjusting reg for most American ales, American craft ales and most European lagers
3030	DraftMore beer regulator, 2.7-2.8 carb level, auto adjusting reg for most American brewery beers

## Regulator Parts and Accessories



**More Carbonation Testers and parts**  
are located in Water Systems on page E-9.

Part Number	Description
7000-3A	3' High pressure hose assembly
7000-6A	6' High pressure hose assembly
7000-9A	9' High pressure hose assembly
3740-2PA	Bonnet, black, 3000 series
7700-6T	Replacement diaphragm assembly, new style
7700-3C	Replacement seat assembly, new style
600GPS	Gauge boot protector
03S07100	C133 Gorman gauge protector
RK1000-0051	Gauge guard, single body regulator
440-4PN	Guide nut tool
63	Fiber CO <sub>2</sub> washer
63NY	Nylon CO <sub>2</sub> flare washer
20W1005H02L30#	Gauge, 30 # PSIG RH thread
20W1005H02L60#	Gauge, 60 # PSIG RH thread
20W1005H02L100#	Gauge, 100 # PSIG RH thread
20W1005H02L160#	Gauge, 160 # PSIG RH thread
20W1005H02L300#	Gauge, 300 # PSIG RH thread
6603-2000	Gauge, 2000 # PSIG LH thread
5603	Gauge, 3000 # PSIG RH thread
6603	Gauge, 3000 # PSIG LH thread
440-18	Wrench, CO <sub>2</sub> regulator, Taprite zinc bonnet
440-19	Wrench, CO <sub>2</sub> regulator, Taprite poly bonnet
22-0016	Wrench, CO <sub>2</sub> regulator, Lancer
08-1080-00	Regulator mounting bracket for louvered rack
5201738506212	Lock washer for regulator bracket
1690-3S	Hex bolt
43-0006-00	SS bracket for regulator mounting
REGMT-24	Regulator mount, 24", galvanized steel
PT1000	CO <sub>2</sub> pressure tester
2701-BCT	Beer carbonation tester with protective case
RBH-32	Economy Refractometer
440-12	Brass CO <sub>2</sub> inlet nipple RH thread
440-17Q	Inlet nipple quad ring
440-17R	O-ring for CO <sub>2</sub> nipple
740-12	CO <sub>2</sub> inlet nipple, O-ring seal, left hand
740-12N	Nitrogen inlet nipple 1/4" MPT left hand thread
740-13N	Nitrogen tank nut, male thread
740-16	MPT plug, 1/4" LH thread
740-19	Replacement CO <sub>2</sub> nut and nipple assy, LH
5460	Forged Y, (2) 1/4 FPT x 1/4 MPT
5232B	Brass cap, 1/4" SAE
1000730	Brass CO <sub>2</sub> nut, CGA 320
JO-11N	Regulator fitting RH thread
C296	CO <sub>2</sub> to nitrogen adapter
C295	Nitrogen to CO <sub>2</sub> adapter
15-0017-60	Regulator mounting panel 11" x 8.5" galvanized
15-0018-60	Regulator mounting panel 16" x 8.5" galvanized
15-0019-60	Regulator mounting panel 21" x 8.5" galvanized

## Regulator Parts and Accessories

Part Number	Description
6600	Shutoff outlet for BIB, no check, 1/4" SAE male
6600C	Shutoff outlet for BIB, with check, 1/4" SAE male
C0882015	Barbed shutoff, 1/4"
C0882020	Barbed shutoff, 5/16"
C0882029	Barbed shutoff, 5/16"
C0882028	Barbed shutoff with check valve, 5/16"
8100B	Brass shutoff, 1/4 MPT x 5/16 barb, w check valve
8101B	Brass shutoff, 1/4 MPT x 5/16 barb, no check valve
8120B	Brass shutoff, 1/4 MPT x 1/4 barb, w check valve
8121B	Brass shutoff, 1/4 MPT x 1/4 barb, no check valve
8160B	Brass shutoff, 1/4 MPT x 3/8 barb, w check valve
8161B	Brass shutoff, 1/4 MPT x 3/8 barb, no check valve
5153B	Inlet fitting for secondary reg., 1/4" MPT x 1/4" SAE
5436	Outlet fitting with check valve, S 1/4" AE male
5436H	Outlet fitting with check valve, 1/4" hose barb
617BN	Brass 5/16" barb x 1/4" MPT fitting
431-P44	Fitting, 1/4" MFL, 1/4" MPT, ball check w adaptor
618L	Brass nipple 1/4 RH MPT x 1/4 LH MPT
08-0564	1/4" gas hose blue self store
08-0578	1/4" gas hose yellow self store
STB78C12-12F	78 series coupler with wing-nut for bulk CO <sub>2</sub>
C02RS-C	Cornelius 160 lb CO <sub>2</sub> tank mount regulator, changeover valve, bulk system gauge with manifold check valve and shutoff



## CO<sub>2</sub> Tank Outside Storage Cabinet

Cabinet provides tank security and improved appearance. Accommodates all sizes of Chart Beverage outdoor tanks.

### Features:

- 60% open surface for cross ventilation
- 2 hinged lockable doors
- Port accommodates 2" conduit connections
- Tabs for bolting unit to concrete
- Removable roof panel protects against harsh weather
- Rustproof aluminum construction
- Powder coated gray primer is ready to paint
- Options: fill valve to fill box connection, vent kit to direct discharge to the floor

Cabinet comes un-assembled in an easy-to-ship package preventing damage in transit. Can be assembled on site in about an hour using screwdriver and small adjustable wrench. 32.6"W x 32.6"D x 76.5"H

Part Number	Description
20604733	CO <sub>2</sub> tank outside storage cabinet



Tank cabinet

## CO<sub>2</sub> Cylinders

Catalina seamless aluminum alloy compressed gas cylinders are manufactured in accordance with U.S. DOT 3AL and TC 3ALM requirements and are stamped with required U.S. Department of Transportation (DOT) and Transport Canada (TC) Markings. Every cylinder is inspected and tested by a DOT and TC authorized independent inspection agency. Service pressure: 1800 psi / 124 bar.



Part Number	Description
B5	5 lb. / 2.3 kgs. cylinder, Catalina
B10	10 lb. / 4.5 kgs. cylinder, Catalina
B20	20 lb. / 9.1 kgs. cylinder, Catalina
B35	35 lb. / 15.9 kgs. cylinder, Catalina
B50	50 lb. / 22.7 kgs. cylinder, Catalina
CGA-320	Replacement valve

## CO<sub>2</sub> Purifier

Prevents off-tastes and aromas from spoiling soda and draft beer due to CO<sub>2</sub> contaminants, such as bacteria, yeasts, molds, and particles from gas (CO<sub>2</sub>) streams, even in the presence of humidity and moisture.

Part Number	Description
BCT-2409-ATO	2" x 10" stainless steel housing and CO <sub>2</sub> filter
ATO-9SS	Replacement cartridge for BCT-2409-ATO
BCT-2510-ATO	2" x 10" nylon housing and CO <sub>2</sub> filter
ATO-10P	Replacement cartridge for BCT-2510-ATO



BCT-2409-ATO

BCT-2510-ATO



## CO<sub>2</sub> Cylinder Parts and Accessories

Part Number	Description
H1BK	Carrying handle black, Catalina
H1RD	Carrying handle red, Catalina
H2BK	Carrying handle black, Luxfer
SR1	Snap ring, Catalina
SR2	Snap ring, Luxfer
22-0016	CO <sub>2</sub> wrench
1421	High pressure changeover valve assy, 1/4" MFL
7430	High pressure changeover valve assy, 1/4" MFL
7431	CO <sub>2</sub> changeover kit
20020104	Manifold, 3/8 x 1/4 (4)
20F05-103	Gas cylinder bracket, triple, 2"H x 4"W x 37"L
20F05-102	Gas cylinder bracket, double, 2"H x 4"W x 24"L
20F05-101	Gas cylinder bracket, single, 2"H x 4"W x 8"L



Carrying handle Catalina snap ring Luxfer snap ring 22-0016



7431



7430



1421



20F05-101



20F05-102



CGA-320  
replacement valve



20F05-103

## Infinity™ Auto Changeover

The Infinity™ Auto Changeover senses a depleted cylinder and automatically switches to the reserve cylinder.

### Features

- Priority Select™ feature allows service personnel to designate which cylinder is considered primary
- Installation is quick and simple

### Benefits to Suppliers

- Eliminates emergency calls
- Requires no location involvement
- Increases customer loyalty
- Optimizes route planning

### Benefits to Customers

- Ensures a continuous supply of gas
- Eliminates the need to change cylinders
- Eliminates the need to call for service

### Ordering Instructions

- Specify CGA connections

*Note: 2-6 Cylinders may be connected in any configuration using standard pigtails. Hose assemblies are priced individually.*

Part #	Description
3563	Infinity Auto Changeover
HKCO-580-1	Hose assembly single nitrogen cylinder CGA 580
HKCO-580-2	Hose assembly dual nitrogen cylinder CGA 580
HKCO-580-3	Hose assembly triple nitrogen cylinder CGA 580
HKCO-320-1	Hose assembly single CO <sub>2</sub> cylinder CGA 320
HKCO-320-2	Hose assembly dual CO <sub>2</sub> cylinder CGA 320
HKCO-320-3	Hose assembly triple CO <sub>2</sub> cylinder CGA 320



Infinity™ Auto Changeover

Dimensions: 6"W x 4.6"H x 2"D

Gas Service: Inert

Inlet: 1/4" NPT (2)

Outlet: 1/4" NPT (1)

Safety: Self-resetting 175 psi

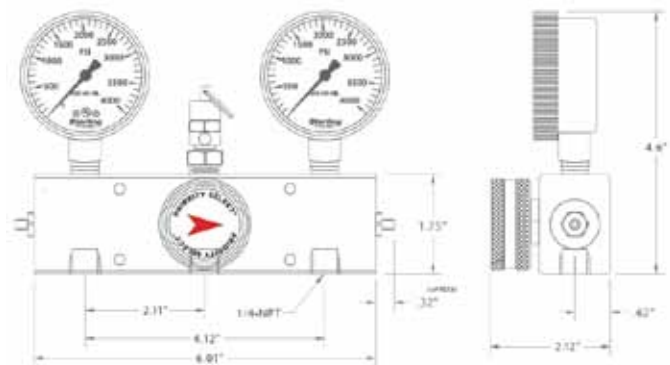



## LogiCO2 MK9/MK10 CO<sub>2</sub> Detectors/Alarms

CO<sub>2</sub> is a colorless, odorless gas which normally exists at a concentration of .04% in the air, but above 4% concentrations has dangerous effects:

- 4% = IDHL - immediate danger to health and life
- 7% = Dizziness, vomiting, headache, reduced blood supply to the brain
- 10% = Convulsions, unconsciousness, death
- 20% = Death in a few seconds

The MK9 and MK10 are the most cost effective CO<sub>2</sub> detection systems currently available. Four alarm levels fulfill ALL U.S. CO<sub>2</sub> safety codes and norms. Central unit makes non-smelling invisible CO<sub>2</sub> gas visible and advises what to do in different alarm situations. Automatic calibration is safer and zero maintenance. System is expandable up to eight sensors.

### MK10 All-In-One Sensor

The MK10 is a CO<sub>2</sub> monitor for the area CO<sub>2</sub> equipment is used or distributed. It has an integrated sound and light alarm and can be used as a stand-alone unit or can be linked to a central unit for digital display of values. The MK10 performs self-calibration at regular intervals, eliminating the need for service calibration. The sensor can be linked to an existing fire alarm system that is connected to the fire department.

### MK9 Sensor

The MK9 sensor is a precision instrument that continuously monitors temperature and CO<sub>2</sub> gas concentration using infrared analysis. It has red, yellow and green LED lights and an intermittent buzzer for Low Alarm and continuous sound for High Alarm. The MK9 performs a self-calibration at regular intervals, eliminating the need for service calibration. MK9 is compatible with MK7. The sensor can be linked to an existing fire alarm system that is connected to the fire department.

### MK9 CO<sub>2</sub> Central Unit

The multi-lingual Central Unit controls the safety system and displays measurements from up to eight MK9 or MK10 sensors. It is mounted outside the area being monitored, such as a manager's office. An information and instructional text for all Alert/Alarm and Error conditions is shown on the display. If multiple sensors are connected, each value indicates which sensor the value is from. The Central Unit has an alarm memory that remembers and reactivates any alarm after a power interruption. On the right side there is a sound mute/reset and test button.

LED and sound indications...

- Green - the system is active, normal safe conditions
- Yellow - Error
- Red - CO<sub>2</sub> concentration alarm: Low >1.5%, or High >3%
- Beeping sound indicates Low Alarm (warning) or Error
- Continuous sound indicates High Alarm (danger)

### The Need for O<sub>2</sub> Detection

Low levels of oxygen causes asphyxiation and leads to brain damage. High concentrations of nitrogen displaces oxygen. Wherever nitrogen is stored or used an O<sub>2</sub> sensor is advised. Each O<sub>2</sub> sensor comes with a horn/strobe, cables and splitters.

### Horn/Strobe and Warning Beacon

Sensors are mounted 12" from the floor and therefore may not be visible from a distance. Horn/strobe and waterproof warning beacons are mounted high above sensors to provide greater visibility and audibility. Additional horn/strobes and beacons can be added.

### Portable LogiCO2-Scout

A portable CO<sub>2</sub> sensor takes at least 30 seconds to read the correct value, yet the human body reacts in about 2 seconds. To ensure safety, the LogiCO2-Scout is rolled into potentially hazardous areas where it remotely measures the concentration of CO<sub>2</sub> and sends the values to a smartphone OUTSIDE the danger zone. Range: 65-100 feet.



CO<sub>2</sub> leaks are costly and dangerous



Fully Approved



MK10 CO<sub>2</sub> Sensor/Beacon/Horn



MK9 CO<sub>2</sub> Sensor



Central Unit



O<sub>2</sub> Sensor



Red Beacon



Horn/Strobe



LogiCO2-Scout

For more information contact [co2monitors@lancer-direct.com](mailto:co2monitors@lancer-direct.com)



**MK9 CO<sub>2</sub> Detector Set # 2049**

**Includes:**

- MK9 CO<sub>2</sub> Central Unit
- MK9 CO<sub>2</sub> Sensor
- Horn/Strobe LED with 3 ft cable
- 1 Cable red 15 ft
- 1 Cable red 30 ft
- 1 Cable blue 15 ft
- RJ45 1-1 splitter
- RJ45 1-2 splitter
- Transformer 1A & Plug - UL
- Plug-lock
- Bag with 6 screws and plug
- CO<sub>2</sub> safety monitoring sign
- Sign horn/strobe MK9/10
- Installation manual MK9
- Quick-guide MK9

**MK9 Central Unit Specifications:**

- Operating temp: 0° to 104° F
- Operating humidity: 0-95% RH
- Power supply: 24V DC
- Power usage: No alarm status: 21 mA
- Alarm status: 32 mA
- Acoustic signal-strength: 80 dBa (1m)
- Size (LxWxD): 3.5" x 6.3" x 1.5"

**MK9 Sensor Specifications:**

- Operating temp: 0° to 104° F
- Operating humidity: 0-95% RH
- Power supply: 24V DC
- Power usage: No alarm status: 56 mA,
- Alarm status: 68 mA
- Acoustic signal-strength: 76 dBa (1m)
- Automatic calibration: 60 days
- Size (LxWxD): 3.5" x 6.3" x 1.5"

**Horn/Strobe Specifications:**

- Operating temp: 23° to 122°F
- Power supply: 18-24V DC
- Power usage: 120 mA @ 24V DC supply
- Acoustic signal-strength: 110 dB / 1 m
- Flash intensity: 115 CD
- Flash frequency: 65/min
- Size (LxWxD): 5.3" x 4.5" x 2.4"

**LogiCO2 Safety Systems**



**MK10 CO<sub>2</sub> Detector Set # 2025**

**Includes:**

- MK10 CO<sub>2</sub> Detector/Alert
- Horn/strobe LED with 3 ft cable
- 1 Cable blue 30 ft
- 1 Cable red 15 ft
- Stainless steel protection bar for Sensor
- RJ45 1-1 splitter
- Transformer 1A & Plug-UL
- Plug-lock
- CO<sub>2</sub> safety monitoring sign
- Sign CO<sub>2</sub> Alert
- Sign horn/strobe MK9/10
- Installation manual MK10
- Quick-guide MK10

**Optional:**

- Part # 0328 - MK9 CO<sub>2</sub> Central Unit

**MK10 Specifications:**

- Operating temp: 0° to 122° F
- Operating humidity: 0-95% RH
- Power supply: 24V DC
- Power usage: 600 mA peak,
- 30 mA average
- Automatic calibration: 60 days
- Weight: 0.88 lbs
- Size: 3.54" diameter, height 4.75"

**Horn/Strobe Specifications:**

- Operating temp: 23° to 122°F
- Power supply: 18-24V DC
- Power usage: 120 mA @ 24V DC supply
- Acoustic signal-strength: 110 dB / 1 m
- Flash intensity: 115 CD
- Flash frequency: 65/min
- Size (LxWxD): 5.3" x 4.5" x 2.4"



CO<sub>2</sub> detection distance = 15 ft radius



**MK9 O<sub>2</sub> Detector Set # 2056**

**Includes:**

- MK9 O<sub>2</sub> Detector/Alert
- MK9 Central Unit
- Horn/Strobe LED with 3 ft cable
- Transformer 1A & Plug - UL
- 1 Cable blue 30 ft, 1 Cable red 15 ft
- RJ45 1-1 and 1-2 splitter
- O<sub>2</sub> safety monitoring & horn/strobe sign

**MK9 O<sub>2</sub> Specifications:**

- Measurement range: 0-25% O<sub>2</sub>-concentration
- Power supply: 24V DC
- Operating Principle: FB-optical
- Size (LxWxD): 3.5" x 6.3" x 1.5"



**LogiCO2-Scout # 2216**

**Includes:**

- Portable CO<sub>2</sub> sensor unit and foam ball
- Neckband with safety clip
- USB charging cable
- Note: Does not include smartphone*

**LogiCO2-Scout Specifications:**

- Works with Bluetooth communication to a iPhone or Android App
- Battery: Li-Ion 3,6V, 1150mAh
- Battery operating time: Approx. 12h
- Battery charging: with a USB - Micro USB cable to a smartphone charger
- Battery charging time: Approx. 2.5h
- Warning levels: 1.5% and 3% CO<sub>2</sub>
- Weight: 2.68 oz
- Dimension (HxWxD): 3.56" x 2.25" x .78"

## LogiCO2 MK9/MK10 CO<sub>2</sub> Detectors/Alarms

### CO<sub>2</sub> Safety System Parts and Accessories



Part #	Description
0328	Central unit add-on kit for MK7/MK9/MK10 system with 15' red cable, RJ45 1-2 splitter, CO <sub>2</sub> Safety System MK9 sign
0311	Central unit only for MK7/MK9/MK10 system
2117	MK9 CO <sub>2</sub> sensor add-on kit for MK7/MK9/MK10 system with white lens horn/strobe, cables, connectors and signs
2117A	MK9 CO <sub>2</sub> sensor add-on kit for MK7/MK9/MK10 system with amber lens horn/strobe, cables, connectors and signs
1134	MK9 CO <sub>2</sub> sensor as spare part only
2124	MK9 O <sub>2</sub> sensor add-on kit with horn/strobe, cables, splitters, connectors and power supply
2100	MK10 CO <sub>2</sub> add-on kit for MK7/MK9/MK10 system with sensor/ horn/strobe, SS protection bar, cables, connectors and signs
1158	MK10 CO <sub>2</sub> sensor with cable as spare part only
2216	LogiCO <sub>2</sub> -Scout sensor, foam ball, charging cable, neckband
0434	White lens horn/strobe, 3' cable and sign
1172	White lens horn/strobe, 3' and 33' cables, splitters and sign
0438	Amber lens horn/strobe, 3' cable and sign
1172A	Amber lens horn/strobe, 3' and 33' cables, splitters and sign
0454	White horn/strobe for outdoor use, 3' cable and sign
0427	Traffic light for MK7 and MK9, with horn and sign
0403	Flash-24-R weather proof LED warning beacon
0458	Red siren for high alarm indication, includes cable
0717	Red cable, 15 ft
0724	Red cable, 30 ft
0731	Blue cable, 15 ft
0748	Blue cable, 30 ft
0519	Cable extension 1-1
0526	Cable extension 1-2
0540	Cable extension 1-4
FWF-10511	Foldable 1" rigid raceway with adhesive backing for cables, 50 ft
0465	Remote connection to fire department or run external ventilation
0468	Shut-off valve controlled by CO <sub>2</sub> monitor during alarm or power loss
0478	Power box small, connect multi sensors with larger power supply
0474	Power box large, connect multi sensors with larger power supply
0021	Transformer power supply 1amp for MK7, MK9 and MK10
0953	USB-MODBUS interface and software to view and log CO <sub>2</sub> sensor levels on a computer
0199	MK10 stainless steel protection bar
0182	MK7 and MK9 stainless steel protection bar
1240	MK9 central unit sign
1257	MK10 CO <sub>2</sub> alert sign
1264	Horn/strobe alert sign
1278	Flash-24-R (beacon) sign
1285	Siren-24-R sign

## Aluminum Air Distributors

Part #	Description
1741S	Aluminum air distributor, 1-way with shut-off
1742S	Aluminum air distributor, 2-way with shut-off
1743S	Aluminum air distributor, 3-way with shut-off
1744S	Aluminum air distributor, 4-way with shut-off
1741	Aluminum air distributor, 1-way
1742	Aluminum air distributor, 2-way
1743	Aluminum air distributor, 3-way
1744	Aluminum air distributor, 4-way

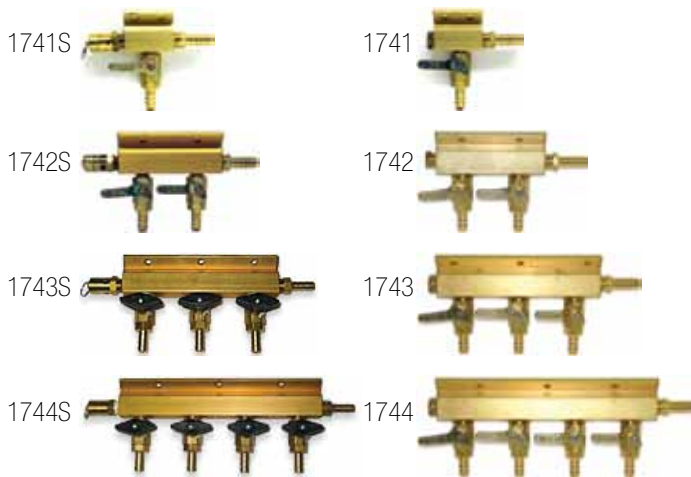

## Senco® Air Compressor

PC1010, 1 hp (peak), 1/2 hp (running) electric oil-less compressor is ultra-quiet and ultra-light (only 20 lbs.). Direct drive induction motor/pump for efficient operation. One gallon air capacity. 120 psi max output. 1/4" quick disconnect coupler. Individual gauges for tank and regulated output pressure. CSA approved. 1 year warranty.

- SCFM: 90 PSI: 0.7
- Pump Up-Time: 0-120 PSI: 128 seconds
- Recovery Time: 90-120 PSI: 35 seconds
- Max Pressure: 125 PSI
- Tank Capacity: 1 gallon
- Weight: 20 lbs.
- Dimensions: 13"H x 14"L x 10"W



Part Number	Description
0229558	Senco PC1010 oil-less air compressor, 115V

## Lancer Direct Air Compressor and Accessories

### Oil-less air compressor with air line filter/regulator:

- Motor: 5/8 HP
- Voltage: 110V/60hz
- Output: 2.6 CFM
- Maximum pressure: 100 psi
- Operating pressure: 70-100 psi
- Noise level: 62 decibels
- Tank size: 2 gallons
- Includes filter/regulator with gauge
- Dimensions: 16.5"L x 13"W x 16"H, Weight: 37 lbs.
- Shipping dimensions: 15" x 17" x 18", Shipping weight: 45 lbs.



### General Purpose Air Line Filter/Regulator

- 1/4" NPT female in/out ports 0-150 psi gauge
- 1/8" NPT female gauge port
- Maximum pressure 150 psi
- Adjustment range 0-120 psi
- Maximum flow 15 CFM
- 5 micron filter



### Automatic Condensate Drain Valve

- Timer specification: interval time 1-120 minutes, adjustable
- Supply voltage: 115V
- Valve specification: type 2/2 way direct acting
- In/out ports: 1/8" NPT female

Part Number	Description
CU012	Oil-less air compressor with filter/regulator
CU011	Oil-less air compressor with filter/regulator, auto drain valve and muffler
CU011-SC	Suitcase style compressor with auto drain and muffler
VAL039	General purpose air line filter/regulator
VAL038	Automatic condensate drain valve

Part Number	Description
82-4428	Air compressor, 6 gallon, oil free



Part Number	Description
99-2201	Air station, wall mount, 115V



## Trumix® Gas Blenders

The Trumix® blending panel is a small wall-mounted unit that is easy to install, dependable, and requires no electricity, on-going maintenance or adjustment. It can be used with all sources of clean nitrogen and CO<sub>2</sub> including high pressure cylinders, bulk tanks or separators.

TM-1 & TM-1HF are for single blend (one beer) long draw beer systems. TM-2 & TM-2HF are for systems that dispense more than one type of beer requiring two separate blends of CO<sub>2</sub> and N<sub>2</sub>. TM-3 is for triple blends.

Inlet Pressures: 55-150 psi, however, panel can be set to match any conditions (standard 55 and 70 psi). Outlet pressures are adjustable from 0-60 psi. The maximum outlet pressure will always be 10 psi lower than the lowest inlet pressure. The panel can also be ordered with outlet pressure set to custom ranges.

MV tee and straight check valve fittings protect the blender from being filled with water when the blender is being using in conjunction with a carbonator. Trumix® blender warranty only covers water damage if a MV check valve fitting was installed.



TM-1



TM-2



TM-3



Tee with check valve  
Required for McDantim warranty



MV035



MV039



BLIP  
Bypass Leak Detector

Part Number	Description
TM-1	Trumix® single gas blender 15 kegs/hour
TM-1HF	Trumix® single gas high flow blender 30 kegs/hour
TM-2	Trumix® double gas blender 30 kegs/hour
TM-2HF	Trumix® double gas high flow blender 60 kegs/hour
TM-3	Trumix® triple gas blender 30 kegs/hour
MV013	Check valve tee 1/4" x 1/4" x 1/4"
MV042	Check valve tee 3/8" x 3/8" x 3/8"
MV044	Check valve tee 1/4" x 1/4" x 3/8"
MV045	Check valve tee 1/4" x 3/8" x 3/8"
MV073	Check valve straight 1/4" x 1/4"
MV020	Beer gas analyzer with adapter
MV022	Beer gas analyzer with adapter and leak sensor
MV035	In-line leak indicator double
MV039	In-line leak indicator single
BLIP	Bypass leak detector

## Leak Detectors

The MV035 and MV039 in-line leak detectors can easily determine if there is a leak and the size of the gas leak so you will know if it requires immediate attention or is hazardous to your employees.

The Bypass Leak Detector (BLIP) can tell you in seconds if your microbrewery has leaks and how big they are. One glance before you start using gas tells you whether you have a leak or not. As you repair leaks, it serves as your scorecard, letting you know how much of the problem is resolved and if all leaks are fixed. Even the smallest leak can cost hundreds of dollars per year.

Trumix blenders come with standard 1/4" female NPT fittings, hose barbs available at no additional cost. Specify size: 1/4", 5/16", or 3/8".



MV020

MV022

Beer gas analyzers

## Oetiker Stepless Ear Clamps

Stepless ear clamps provide uniform compression and a 360° seal, ideal for securing beverage tubing to a fitting or outlet. -505R suffix means the band width is 5.0 mm and band thickness is .5 mm. -706R suffix means the band width is 7.0 mm and band thickness is .6 mm. Other sizes available, call customer service for more information.

When ordering always select the nominal size nearest to, but always larger than the outside diameter (OD) of the material to be clamped. Measurement should be determined with the connection fully assembled.



Part Number	Open Clamp	Closed Clamp	Material OD
07-0441	7.0 mm	5.8 mm	9/32"
07-0443	8.0 mm	6.8 mm	11/32"
07-0444	9.5 mm	7.8 mm	3/8"
07-0445	10.0 mm	8.3 mm	25/64"
07-0446	10.5 mm	8.8 mm	13/32"
07-0437	11.3 mm	9.6 mm	7/16"
07-0439	11.8 mm	10.1 mm	15/32"
07-0409	12.3 mm	9.8 mm	31/64"
07-0433	13.3 mm	10.8 mm	1/2"
07-0447	13.8 mm	11.3 mm	17/32"
07-0434	14.0 mm	11.5 mm	35/64"
07-0448	14.5 mm	12.0 mm	9/16"
07-0449	15.7 mm	13.2 mm	5/8"
07-0438	17.0 mm	14.5 mm	21/32"
07-0450	18.5 mm	15.3 mm	23/32"
07-0451	19.8 mm	16.6 mm	3/4"
07-0452	21.0 mm	17.8 mm	13/16"

## Crimpers/Pincers

Part Number	Description
14100387	Pincer, side jaw, compound action HIP 2800 E
C100	Standard straight jaw pincers
P-02	Side-jaw pincers



Close clamp ear(s) fully.



opening permissible after crimping use of straight jaw pincer



use of side jaw pincer held parallel to hose



use of pneumatic power tool



Remove clamp by cutting through outer edge of ear with pincers.



To remove stainless or aluminum

The following pictures are representations. Actual appearance may vary.  
Other fittings sizes and styles are available. Please call for details.

## Stainless Steel Fittings



Part #	Size"	Description
3196	1/4	Swivel nut, FFL, SS
3178	3/8	Swivel nut, FFL, SS
1000222	1/4	Swivel nut, FFL, nickel plate brass
1000227	5/16	Swivel nut, FFL, nickel plate brass
1000232	3/8	Swivel nut, FFL, nickel plate brass
1002118	1/2	Swivel nut, FFL, nickel plate brass



1000215	1/8	Barb stem for 1/4" swivel nut
1000221	1/4	Barb stem for 1/4" swivel nut
1000229	1/8	Barb stem for 5/16" swivel nut
1000226	1/4	Barb stem for 5/16" swivel nut
1000231	1/4	Barb stem for 3/8" swivel nut
1000234	3/8	Barb stem for 3/8" swivel nut
1002121	1/2	Barb stem for 1/2" swivel nut



050011	1/4	Flare washer, plastic, white
050012	5/16	Flare washer, plastic, red
050017	3/8	Flare washer, plastic, black
050018	1/2	Flare washer, plastic, white



1000204	1/4	Cap nut, flare
1000212	3/8	Cap nut, flare



7107	(2) 1/8	Splicer, barb, SS
3022	(2) 3/16	Splicer, barb, SS
1000590	(2) 1/4	Splicer, barb, SS
10000592	(2) 3/8	Splicer, barb, SS
1000481	(2) 1/2	Splicer, barb, SS



7217	(2) 1/4	Tube x barb, SS
7212	3/8 x 1/4	Tube x barb, SS
7216	(2) 3/8	Tube x barb, SS
7259	(2) 1/2	Tube x barb, SS



Part #	Size"	Description
3224	5/16 x 3/8	Splicer, reducing, SS
3292	3/8 x 7/16	Splicer, reducing, SS
1001723	3/8 x 1/2	Splicer, reducing, SS
7117	1/8 x 1/4	Splicer, reducing, SS
7118	1/8 x 3/8	Splicer, reducing, SS
1000594	1/4 x 3/8	Splicer, reducing, SS
3223	1/4 x 5/16	Splicer, reducing, SS
3137	1/4 x 1/2	Splicer, reducing, SS



7107	1/8	Plug, barb, SS
C194	3/16	Plug, barb, SS
1002119	1/4	Plug, barb, SS
3220	5/16	Plug, barb, SS
1002120	3/8	Plug, barb
1002150	1/2	Plug, barb



1000423	(2) 1/4	Elbow, barb, SS
1000431	(2) 3/8	Elbow, barb, SS
1002114	(2) 1/2	Elbow, barb, SS



1000429	1/4 x 3/8	Elbow, barb, reducing, SS
7132	1/4 x 1/2	Elbow, barb, reducing, SS
S29-68	3/8 x 1/2	Elbow, barb, reducing, SS



7014	(2) 1/4	Elbow, forged, 2 barbs
7156	(2) 3/8	Elbow, forged, 2 barbs
7249	(2) 1/2	Elbow, forged, 2 barbs



1002115	(3) 1/4	Y tee, barb, 90° branch, SS
7075	(2) 1/4x3/8	Y tee, barb, 90° branch, SS
1002348	(2) 1/4x3/8	Y tee, barb, 90° branch, SS
1002350	(2) 3/8x1/4	Y tee, barb, 90° branch, SS
1002117	(3) 3/8	Y tee, barb, 90° branch, SS
1002129	(3) 1/2	Y tee, barb, 90° branch, SS



The following pictures are representations. Actual appearance may vary.  
Other fittings sizes and styles are available. Please call for details.

## Stainless Steel Fittings



Part #	Size"	Description
7115	(3) 1/8	Tee, barb, SS
1001280	(3) 1/4	Tee, barb, SS
1000526	(2) 1/4x3/8	Tee, barb, SS
7065	(2) 1/4x1/2	Tee, barb, SS
1000525	(3) 3/8	Tee, barb, SS
1000527	(2) 3/8x1/4	Tee, barb, SS
1002177	(2) 3/8x1/2	Tee, barb, SS
1001728	(2) 3/8x1/2	Tee, barb, SS
1002122	(3) 1/2	Tee, barb, SS
7097	(2) 1/2x1/4	Tee, barb, SS
1001724	(2) 1/2x3/8	Tee, barb, SS



7102	(4) 1/8	Cross, barb, SS
1000564	(4) 1/4	Cross, barb, SS
1000565	(4) 3/8	Cross, barb, SS
7081	(4) 1/2	Cross, barb, SS
7019	(3) 1/4x3/8	Cross, barb, SS
7180	(3) 1/4x1/2	Cross, barb, SS
7111	(3) 3/8x1/4	Cross, barb, SS



7106	(4) 1/4	Cross, barb, water fork, SS
7137	(3) 1/4x3/8	Cross, barb, water fork, SS
7144	(4) 3/8	Cross, barb, water fork, SS



1002123	(2) 1/4	U-bend, barb, SS
4047	(2) 5/16	U-bend, barb, SS
9019	(2) 3/8	U-bend, barb, SS
1002124	(2) 3/8	U-bend, barb, small radius, SS
4009	(2) 3/8	U-bend, barb, large radius, SS
1002125	(2) 1/2	U-bend, barb, SS
4050	(2) 3/4	U-bend, barb, SS



1002126	(3) 1/4	U-bend, barb, SS
1002128	(3) 3/8	U-bend, barb, SS
7066	(3) 1/2	U-bend, barb, SS



Part #	Size"	Description
7157	(2) 1/4x1/8	U-bend, barb manifold 1/8 port, SS
7126	(2) 1/4x3/8	U-bend, barb manifold 3/8 port, SS
1007126	(2) 1/4x3/8	U-bend, barb manifold 3/8 port, SS
7094	(2) 1/4x3/8	U-bend, barb manifold 3/8 port small radius, SS
1002127	(2) 3/8x1/4	U-bend, barb manifold 1/4 barb port, SS
7143	(2) 3/8x1/2	U-bend, barb manifold 1/2 port, SS
7067	(2) 1/2x3/8	U-bend, barb manifold 3/8 port, SS
7159	(2) 1/2x1/4	U-bend, barb manifold 1/4 barb port, SS



1002315	(2) 3/8 x (3) 3/8	U-bend, barb manifold 3/8 barb ports, SS
7139	(2) 1/2 x (2) 1/4	U-bend, barb manifold 1/4 barb ports, SS
7140	(2) 1/2 x (3) 1/4	U-bend, barb manifold 1/4 barb ports, SS
7154	(2) 1/2 x (5) 1/4	U-bend, barb manifold 1/4 barb ports, SS
7376	(2) 1/2 x (2) 3/8	U-bend, barb manifold 3/8 barb ports, SS



7155	(2) 1/4x1/4	U-bend, barb x 1/4 MFL port, SS
1000135	(2) 3/8x1/4	U-bend, barb x 1/4 MFL port, SS
7076	(2) 1/2x1/4	U-bend, barb x 1/4 MFL port, SS
1002358	(2) 1/2x1/4	U-bend, barb x 1/4 MFL port, SS



7086	(2) 3/8 x (3) 1/4	U-bend, barb x 1/4 MFL port, SS
7104	(2) 3/8 x (4) 1/4	U-bend, barb x 1/4 MFL port, SS
7087	(2) 3/8 x (5) 1/4	U-bend, barb x 1/4 MFL port, SS
7077	(2) 1/2 x (3) 1/4	U-bend, barb x 1/4 MFL port, SS
7078	(2) 1/2 x (5) 1/4	U-bend, barb x 1/4 MFL port, SS



7260	(2) 3/8x1/4	U-bend, barb x 1/4 MPT port, SS
MF38NSXL	3/8	MFL 3/8 nut & stem set, extra long stem
S21-44	1/4	Shallow nut 1/4 stem
S21-54	5/16	Stem 5/16 MFL for 1/4 nut

The following pictures are representations. Actual appearance may vary.  
Other fittings sizes and styles are available. Please call for details.

## Stainless Steel Fittings



Part #	Size"	Description
1000017	1/4	Plug, MFL, SS
3032	5/16	Plug, MFL, SS



S86-44	(2) 1/4	Adapter, MFL x FPT
S91A-46	1/4 x 3/8	Adapter, MFL x FFL
S86-66	(2) 3/8	Adapter MFL x FPT



1000347	(2) 1/4	Union, MFL x MFL
1000348	1/4 x 5/16	Union, MFL x MFL
3003	(2) 5/16	Union, MFL x MFL
3005	3/8 x 1/4	Union, MFL x MFL
1000356	(2) 3/8	Union, MFL x MFL



S88-42	1/4 x 1/8	Adapter, MFL x MPT
1000338	(2) 1/4	Adapter, MFL x MPT
S88-44	(2) 1/4	Adapter, MFL x MPT
S88-46	1/4 x 3/8	Adapter, MFL x MPT
1000335	1/4 x 3/8	Adapter, MFL x MPT
S88-64	3/8 x 1/4	Adapter, MFL x MPT
1000334	(2) 3/8	Adapter, MFL x MPT
S88-68	3/8 x 1/2	Adapter, MFL x MPT



1000244	(2) 1/4	Adapter, barb x 1/4 MFL, SS
3016	1/4 x 5/16	Adapter, barb x 5/16 MFL, SS
1000251	1/4 x 3/8	Adapter, barb x 3/8 MFL, SS
1000245	3/8 x 1/4	Adapter, barb x 1/4 MFL, SS
3018	3/8 x 5/16	Adapter, barb x 5/16 MFL, SS
1000252	(2) 3/8	Adapter, barb x 3/8 MFL, SS
7244	1/2 x 1/4	Adapter, barb x 1/4 MFL, SS



7055	(3) 1/4	Flare tee, 2 MFL x swivel nut, SS
------	---------	-----------------------------------



Part #	Size"	Description
1000520	(3) 1/4	Flare tee, full MFL, SS
1002359	(3) 5/16	Flare tee, full MFL, SS
7021	(3) 5/16	Flare tee, full MFL, SS
1000529	(3) 3/8	Flare tee, full MFL, SS



1000522	(3) 1/4	Flare tee, 2 barb x MFL, SS
7025	(2) 1/4x3/8	Flare tee, 2 barb x MFL, SS
7024	(3) 3/8	Flare tee, 2 barb x MFL, SS
7026	(2) 3/8x1/4	Flare tee, 2 barb x MFL, SS



7029	(4) 1/4	Cross, 3 barb x MFL, SS
7031	(3) 1/4x3/8	Cross, 3 barb x MFL, SS
7030	(3) 3/8x1/4	Cross, 3 barb x MFL, SS
7032	(4) 3/8	Cross, 3 barb x MFL, SS



7027	(4) 1/4	Cross, full MFL, SS
7028	(4) 3/8	Cross, full MFL, SS



7098	(2) 1/4	Union, elbow, FFL x MFL
7373	(2) 3/8	Union, elbow, FFL x MFL



7070	(3) 1/4	FFL swivel x 2 MFL
7276	(3) 3/8	FFL swivel x 2 MFL



7056	(2) 1/4	Union, FFL x FFL
7295	(2) 3/8	Union, FFL x FFL
S89-66	(2) 3/8	Union, FFL x FFL

The following pictures are representations. Actual appearance may vary.  
Other fittings sizes and styles are available. Please call for details.

## Stainless Steel Fittings



Part #	Size"	Description
1002112	3/8 x 1/4	Adapter, barb x FFL



1001376	3/8 x 1/4	Adapter, barb x swivel nut
7114	1/2 x 3/8	Adapter, barb x swivel nut
7232	1/2 x 1/2	Adapter, barb x swivel nut



1000424	(2) 1/4	Elbow, swivel nut x barb, SS
1002113	1/4 x 3/8	Elbow, swivel nut x barb, SS
1002313	3/8 x 1/4	Elbow, swivel nut x barb, SS
1007059	3/8 x 1/4	Elbow, swivel nut x barb, SS
7153	5/16 x 1/4	Elbow, swivel nut x barb, SS
1002139	(2) 3/8	Elbow, swivel nut x barb, SS
1000434	(2) 3/8	Elbow, swivel nut x barb, SS
1003086	3/8 x 1/2	Elbow, swivel nut x barb, SS
7191	(2) 1/2	Elbow, swivel nut x barb, SS



7015	1/4x1/4	U-bend, 180°, swivel nut x barb, SS
------	---------	-------------------------------------



7219	1/4 x 1/8	Adapter, elbow, barb x MPT
7190	1/4 x 3/8	Adapter, elbow, barb x MPT
7184	(2) 1/4	Adapter, elbow, barb x MPT
7223	3/8 x 1/8	Adapter, elbow, barb x MPT
7162	3/8 x 1/4	Adapter, elbow, barb x MPT
7166	(2) 3/8	Adapter, elbow, barb x MPT
7175	3/8 x 1/2	Adapter, elbow, barb x MPT
7188	3/8 x 3/4	Adapter, elbow, barb x MPT
S318P8	(2) 1/2	Adapter, elbow, barb x MPT
7215	1/2 x 3/4	Adapter, elbow, barb x MPT



1000518	(3) 1/4	Flare tee, 2 barb x swivel nut, SS
7082	(2) 3/8x1/4	Flare tee, 2 barb x swivel nut, SS
7044	(2) 1/4x1/4	Flare tee, 2 barb x swivel nut SS
7045	(3) 3/8	Flare tee, 2 barb x swivel nut, SS



Part #	Size"	Description
S27-22	(2) 1/8	Adapter, barb x 1/8 MPT, SS
3273	1/4 x 1/8	Adapter, barb x 1/8 MPT, SS
S27-44	(2) 1/4	Adapter, barb x 1/4 MPT, SS
S27-46	1/4 x 3/8	Adapter, barb x 3/8 MPT, SS
3278	3/8 x 1/8	Adapter, barb x 1/8 MPT, SS
3243	3/8 x 1/4	Adapter, barb x 1/4 MPT, SS
S27-66	(2) 3/8	Adapter, barb x 3/8 MPT, SS
S27-68	3/8 x 1/2	Adapter, barb x 1/2 MPT, SS
7262	3/8 x 3/4	Adapter, barb x 3/4 MPT, SS
S27-86	3/8 x 1/2	Adapter, barb x 1/2 MPT, SS
S27-88	(2) 1/2	Adapter, barb x 1/2 MPT, SS
7170	1/2 x 3/4	Adapter, barb x 3/4 MPT, SS
S27-1212	3/4 x 3/4	Adapter, barb x 3/4 MPT, SS



7182	(3) 1/4	Tee, 2 barb x MPT, SS
C134	(3) 3/16	Tee, 2 barb x MPT, SS
7185	(2) 3/8x1/4	Tee, 2 barb x MPT, SS
7181	(2) 1/4x3/8	Tee, 2 barb x MPT, SS
7171	(3) 3/8	Tee, 2 barb x MPT, SS
7189	(2) 3/8x1/2	Tee, 2 barb x MPT, SS
7168	(3) 1/2	Tee, 2 barb x MPT, SS
7169	(2) 1/2x3/4	Tee, 2 barb x MPT, SS
1007169	(2) 1/2x3/4	Tee, 2 barb x MPT, SS



4016		Knurled cap nut, 10/24 thread
------	--	-------------------------------



3160		Knurled shoulder screw
------	--	------------------------



7263	(2) 1/4	Adapter, compression x barb
7280	3/8 x 1/4	Adapter, compression x barb
7264	3/8 x 3/8	Adapter, compression x barb



1002136	3/8 x 3/8	Adapter, compression x compression, SS
---------	-----------	--

The following pictures are representations. Actual appearance may vary.  
Other fittings sizes and styles are available. Please call for details.

## Stainless Steel Fittings



Part #	Size"	Description
7037	(2) 1/4	Adapter, compression x barb
1007037	(2) 1/4	Adapter, compression x barb
7039	5/16 x 1/4	Adapter, compression x barb
7038	1/4 x 3/8	Adapter, compression x barb
1007038	1/4 x 3/8	Adapter, compression x barb
1007039	5/16 x 1/4	Adapter, compression x barb
7040	5/16 x 3/8	Adapter, compression x barb
1007040	5/16 x 3/8	Adapter, compression x barb
7041	3/8 x 1/4	Adapter, compression x barb
1007041	3/8 x 1/4	Adapter, compression x barb
1002137	3/8 x 1/4	Adapter, compression x barb, no O-ring
7042	(2) 3/8	Adapter, compression x barb
1007042	(2) 3/8	Adapter, compression x barb



7069	1/4 x 1/4	Adapter, compression x MFL
7088	5/16 x 1/4	Adapter, compression x MFL
7043	1/4 x 5/16	Adapter, compression x MFL
7060	5/16 x 3/8	Adapter, compression x MFL
7061	3/8 x 3/8	Adapter, compression x MFL
3068	3/8	Compression spacer



3048		Valve plug, General Beverage
3049		Valve plug, Dole



7124	3/8	Outlet straight, GB
1002310	3/8 x 1/4	Dole 3/8 inlet x 1/4 barb



7128	1/4	Outlet 90° elbow, double O-rings, Dole/GB
7072	3/8	Outlet 90° elbow, double O-rings, Dole/GB
7064	1/2	Outlet 90° elbow, double O-rings, Dole/GB



1002306	1/4	Port, 90° elbow, Shurflo
1002309	3/8	Port, 90° elbow, Shurflo
94-178-51	1/2	Port, 90° elbow, Shurflo



Part #	Size"	Description
7245	1/4	Port, straight, Shurflo
94-178-19	3/8	Port, straight, Shurflo
94-178-27	1/2	Port, straight, Shurflo



1002307	1/4	Outlet straight, Flojet
1002308	3/8	Outlet straight, Flojet
20606-100	1/2	Outlet straight, Flojet



20607-100	1/4	Outlet 90° elbow, Flojet
20608-100	3/8	Outlet 90° elbow, Flojet
3143180	3/8	Outlet 180° U-bend, Flojet
7120	1/2	Outlet 90° elbow, Flojet
7049	1/4	Outlet 90° double ring, Flojet
7048	3/8	Outlet 90° double ring, Flojet
7064	1/2	Outlet 90° double ring, Flojet



PM10-9	1/4	Inlet, straight, Wunder-Bar
PM10-10	5/16	Inlet, straight, Wunder-Bar
PM10-11	3/8	Inlet, straight, Wunder-Bar



PM10-47	1/4	Inlet, straight long, Wunder-Bar
PM10-12	3/8	Inlet, straight long, Wunder-Bar
PM10-57	1/2	Inlet, straight long, Wunder-Bar



PM10-61	1/4	Inlet, 45°, Wunder-Bar
PM10-59	3/8	Inlet, 45°, Wunder-Bar
PM10-79	1/2	Inlet, 45°, Wunder-Bar



PM10-13	1/4	Inlet, 90°, Wunder-Bar
PM10-53	3/8	Inlet, 90°, Wunder-Bar
PM10-78	3/8	Inlet, long 90° Wunder-Bar
PM10-58	1/2	Inlet, 90°, Wunder-Bar

## Stainless Steel Fittings



Part #	Size"	Description
S6510-6-1/8	6mm	6mm x G1/8 straight



6550-6	6mm	6mm union elbow
6550-8	8mm	8mm union elbow



S6520-6-1/8	6mm	6mm x G1/8 elbow
-------------	-----	------------------



S6430-6-1/8	6mm	6mm x G1/8 branch tee
-------------	-----	-----------------------



## Stainless Steel Fittings Kits

8012	Fittings starter kit
8025	Fittings starter kit, economy

## Stainless Steel Valves



V13-S	Needle valve 1/4 MFL x 1/4 MFL
-------	--------------------------------



V17-S	Needle valve 1/4 MFL x 1/4 swivel nut
-------	---------------------------------------



V6S-66	Needle valve 3/8 MFL x 3/8 MFL
--------	--------------------------------

## Stainless Steel Manifolds



Part #	Description
7017	Manifold 8.5" long (9) 1/4 MFL
7016	Manifold 8.5" long (7) 1/4 MFL
7050	Manifold 8.5" long (7) 1/4 MFL and (2) 3/8 MFL ends



7151	Manifold 8" long (5) 3/16 barb and (2) 1/4 MFL ends
7152	Manifold 8" long (4) 3/16 barb and (2) 1/4 MFL ends



7218-1	Manifold 3.5" long (2) 5/32 barbs (2) 3/8 barbs ends
7218-3	Manifold 4.5" long (3) 5/32 barbs (2) 3/8 barbs ends
7218-5	Manifold 5.5" long (4) 5/32 barbs (2) 3/8 barbs ends



2002891	Manifold 3/8 UNF w 2 port x 3/8 UNF
2002892	Manifold 3/8 UNF w 2 port x 5/8 UNF
2002893	Manifold 3/8 UNF w 2 port x 7/16 UNF



2002894	Manifold 3/8 UNF w 3 port x 3/8 UNF
2002895	Manifold 3/8 UNF w 3 port x 5/8 UNF
2002896	Manifold 3/8 UNF w 3 port x 7/16 UNF



2002897	Manifold 3/8 UNF w 6 port x 3/8 UNF
2002898	Manifold 3/8 UNF w 6 port x 5/8 UNF
2002899	Manifold 3/8 UNF w 6 port x 7/16 UNF



2003125	Manifold 3/8 5 port w valve
2003126	Manifold 3/8 6 port w valve
2003127	Manifold 1/2 5 port w valve
2003128	Manifold 1/2 6 port w valve

The following pictures are representations. Actual appearance may vary.  
Other fittings sizes and styles are available. Please call for details.

## Beer Fittings



Part #	Size"	Description
526A	3/16	Hose stem/nipple
526B	1/4	Hose stem/nipple
526E	5/16	Hose stem/nipple
526C	3/8	Hose stem/nipple
1014	7/16	Hose stem/nipple
526D	1/2	Hose stem/nipple



1020	7/8	Beer swivel nut, nickel
80228		Beer hex nut



525	1/2	Beer wing nut
-----	-----	---------------



610B		Locking nut
------	--	-------------



C116		Beer washer
------	--	-------------



1001975	1/4	Bulkhead fitting MFL
---------	-----	----------------------



C115	1/4	Tail piece with 1/4" MFL (easily change from commercial to homebrew keg)
------	-----	--



7269	1/4	Hose stem 1/4" MFL SS tail piece
------	-----	----------------------------------



C118	19/32 x 1/4 FFL	Corny plug adapter, male end 19/32"-18 threads, other end 1/4" FFL
------	-----------------	--



457C	1/4	Cabinet fitting 1/4 MFL with nut
------	-----	----------------------------------



Part #	Size"	Description
7167	3/16	Hose stem/nipple elbow, SS
7176	1/4	Hose stem/nipple elbow
7308	1/4	Hose stem/nipple elbow, SS
7250	3/8	Hose stem/nipple elbow



4008	1/4	Barb x smooth elbow, SS
4031	3/16	Barb x smooth elbow, SS
4041	3/8	Barb x smooth elbow, SS
4090	1/2	Barb x smooth elbow, SS



9400		Beer lever
------	--	------------



C601		Chrome keg coupler elbow
FT872		Elbow fitting for FT86 and FT86P taps, nickel



01-2953		Beer shank coupling nut chrome
---------	--	--------------------------------



C308		Shank grommet, 100 pack
------	--	-------------------------

The following pictures are representations. Actual appearance may vary.  
Other fittings sizes and styles are available. Please call for details.

## Beer Fittings



Part #	Size"	Description
BWB-66	3/8	Wall bracket barb elbow, SS



BWB-66S	3/8	Wall bracket barb straight, SS
---------	-----	--------------------------------



BWB-67-45L	3/8	Wall bracket barb x male beer thread, SS
------------	-----	--



BWB-77-45L	3/8	Wall bracket male beer thread x male beer thread SS
------------	-----	---



BWB-66U	3/8	Wall bracket barb U-bend, SS
---------	-----	------------------------------



BWB-77U	7/8	Wall bracket male beer thread U-bend, SS
---------	-----	--



132	3/8	Beer wye MBT x MBT x FBT swivel
CP137SS	3/8	Beer SS "Y" fitting, 3/8" ID bore, 5/8" BSP thread, 2.5" H



CP271	7/8	2-way wall bracket, forged, MBT
-------	-----	---------------------------------



133	7/8	3-way wall bracket, forged, MBT
-----	-----	---------------------------------



Part #	Size"	Description
C270	3/8	Beer shut-off, SS



131	7/8	3-way wall bracket, MBT with shut-offs
-----	-----	--



272	7/8	Beer shut-off, MPT x FPT
-----	-----	--------------------------



760	7/8	Wall bracket MBT x FBT with shut-off
-----	-----	--------------------------------------



C76MBT		Beer shut-off valve 304SS
--------	--	---------------------------



03-0481	5/16	Beer line saddle, 1 way
03-0487	3/8	Beer line saddle, 1 way
03-0488	3/8	Beer line saddle, 2 way
03-0489	3/8	Beer line saddle, 3 way
03-0490	3/8	Beer line saddle, 4 way
03-0493	1/2	Beer line saddle, 1 way
03-0494	1/2	Beer line saddle, 2 way
03-0495	1/2	Beer line saddle, 3 way
03-0496	1/2	Beer line saddle, 4 way
03-0499	5/8	Beer line saddle, 1 way
03-0500	5/8	Beer line saddle, 2 way
03-0501	5/8	Beer line saddle, 3 way
03-0502	5/8	Beer line saddle, 4 way



70030L-DB312		Shut-off valve assembly
--------------	--	-------------------------

01-2780	(2) 1/4	Brass tail BSP x barb
---------	---------	-----------------------

The following pictures are representations. Actual appearance may vary.  
Other fittings sizes and styles are available. Please call for details.

## Beer Fittings



Part #	Size"	Description
01-2763		Gas valve 1/4" Fatlock



48-3070		Beer manifold, 2 way Fatlock, 304SS complete
48-3071		Beer manifold, 3 way Fatlock, 304SS complete
48-3072		Beer manifold, 4 way Fatlock, 304SS complete



BB101663

BB101662		Stainless beer manifold w PRV, 2 MBT outlets with 3/8" bore
BB101663		Stainless beer manifold w PRV, 3 MBT outlets with 3/8" bore
BB101664		Stainless beer manifold w PRV, 4 MBT outlets with 3/8" bore



01-2773		Fatlock adapter, 5/8"
02-0134		5/8" Fatlock adaptor O-ring
02-0654		Fatlock 5/8" adapter service kit



01-2778		Fatlock adapter, 3/4"
02-0662		3/4" Fatlock adaptor O-ring
02-0653		Fatlock 3/4" adapter service kit



01-2774		Beer line check valve, SS, Fatlock 1/4" x 3/8"
01-2775		Beer line check valve, SS, Fatlock 3/8" x 5/8"
01-2777		Beer line check valve, SS, Fatlock 3/8" x 1/2"



01-2779		Fatlock flushout/flowback snap on adapter
02-0219		Fatlock flushout adaptor O-ring

Part #	Size"	Description
01-2848		FOB manifold adaptor Fatlock
01-2772		FOB barb 3/8" tail

02-0099		Fatlock valve O-ring
02-0655		Fatlock beer valve service kit



01-2932		1/4 MPT x 1/4 barb shutoff
01-2933		1/4 MPT x 5/16 barb shutoff
01-2934		1/4 MPT x 3/8 barb shutoff



66000004		Tap adaptor Fatlock shank
----------	--	---------------------------

88776292		Flowback block nylon
----------	--	----------------------

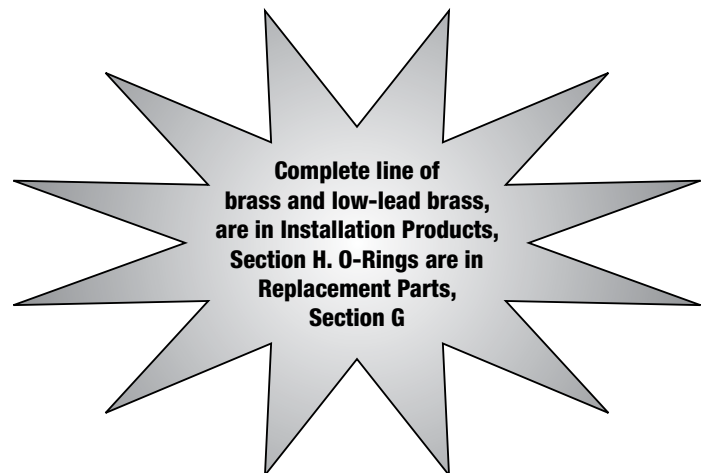



## John Guest Fittings (Bag of 10)



Superseal x Tube

Part #	Size"	Description
PI0406S	(2) 3/16	Union, tube OD
PI0408S	(2) 1/4	Union, tube OD
PM0408S	(2) 5/16	Union, tube OD
PI0412S	(2) 3/8	Union, tube OD
PI0416S	(2) 1/2	Union, tube OD
PI200806S	1/4 x 3/16	Reducing union, tube OD
PI201006S	5/16 x 3/16	Reducing union, tube OD
PI201008S	5/16 x 1/4	Reducing union, tube OD
PI201206S	3/8 x 3/16	Reducing union, tube OD
PI201208S	3/8 x 1/4	Reducing union, tube OD
PI201210S	3/8 x 5/16	Reducing union, tube OD
PI201610S	1/2 x 5/16	Reducing union, tube OD
PI201612S	1/2 x 3/8	Reducing union, tube OD
SI270808S	(2) 1/4	Union, Superseal x tube OD
SI041212S	(2) 3/8	Union, Superseal x tube OD
SI271008S	5/16 x 1/4	Union, Superseal x tube OD
SI271208S	3/8 x 1/4	Union, Superseal x tube OD



PI010822S	(2) 1/4	Tube OD x MPT
PI010823S	1/4 x 3/8	Tube OD x MPT
PI011222S	3/8 x 1/4	Tube OD x MPT
PI011223S	(2) 3/8	Tube OD x MPT
PI011224S	3/8 x 1/2	Tube OD x MPT
PI011623S	1/2 x 3/8	Tube OD x MPT
PI011624S	(2) 1/2	Tube OD x MPT
PI010802S	(2) 1/4	Male connector OD tube x BSPT
PI011203S	(2) 3/8	Male connector OD tube x BSPT
PI011603S	1/2 x 3/8	Male connector OD tube x BSPT



PI0108F4S	(2) 1/4	Tube OD x MFL
PI0112F4S	3/8 x 1/4	Tube OD x MFL
PI0112F6S	(2) 3/8	Tube OD x MFL
PI0112F8S	3/8 x 1/2	Tube OD x MFL
PI0116F8S	(2) 1/2	Tube OD x MFL



PI450822S	(2) 1/4	Connector, tube OD x FPT
PI451222S	3/8 x 1/4	Connector, tube OD x FPT

For more information visit [www.johnguest.com](http://www.johnguest.com)



Superseal x Speedfit



Superseal x Superseal

Part #	Size"	Description
PI0306S	(2) 3/16	Elbow, tube OD
PI0308S	(2) 1/4	Elbow, tube OD
PM0308S	(2) 5/16	Elbow, tube OD
PI0312S	(2) 3/8	Elbow, tube OD
PI0316S	(2) 1/2	Elbow, tube OD
PI211006S	5/16 x 3/16	Reducing elbow, tube OD
PI211008S	5/16 x 1/4	Reducing elbow, tube OD
PI211206S	3/8 x 3/16	Reducing elbow, tube OD
PI211208S	3/8 x 1/4	Reducing elbow, tube OD
PI211210S	3/8 x 5/16	Reducing elbow, tube OD
PI211610S	1/2 x 5/16	Reducing elbow, tube OD
PI211612S	1/2 x 3/8	Reducing elbow, tube OD
SI031212S	(2) 3/8	Elbow, Superseal x Speedfit
SI401210S	3/8 x 5/16	Elbow, Superseal x Superseal
SI401212S	(2) 3/8	Elbow, Superseal x Superseal



PI220808S	1/4 x 1/4	Plug-in elbow, stem OD x tube OD
PI221208S	3/8 x 1/4	Plug-in elbow, stem OD x tube OD
PI221212S	3/8 x 3/8	Plug-in elbow, stem OD x tube OD
PI221616S	1/2 x 1/2	Plug-in elbow, stem OD x tube OD



NC35602	(2) 3/8	Dispensing valve elbow, tube OD x stem OD
---------	---------	---



NC73002	3/8	Dispensing valve stem, stem OD
---------	-----	--------------------------------



PI061208S	3/8 x 1/4	Reducer, stem OD x tube OD
PI061612S	1/2 x 3/8	Reducer, stem OD x tube OD



PI4608S	1/4	End stop, tube OD
---------	-----	-------------------



PI4512F4S	3/8 x 1/4	Connector, tube OD x FFL
PI4512F6S	(2) 3/8	Connector, tube OD x FFL
PI4516C5S	1/2 x 5/8	Connector, tube OD x BSPP cone end

For more information visit [www.johnguest.com](http://www.johnguest.com)

## John Guest Fittings (Bag of 10)



Part #	Size"	Description
PI090802S	(2) 1/4	Swivel elbow, tube OD x BSPT
PI090822S	(2) 1/4	Swivel elbow, tube OD x MPT
PI091222S	3/8 x 1/4	Swivel elbow, tube OD x MPT
PM090822S	5/16 x 1/4	Swivel elbow, tube OD x MPT
PI091223S	(2) 3/8	Swivel elbow, tube OD x MPT
PI091622S	1/2 x 1/4	Swivel elbow, tube OD x MPT
PI091623S	1/2 x 3/8	Swivel elbow, tube OD x MPT
PI091624S	(2) 1/2	Swivel elbow, tube OD x MPT



PI110822S	1/4 x 1/4	Swivel male run tee, tube OD x MPT
PI111222S	3/8 x 1/4	Swivel male run tee, tube OD x MPT
PI111223S	3/8 x 3/8	Swivel male run tee, tube OD x MPT
PI111623S	1/2 x 3/8	Swivel male run tee, tube OD x MPT
PI111624S	1/2 x 1/2	Swivel male run tee, tube OD x MPT



PI480821S	1/4 x 1/8	Elbow, tube OD x MPT
PI480823S	1/4 x 3/8	Elbow, tube OD x MPT
PI481222S	3/8 x 1/4	Elbow, tube OD x MPT
PI481223S	(2) 3/8	Elbow, tube OD x MPT



PM2308S	5/16	Two-way divider, tube OD
PI2312S	3/8	Two-way divider, tube OD
PI2316S	1/2	Two-way divider, tube OD



PIUB12S	3/8	U-bend, tube OD
PIUB16S	1/2	U-bend, tube OD



PI491612S	1/2 x 3/8	3 way divider, tube OD inlet x tube OD outlet
-----------	-----------	---



PI291208S	3/8 x 1/4	Tube to hose elbow, stem OD x hose ID
-----------	-----------	---------------------------------------



Part #	Size"	Description
PI0206S	(3) 3/16	Tee, tube OD
PI0208S	(3) 1/4	Tee, tube OD
PM0208S	(3) 5/16	Tee, tube OD
PI0212S	(3) 3/8	Tee, tube OD
PI0216S	(3) 1/2	Tee, tube OD
PI301208S	3/8 x 1/4	Reducing tee, tube OD
PI301612S	1/2 x 3/8	Reducing tee, tube OD



PI100822S	1/4 x 1/4	Swivel tee, tube OD x MPT
PI101623S	1/2 x 3/8	Swivel tee, tube OD x MPT
PI101624S	1/2 x 1/2	Swivel tee, tube OD x MPT



PI250806S	1/4 x 3/16	Adapter, stem OD x hose ID
PI250808S	(2) 1/4	Adapter, stem OD x hose ID
PI250810S	1/4 x 5/16	Adapter, stem OD x hose ID
PM250808S	(2) 5/16	Adapter, stem OD x hose ID
PI251006S	5/16 x 3/16	Adapter, stem OD x hose ID
PI251012S	5/16 x 3/8	Adapter, stem OD x hose ID
PI251208S	3/8 x 1/4	Adapter, stem OD x hose ID
PI251210S	3/8 x 5/16	Adapter, stem OD x hose ID
PI251212S	(2) 3/8	Adapter, stem OD x hose ID
PI251216S	3/8 x 1/2	Adapter, stem OD x hose ID
PI251612S	1/2 x 3/8	Adapter, stem OD x hose ID
PI251616S	(2) 1/2	Adapter, stem OD x hose ID



PI0806S	3/16	Plug, stem OD
PI0808S	1/4	Plug, stem OD
PM0808S	5/16	Plug, stem OD
PI0812S	3/8	Plug, stem OD
PI0816S	1/2	Plug, stem OD



PI051222S	3/8 x 1/4	Adapter, stem OD x MPT
PI051223S	(2) 3/8	Adapter, stem OD x MPT
PI051623S	1/2 x 3/8	Adapter, stem OD x MPT
PI051604S	(2) 1/2	Adapter, stem OD x BSPT

For more information visit [www.johnguest.com](http://www.johnguest.com)

## John Guest Fittings (Bag of 10)

Part #	Size"	Description
3/8SCV	3/8	Check valve, tube OD
		
CI0412W	3/8	White acetal union connector
		
PP010821W	1/4 x 1/8	Straight adapter, tube OD x MPT
PP010822W	(2) 1/4	Straight adapter, tube OD x MPT
PP011223W	(2) 3/8	Straight adapter, tube OD x MPT
PP011224W	3/8 x 1/2	Straight adapter, tube OD x MPT
		
PP3208U7W	1/4 x 7/16	Faucet connector tube OD x 7/16-24 UNS
		
PP451223W	(2) 3/8	Female adapter, tube OD x FPT
		
PP220808W	(2) 1/4	Plug-in elbow, stem OD x tube OD
PP221212W	(2) 3/8	Plug-in elbow, stem OD x tube OD
		
PP480821W	1/4 x 1/8	Elbow, tube OD x MPT
PP480822W	(2) 1/4	Elbow, tube OD x MPT
		
PP0308W	(2) 1/4	Elbow, tube OD
PP0312W	(2) 3/8	Elbow, tube OD
		
ASV3	15mm x 1/4	Acetal tee valve, tube OD x tube OD branch
ASV4	15mm x 3/8	Acetal tee valve, tube OD x tube OD branch
		
PP0208W	(3) 1/4	Tee, tube OD
PP30121208W	(2) 3/8 x 1/4	Tee, tube OD
PP0212W	(3) 3/8	Tee, tube OD
		
SVMC-10		Mounting clip acetal



Part #	Size"	Description
PPSV040808W	(2) 1/4	Speedfit to Speedfit
PPSV041212W	(2) 3/8	Speedfit to Speedfit



PPSV011223W	(2) 3/8	Speedfit to MPT
-------------	---------	-----------------



Short handle



Long handle

PISV0412CS	(2) 3/8	Shut-off valve short handle
PISV0412S	(2) 3/8	Shut-off valve long handle
PISV0416S	(2) 1/2	Shut-off valve long handle



PASVPP1	3/8 x 3/8 x 1/4	Angle stop adapter valve, male compression x female compression x tube OD
---------	-----------------	---

ASVPP2	(3) 3/8	Angle stop adapter valve, male compression x female compression x tube OD
--------	---------	---



PASVPP5	1/2 x 3/8 x 1/4	Female conversion adapter 1/2 male thread compression x 1/4 female thread compression
---------	-----------------	---

PASVPP6	1/2 x 3/8 x 3/8	Female conversion adapter 1/2 male thread compression x 3/8 female thread compression
---------	-----------------	---



MI4508F4S	(2) 1/4	Brass flare connector, tube OD x FFL
MI4512F4S	3/8 x 1/4	Brass flare connector, tube OD x FFL



NC2258	3/8 x 3/4-11.5 NH	Brass garden hose connector, tube OD x NH national hose thread
--------	-------------------	--

NC2098	1/4 x 3/4-11.5 NH	Brass garden hose connector, tube OD x NH national hose thread
--------	-------------------	--



NC2249LF	3/8 x 3/4	Brass OD tube x BSPP thread female connector
----------	-----------	--



PIC1808R	1/4	Locking clip
PIC1812R	3/8	Locking clip
PIC1816R	1/2	Locking clip

For more information visit [www.colder.com](http://www.colder.com)

## Colder Quick Couplings

Plastic couplings have two parts, body and insert, which are sold separately to provide more combination options. Coupling bodies feature a thumb latch which clicks when connected.

Inline ferruleless compression terminations are for use with semi-rigid plastic tubing which must meet stated inside and outside diameters. Compression terminations (ends) are for use with copper or semi-rigid plastic tubing. Elbows pivot to avoid kinks or unnecessary bends in the fluid lines.

### Coupling Bodies

Part #	Size"	Description
44400	1/4	Body, straight thru, MPT
45600	1/4	Body, shut-off, MPT
49200	3/8	Body, straight thru, MPT
45700	3/8	Body, shut-off, MPT
45500	3/8	Body, shut-off, 45° FFL
49300	1/4 OD .170 ID	Body, straight thru, inline compression
43200	1/4 OD .170 ID	Body, shut-off, inline compression
49400	3/8 OD .250 ID	Body, straight thru, inline compression
43300	3/8 OD .250 ID	Body, shut-off, inline compression
46000	1/4 ID	Body, shut-off, compression end
46100	3/8 ID	Body, shut-off, compression end
40700	1/4 ID	Body, straight thru, barb
42100	1/4 ID	Body, shut-off, barb
42200	3/8 ID	Body, shut-off, barb
70800	1/4	SS valved barb inline coupling body
76500	3/8	SS valved barb inline coupling body
99000	3/8 ID	Dispensing body, inline, barb
95600	1/2 ID	Dispensing body, inline, barb
99100	5/8 ID	Dispensing body, inline, barb
99200	3/4 ID	Dispensing body, inline, barb
99300	3/8 ID	Dispensing body, elbow, barb
95400	1/2 ID	Dispensing body, elbow, barb
95800	38 mm	Cap, valve, without thread seal
95801	38 mm	Cap, valve, with thread seal
96000	1/2 ID	Clean-in-place (CIP) adapter, inline, barb

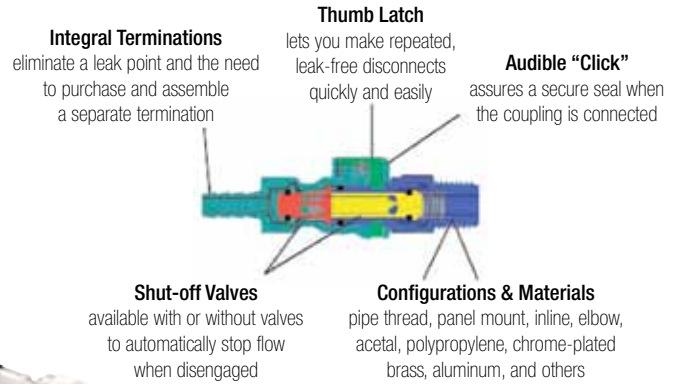
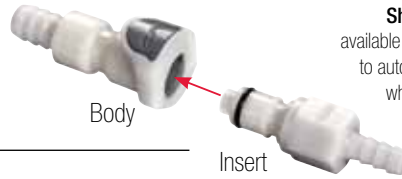

### Coupling Inserts

Part #	Size"	Description
42300	1/4	Insert, straight thru, MPT
42400	1/4	Insert, shut-off, MPT
42500	3/8	Insert, straight thru, MPT
48600	3/8	Insert, shut-off, MPT
43400	1/4 OD .170 ID	Insert, shut-off, inline compression
43500	3/8 OD .250 ID	Insert, shut-off, inline compression
44900	1/4	Insert, shut-off, compression end
45000	3/8	Insert, shut-off, compression end
40900	1/4 ID	Insert, straight thru, barb
42600	1/4 ID	Insert, shut-off, barb
41000	3/8 ID	Insert, straight thru, barb
42700	3/8 ID	Insert, shut-off, barb
49500	1/4 OD .170 ID	Insert, straight thru, elbow, compression end
43000	1/4 OD .170 ID	Insert, shut-off, elbow, compression end
49600	3/8 OD .250 ID	Insert, straight thru, elbow, compression end
43100	3/8 OD .250 ID	Insert, shut-off, elbow, compression end
46200	1/4 ID	Insert, straight thru, elbow, barb
44700	3/8 ID	Insert, straight thru, elbow, barb
42900	3/8 ID	Insert, shut-off, elbow, barb
70500	1/4	SS valved barb inline insert
70900	3/8	SS valved barb inline insert



## Plastic Fittings



Part #	Size"	Description
33005	(2) 1/4	Adapter, barb x MPT
33006	1/4 x 3/8	Adapter, barb x MPT
33007	1/4 x 1/2	Adapter, barb x MPT
33380	1/4 x 3/4	Adapter, barb x MPT
33011	3/8 x 1/8	Adapter, barb x MPT
33012	3/8 x 1/4	Adapter, barb x MPT
33013	3/8 x 3/8	Adapter, barb x MPT
33014	3/8 x 1/2	Adapter, barb x MPT
33026	3/8 x 3/4	Adapter, barb x MPT
33026B	3/8 x 3/4	Bulk adapter, barb x MPT
33015	1/2 x 1/4	Adapter, barb x MPT
33016	1/2 x 3/8	Adapter, barb x MPT
33017	(2) 1/2	Adapter, barb x MPT
33018	1/2 x 3/4	Adapter, barb x MPT
33019	5/8 x 3/8	Adapter, barb x MPT
33020	5/8 x 1/2	Adapter, barb x MPT
33021	5/8 x 3/4	Adapter, barb x MPT
33022	3/4 x 1/2	Adapter, barb x MPT
33023	(2) 3/4	Adapter, barb x MPT
33000	3/4 x 1	Adapter, barb x MPT
33024	1 x 3/4	Adapter, barb x MPT
33025	1 x 1	Adapter, barb x MPT
33029	1 x 1-1/4	Adapter, barb x MPT
33028	1-1/4 x 1	Adapter, barb x MPT



430-101-45



830-101SR

Part #	Size"	Description
430-101-45	3/4 x 1/2	FPT PVC SCH 40 coupling
830-101SR	3/4 x 1/2	FPT PVC SCH 80 SS reinforced
829101	3/4 x 1/2	Slip PVC SC 80 reducer



05-0011	1/4	Nylon flare washer
05-0012	5/16	Nylon flare washer
05-0017	3/8	Nylon flare washer
05-0018	1/2	Nylon flare washer



3998290	1/4	In-line plastic barb shut-off
5740990	3/8	In-line plastic barb shut-off
6885190	1/2	In-line plastic barb shut-off



28668P	3/4 x 1/2	Polypropylene hex bushing
TP-4006	3/8"	NPT plug, HDPE



05-2588	1/4, 3/8 & 1/2	Plug, barb, plastic
05-1385	1/8	Plastic elbow, Dole x 1/8 barb

## Cleaners and Cleaning Equipment



1842: 1 quart cleaning kit includes 1841 cleaner, 905W 3/4" faucet brush, 904A 3/16" ID hose brush, 4350 faucet coupling nut, spanner wrench, BLC cleaning solution, Draft Beer booklet, ball lifter, and FT584 pump.



CP151040-KIT

CP151060

CP151061

CP151054/55/56



2.5 gal cleaning can

5.0 gal cleaning can



82-4354



82-4355



CP151100  
Sockets sold separately



JS300



JS350



8005-913-289



MR-60



DSK-1000

Part #	Description
1841	1 quart cleaning jar with FT584 pump
1842	1 quart complete cleaning kit with FT584 pump
1842G	1 quart complete gravity cleaning kit
CP151040	1 quart plastic cleaning bottle with metal pump
CP151040-KIT	1 quart plastic cleaning bottle with metal pump, faucet wrench and brush, 4 oz bottle of beer line cleaner
CP151054	1.3 gallon/5 liter plastic cleaning bottle
CP151055	15 Litre Cleaning Bottle
CP151056	30 Litre Cleaning Bottle
CP151060	"D" system plastic cap for plastic cleaning bottle
CP151061	"G" system plastic cap for plastic cleaning bottle
CP151062	"U" system plastic cap for plastic cleaning bottle
CP151063	"S" system plastic cap for plastic cleaning bottle
CP151064	"A" system plastic cap for plastic cleaning bottle
CP151065	"M" system plastic cap for plastic cleaning bottle
CP151011	5.0 gal SS cleaning can with 2 "D" and 2 "U" valves
CP151012	5.0 gal SS cleaning can with 3 "D" and 1 "S" valve
CP151013	5.0 gal SS cleaning can with 2 "D", 1 "S", and 1 "A" valve
CP151014	5.0 gal SS cleaning can with 2 "D", 1 "S", and 1 "U" valve
CP151031	5.0 gal SS cleaning can with 4 "D" system valves
CP150980	2.5 gal SS cleaning can with 2 "D" valves
CP150984	2.5 gal SS cleaning can with 1 "D" and 1 "U" valve
CP150985	2.5 gal SS cleaning can with 1 "A" and 1 "S" valve
CP150987	2.5 gal SS cleaning can with 2 "A" valves
CP151100	In-place portable cleaning system SS mounting bd with handle
CP151130	In-place portable cleaning system "D" socket
CP151132	In-place portable cleaning system "S" socket
CP151133	In-place portable cleaning system "U" socket
CP151134	In-place portable cleaning system "A" socket
CP151135	In-place portable cleaning system "G" socket
CP151140	In-place portable cleaning system back plate
CP151142	In-place portable cleaning system end stop cap
82-4354	CIP chemical dosing board
82-4355	CIP pump board assy
JS300	Line cleaning equipment, medium duty
JS350	Line cleaning equipment, heavy duty
8005-913-289	Electric pump, beer cleaning system
22010	Rieke MR-60 drum pump
22020	Rieke MR-50 drum pump
DSK-1000	Draft service repair kit

## Cleaners and Cleaning Equipment



Part #	Description
70380	Faucet spanner wrench with red handle
4350	Spanner wrench no grip
4350S	Spanner wrench with black grip
BB101725	Euro faucet wrench
BB101727	6 in 1 Perlick combination wrench
D4740-W	Wrench set for draft towers, side and center access, 1-1/16 x 1"
905W	Faucet brush, nylon, 3/4" x 3" x 8-1/2" long
C217	Faucet cleaning brush - single sided
CB37	Faucet and shank brush, double sided
1032	Nozzle brush
22-0017	Brush, valve nozzle
904A	Hose brush, 3/16" x 66" long
904B	Hose brush, 1/4" x 66" long
904C	Hose brush, 3/8" x 66" long
904D	Hose brush, 1/2" x 66" long
905WL	Brush 5/8" x 3" x 14" long
C148	Jet Carboy bottle washer
C169	Carboy handle, 5 gallon
C170	Carboy handle, 6.5 gallon
C248	Faucet adapter for Jet Carboy washer
C299	Faucet cleaning attachment - fixed
4353	Cleaning attachment, 5/16" barb
902	Duplex cleaning coupler
48-3073	Washout tee assy, SS 1 way
48-3074	Washout tee assy, SS 2 way
C156	Faucet and shank cleaning attachment
FT115BA	Series cleaning adapter
C395	Sankey cleaning adapter
C400	Keg coupler check ball lifter
FT108	Single flusher for single hole keg valve taps
FT110AB	Double flusher for single hole keg valve taps
FT109S	Double flusher adaptor. Beer thread ends permit 2 single flushers to be coupled to form a double flusher
FT874C	Cap and washer, used on male beer thread end of a single flusher to convert to series tap cleaning
CB45	Kleen plug with brush
CP101550	Beer faucet spout plug
C182	Beer faucet spout plug, box of 100

## Cleaners and Cleaning Equipment



Part #	Description
CC401L	Plastic series cleaning cup, no ball lifter
CP101690	SS series flusher "G"
CP101692	Plastic series flusher "U"
CP101693	SS series flusher "A"
CP101694	Single flusher "A"
CP101698	Lexan series flusher "D" and "S" no ball lifter
CP101699	SS series flusher "D" and "S" with integral ball lifter
CP101700	SS series flusher "D" and "S" no ball lifter
CP101716	Faucet cleaning attachment with barb
CP101716-22	Washer for CP101716 cleaning attachment
CP151068	5 litre dip tube
CP151069	15 litre dip tube
CP151070	30 litre dip tube

Beer line cleaner is sold in case quantities, 12 bottles per case. Price breaks for 2-5 cases, 6-20 cases, and 21 or more cases. Pallet quantities are also available.

Hazardous material shipping charges apply when shipping UPS, FedEx, or LTL.

Part #	Description
222	Draftec beer line cleaner clear 32 oz bottles 12/case
222-15	Draftec beer line cleaner clear 15 gallon
222-30	Draftec beer line cleaner clear 30 gallon
222-5	Draftec beer line cleaner clear 5 gallon
222-55	Draftec beer line cleaner clear 55 gallon
444	Draftec beer line acid cleaner clear 32 oz bottles 12/case
444-15	Draftec beer line acid cleaner clear 15 gallon
444-30	Draftec beer line acid cleaner clear 30 gallon
444-5	Draftec beer line acid cleaner clear 5 gallon
444-55	Draftec beer line acid cleaner clear 55 gallon
222B	Draftec beer line cleaner blue tracer 32 oz bottles 12/case
222B-15	Draftec beer line cleaner blue tracer 15 gallon
222B-30	Draftec beer line cleaner blue tracer 30 gallon
222B-5	Draftec beer line cleaner blue tracer 5 gallon
222B-55	Draftec beer line cleaner blue tracer 55 gallon
444R	Draftec beer line cleaner red tracer 32 oz bottles 12/case
444R-15	Draftec beer line cleaner red tracer 15 gallon
444R-30	Draftec beer line cleaner red tracer 30 gallon
444R-5	Draftec beer line cleaner red tracer 5 gallon
444R-55	Draftec beer line cleaner red tracer 55 gallon
MBS-5	Draftec master brewers standard tank and keg cleaner 5 gallon
MBS-15	Draftec master brewers standard tank and keg cleaner 15 gallon
MBS-30	Draftec master brewers standard tank and keg cleaner 30 gallon
MBS-55	Draftec master brewers standard tank and keg cleaner 55 gallon
MBSA-5	Draftec master brewers standard acid tank and keg cleaner 5 gallon
MBSA-15	Draftec master brewers standard acid tank and keg cleaner 15 gallon
MBSA-30	Draftec master brewers standard acid tank and keg cleaner 30 gallon
MBSA-55	Draftec master brewers standard acid tank and keg cleaner 55 gallon
24041	Kay-5 sanitizer (8) 1 oz. packets per bag
CP103100	T.M. Desana Max 1.9 oz packet



Draftec beer line cleaner



**Cleaners and Cleaning Equipment**

Liquid sugar below 75° F forms sugar crystals. Syrup and juice sugar crystals build up and impair the performance of beverage dispensers, bag-in-box adapters, pumps, circulating coils, valves, mixing chambers and nozzles. Micro-organisms grow in any area exposed to sugar, water and air and can flush into drinks. Over time moving parts with sugar crystal and bacteria build-up fail to work properly and affect the quality of the drink.

**Without Cleaning**

- Quality suffers, customers are dissatisfied, drinks are often repoured or discarded, profits decrease
- Syrup or juice concentrate can be mistakenly blamed for poor quality and good boxes of syrup or concentrate are returned or discarded
- Dispensing may be stopped depending on the severity of the problem, and service agents may not be able to respond quickly
- Brush cleaning will help but cannot reach all build-up areas

**With Regular Cleaning**

- Consistent quality drinks are poured and customers are satisfied, profits increase
- Sugar crystals and bacteria are removed from the entire system, including areas brush cleaning can't reach
- Flow controls and metering stems operate at optimum performance
- BevClean's inhibitor prevents growth and deposits for 60-90 days after cleaning
- Cleaning time is scheduled during off hours, service calls are reduced; replacement parts and labor costs decrease

**Before and After Cleaning**



Part #	Description
216578	BevClean BIB cleaner, 3 gallon box
219000	BevClean BIB cleaner, 55 gallon drum
216673	Super BevClean, 1 gallon
216701	WinterBev solution, 5 gallons
219701	WinterBev solution, 50 gallon drum

**BevClean™ No Rinse Bag-in-Box System Cleaner**



Cleans everything from the rack to the dispensing point, one line at a time, or up to 8 lines at a time with the BevClean manifold.

**No More** buckets, mixing, waiting for powders to dissolve in the correct temperature of water, waiting for the cleaner to work and then flushing, which can take up to 1 hour per line.

Simply hook the bag connector to the BevClean BIB box, open the dispensing valve until clear BevClean is detected, re-attach the syrup BIB and dispense until the line is full of syrup again. With the manifold assembly you can clean up to 8 lines simultaneously in 15-20 minutes!

BevClean works on contact, is completely safe, leaves no residuals, and inhibits growth and deposits for 60-90 days after cleaning.



WinterBev is a beverage system antifreeze (propylene glycol base) packaged in 5 gallon BIB boxes, ideal for seasonal equipment, or equipment in cold storage. Protects to -11° F. Available in stronger concentrate for extreme low temperatures.

U.S. Dept. of Health and Human Services, Public Health Service, FDA 2001 Food Code Cleaning Requirement, updated April 2004:

- 4-701.10 Sanitization of Equipment and Utensils:  
"Equipment food-contact surfaces and utensils shall be sanitized."
- 4-601.11(C) Cleaning of Equipment and Utensils:  
"Non-food contact surfaces of equipment shall be kept free of an accumulation of dust, dirt, food residue, and other debris."
- 4-602.11 (E-4) Cleaning Frequency:  
"In equipment such as ice bins and beverage dispensing nozzles and enclosed components of equipment such as ice makers ... beverage and syrup dispensing lines or tubes ... and water vending equipment:  
(a) At a frequency specified by the manufacturer, or  
(b) Absent manufacturer specifications, at a frequency necessary to preclude accumulation of soil or mold."

## Cleaners and Cleaning Equipment



Part #	Description
4291-18	Nu-Brite® condenser coil cleaner, 18 oz. can
4291-08	Nu-Brite® condenser coil cleaner, 1 gallon bottle
4291-05	Nu-Brite® condenser coil cleaner, 2.5 gallon pail
4291-01	Nu-Brite® condenser coil cleaner, 55 gallon drum
4178-08	Foam-Brite® alkaline condenser coil cleaner, 1 gal bottle
4178-05	Foam-Brite® alkaline condenser coil cleaner, 2.5 gal pail
4178-01	Foam-Brite® alkaline condenser coil cleaner, 55 gal drum
4120-08	Alka-Brite® Plus non-acid, alkaline based condenser coil cleaner, 1 gallon bottle
4120-01	Alka-Brite® Plus non-acid, alkaline based condenser coil cleaner, 55 gallon drum
4171-75	Evap Foam No Rinse® detergent for cooling and evaporator coils, 18 oz. can
4290-75	Nu-Blast® condenser coil cleaner, 18 oz. can
4132-20	Cal-Blast® no rinse condenser cleaner, 20 oz. can
4190-08	Cal-Green™ condenser cleaner, 1 gallon bottle
4190-01	Cal-Green™ condenser cleaner, 55 gallon drum
4191-08	Evap-Green™ evaporator cleaner, 1 gallon bottle
4191-01	Evap-Green™ evaporator cleaner, 55 gallon drum
4166-75	Evap Fresh™ No Rinse evaporator coils cleaner and disinfectant, 18 oz. can
4081-75	CalClean® alkaline cleaner for fan blades, coils, metal filters, etc., 20 oz. can
4135-08	CalClean® alkaline cleaner for fan blades, coils, metal filters, etc., 1 gallon bottle
4135-06	CalClean® alkaline cleaner for fan blades, coils, metal filters, etc., 2.5 gallon pail
4135-01	CalClean® alkaline cleaner for fan blades, coils, metal filters, etc., 55 gallon drum
4186-24	Green Clean all-purpose cleaner, 1 qt spray bottle
4186-08	Green Clean all-purpose cleaner, 1 gallon bottle
4186-01	Green Clean all-purpose cleaner, 55 gallon drum
4185-05	Gel Tabs condensate drain pan treatment, 5 ton tab (6/tube)
4185-03	Gel Tabs condensate drain pan treatment, 3 ton tab (12/tube)
4185-15	Gel Tabs condensate drain pan treatment, 15 ton tab (1 ea)
4185-20	Gel Tabs condensate drain pan treatment, 20 ton tab (1 ea)
4082-03	Electrical Contact Cleaner spray, 11 oz. can
4082-04	Electrical Contact Cleaner spray, low VOC for CA, 14 oz. can
4083-75	Degreasing Solvent EF, 14 oz. can
4083-83	Degreasing Solvent EF, low VOC for CA, 14 oz. can
4287-34	Nickel-Safe ice machine cleaner, 16 oz. bottle
4287-08	Nickel-Safe ice machine cleaner, 1 gallon bottle
4207-47	Liquid ice machine cleaner, 8 oz. bottle
4207-08	Liquid ice machine cleaner, 1 gallon bottle
4211-34	IMS-II sanitizing concentrate, 16 oz. bottle

## Underbar Ice Chests

Seamless top/backsplash can be ordered with an optional tubing chase in the backsplash (TC-BS). Plastic breaker strip around the ice bin liner acts as a thermal barrier and makes the stainless steel covers slide easier. Fully insulated. Models without cold plates have a 1.5" welded tailpiece so there's no drain fitting to break or come loose. Freestanding ice bins come with adjustable stainless steel bullet feet. Drop-ins have studs for mounting to countertop. Made to order and not returnable.

Prefixes: IBA = 19" deep, IBB = 24" deep, IB = pass-thru

DI-IS = drop-in & sink, DI-DIS = drop-in, sink & drainboard

DI-WS = drop-in & water station

DI-DIW = drop-in, water station & drainboard

Suffix: ED = Extra deep 14-1/2" bin liner, LF = no faucet



More details available. Please visit [www.glastender.com](http://www.glastender.com)

\*Made to order and not returnable.

Part #	Length"	Depth"	Cold Plate	Lbs. Ice Capacity
IBA-6*	6	19	N/A	17
IBA-12*	12	19	N/A	33
IBA-18*	18	19	N/A	50
IBA-24*	24	19	N/A	67
IBA-30*	30	19	N/A	84
IBA-36*	36	19	N/A	100
IBA-42*	42	19	N/A	117
IBA-48*	48	19	N/A	134
IBA-24-CP10	24	19	10 circuit	67
IBA-30-CP10	30	19	10 circuit	84
IBA-36-CP10	36	19	10 circuit	100
IBA-42-CP10	42	19	10 circuit	117
IBA-48-CP10	48	19	10 circuit	134
IBA-18-ED	18	19	N/A	69
IBA-24-ED	24	19	N/A	92
IBA-30-ED	30	19	N/A	116
IBA-36-ED	36	19	N/A	139
IBA-42-ED	42	19	N/A	162
IBA-48-ED	48	19	N/A	185
IBA-24-CP10-ED*	24	19	10 circuit	92
IBA-30-CP10-ED*	30	19	10 circuit	116
IBA-36-CP10-ED*	36	19	10 circuit	139
IBA-42-CP10-ED*	42	19	10 circuit	162
IBA-48-CP10-ED*	48	19	10 circuit	185
DI-IB12	14	19	N/A	33
DI-IB18	20	19	N/A	50
DI-IB24	26	19	N/A	71
DI-IB30	32	19	N/A	89
DI-IB24-CP10	26	19	10 circuit	71
DI-IB30-CP10	32	19	10 circuit	89

Part #	Length"	Depth"	Cold Plate	Lbs. Ice Capacity
IBB-6*	6	24	N/A	21
IBB-12*	12	24	N/A	42
IBB-18*	18	24	N/A	64
IBB-24*	24	24	N/A	85
IBB-30*	30	24	N/A	106
IBB-36*	36	24	N/A	127
IBB-42*	42	24	N/A	149
IBB-48*	48	24	N/A	170
IBB-24-CP10*	24	24	10 circuit	85
IBB-30-CP10*	30	24	10 circuit	106
IBB-36-CP10*	36	24	10 circuit	127
IBB-42-CP10*	42	24	10 circuit	149
IBB-48-CP10*	48	24	10 circuit	170
IBB-24-CP10-ED	24	24	10 circuit	117
IBB-30-CP10-ED	30	24	10 circuit	147
IBB-36-CP10-ED	36	24	10 circuit	176
IBB-42-CP10-ED	42	24	10 circuit	205
IBB-48-CP10-ED	48	24	10 circuit	235
IB-38X24*	38	24	N/A	175
IB-38X24-CP10	38	24	10 circuit	175
DI-IS24	24	19	N/A	92
DI-IS24-LF	24	19	N/A	92
DI-DIS42	42	19	N/A	117
DI-DIS42-LF	42	19	N/A	117
DI-IW24	24	19	N/A	92
DI-IW24-LF	24	19	N/A	92
DI-DIW42	42	19	N/A	117
DI-DIW42-LF	42	19	N/A	117
TC-BS	Backsplash tubing chase 2.38 x 4" for IB & CB bins			

See page 136 for speed rails

## Underbar Combo Ice Bin/Bottle Well

More details available. Please visit [www.glastender.com](http://www.glastender.com)

Separate draining ice bin and bottle well compartment are combined into one insulated stainless steel unit. Seamless top/backsplash can be ordered with an optional tubing chase in the backsplash (TC-BS). Plastic breaker strip around the ice bin liner acts as a thermal barrier and makes the stainless steel covers slide easier. Order with or without a 10 circuit cold plate. Part numbers ending with -ED have an extra deep ice bin liner

allowing more ice.

Fully insulated 12" bottle well has two wire racks for ice chilled storage of 6 or 8 bottles in 19" or 24" deep ice bins. The bottle well may be located on the left, right, or both sides of the ice bin for 12 or 16 bottle capacity (for both sides omit R or L in part number). **Please specify bottle well location: right R or left L in the part # when ordering.**



TC-BS tubing chase

Combo ice bin with single speed rail



CCD  
condiment  
dispenser



BW3 bottle well



BR3 bottle rack

### Part Number Description

BW3	Bottle well for 19" deep ice bin	Made to order and not returnable.
BW4	Bottle well for 24" deep ice bin	
BR3	Bottle rack for 19" deep ice bin	
BR4	Bottle rack for 24" deep ice bin	
SHA-4	19"D soda gun holder, 4" long, 1-10 buttons	
SHA-4-14	19"D soda gun holder, 4" long, 12-14 buttons	
SHA-6	19"D soda gun holder, 6" long, 1-10 buttons	
SHA-6-14	19"D soda gun holder, 6" long, 12-14 buttons	
SHA-4PT	38"D soda gun holder 4" long 1-10 buttons	
SHA-4PT-14	38"D soda gun holder 4" long 12-14 buttons	
SHA-6PT	38"D soda gun holder 6" long 1-10 buttons	
SHA-6PT-14	38"D soda gun holder 6" long 12-14 buttons	
SHB-4	24"D soda gun holder, 4" long, 1-10 buttons	
SHB-4-14	24"D soda gun holder, 4" long, 12-14 buttons	
SHB-6	24"D soda gun holder, 6" long, 1-10 buttons	
SHB-6-14	24"D soda gun holder, 6" long, 12-14 buttons	
TCA	Tubing chase, 6" long, 19" deep	
TCB	Tubing chase, 6" long, 24" deep	
CCD	Condiment dispenser	

**Please specify bottle well location: right R or left L in the part # when ordering.**

Part Number	Length"	Depth"	Cold Plate	Lbs. Ice Capacity	Bottle Capacity
CBA-30_*	30	19	N/A	50	6
CBA-36_*	36	19	N/A	67	6
CBA-42_*	42	19	N/A	84	6
CBA-48_*	48	19	N/A	100	6
CBA-36_-CP10	36	19	10 circuit	84	6
CBA-42_-CP10	42	19	10 circuit	67	12
CBA-48_-CP10	48	19	10 circuit	100	6
CBA-54_-CP10*	54	19	10 circuit	84	12
CBA-60_-CP10*	60	19	10 circuit	100	12
CBA-36_-CP10-ED*	36	19	10 circuit	92	6
CBA-42_-CP10-ED*	42	19	10 circuit	116	6
CBA-48_-CP10-ED*	48	19	10 circuit	139	6
CBB-36_-CP10*	36	24	10 circuit	85	8
CBB-42_-CP10*	42	24	10 circuit	106	8
CBB-48_-CP10*	48	24	10 circuit	127	8
TC-BS	Backsplash tubing chase 2.38 x 4" for IB & CB bins				

\*Made to order and not returnable.

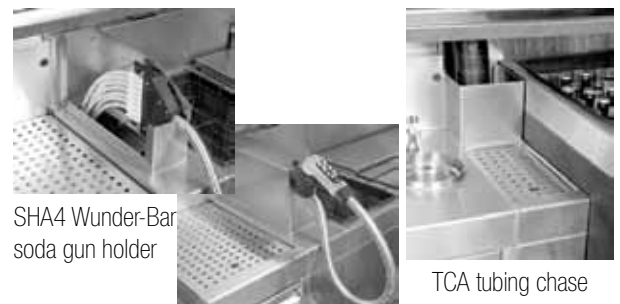

SHA4 Wunder-Bar  
soda gun holder

TCA tubing chase

**See page 136 for speed rails**

## Seamless Top Stations

Combine drainboard, soda gun holder, bottle well, ice bin, and blender station sink into one seamless top and backsplash for an easy to clean, sanitary work surface!

### Features:

- All stainless steel construction and complete line up is flush at 24" deep to match adjacent underbar
- Drainboard cabinet has roll-out bottom shelf and one rollout intermediate shelf
- Drainboard consists of a seamless welded drain pan with separate perforated insert for better air circulation
- Soda gun holder is designed to house a Wunder-Bar® soda gun (10-button or smaller) and includes removable cover for access to soda brix adjustments (soda gun not included), clearance height of 37.5" is required
- Bottle well comes with two wire racks for ice chilled storage of 6 bottles and drains separate from the main ice bin to prevent contamination of ice used to make cocktails
- Bottle well and ice bin are foamed-in-place insulated and include an ABS plastic breaker strip around the liner to prevent thermal transfer so ice lasts longer
- Ice bin includes a built-in ten circuit cold plate and sliding stainless steel cover
- Blender station includes 9.25" x 11.5" x 6" deep sink bowl with hot and cold water faucet and lift-out plastic perforated sink strainer
- Blender shelf has radius interior corners for easy cleaning and is foamed-in-place for extra strength and sound deadening
- Grommited hole on front skirt of blender station for a convenient and safe way to position blender power cord
- Junction box for duplex GFI outlet mounted underneath blender shelf (outlet not included)
- A stainless steel side splash is included between the wet waste sink and ice bin



Seamless top

STS78-CP10  
(Glass racks, soda gun, and blender not included)

Part #	Description
STS72-CP10*	Underbar SS seamless top station with 18" drainboard cabinet and 10 button soda gun holder 72"W x 24"D
STS72-CP10-14*	Underbar SS seamless top station with 18" drainboard cabinet and 14 button soda gun holder 72"W x 24"D
STS78-CP10*	Underbar SS seamless top station with 24" drainboard cabinet and 10 button soda gun holder 78"W x 24"D
STS78-CP10-14*	Underbar SS seamless top station with 24" drainboard cabinet and 14 button soda gun holder 78"W x 24"D

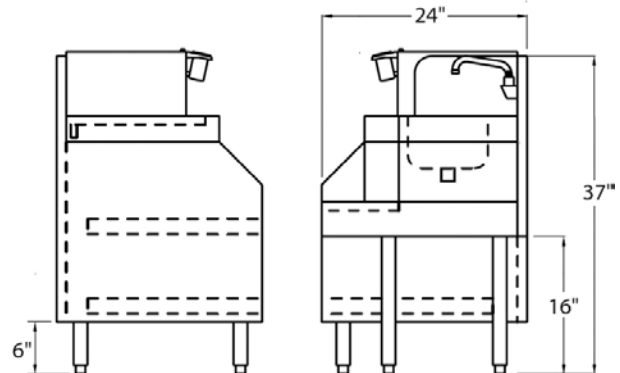

\*Made to order and not returnable.

## Ice Bin Dividers

Part #	Description
IBD-H-A	Ice bin divider, half, for 19" deep ice bin
IBD-H-B	Ice bin divider, half, for 24" deep ice bin
IBD-HA-ED	Ice bin divider, half, for 19" extra deep ice bin
IBD-HB-ED	Ice bin divider, half, for 24" extra deep ice bin
IBD-H-P	Ice bin divider, half, for IB-38X24
IBD-H-P-CP	Ice bin divider, half, for IB-38X24-CP10
IBD-H-P-LR	Ice bin divider, half, left to right for IB-38X24

Ice bin divider half



**See page 136 for speed rails**

## Underbar Blender Stations and Shelves

Blender stations come with a sink, faucet and wet waste strainer. Drainboard blender stations have a drainboard work surface consisting of a drain pan with separate removable perforated insert.

The integral blender shelf is 9" deep on the 24" deep models and 10" deep on the 29" models. The shelf stores the blender at the 19" high level. A grommeted cord access hole is provided in the front skirt.

Blender stations cannot have a speed rail mounted to them. Since speed rails are so common on the underbar, blender stations come in two depths to align with underbars with a speed rail: 24" (to align with 19" deep underbar) and 29" (to align with 24" deep underbar).

Bolt-on blender shelves are 10" deep and include a junction box for duplex outlet (outlet not included) mounted below the shelf.



Bolt-on blender shelf



BSB-18



DBSB-18



IOS-18



IBS-12-H



IBS-12-B



IBS-12-V

More details available. Please visit [www.glastender.com](http://www.glastender.com)

Part #	Length"	Depth"	Description
BSA-12	12	24	Blender station with sink
BSA-14	14	24	Blender station with sink
BSA-18L	18	24	Blender station with sink, left faucet location
BSA-18R	18	24	Blender station with sink, right faucet location
BSB-12	12	29	Blender station with sink
BSB-14	14	29	Blender station with sink
BSB-18	18	29	Blender station with sink
DBSA-12	12	24	Drainboard blender station
DBSA-14	14	24	Drainboard blender station
DBSA-18	18	24	Drainboard blender station
DBSA-24*	24	24	Drainboard blender station
DBSB-12*	12	29	Drainboard blender station
DBSB-14*	14	29	Drainboard blender station
DBSB-18*	18	29	Drainboard blender station
IBS-12-B*	12	24	In-counter blender station for Blendtec™ Smoother, Titan or ABC
IBS-12-H*	12	24	In-counter blender station for Hamilton Beach™ 91655 in-counter blender
IBS-12-V*	12	24	In-counter blender station for Vita-Mix® Touch & Go Blending Station®
IOS-18	18	29	Island Oasis® stand for Island Oasis® machine

\*Made to order and not returnable.

Part Number	Description
LS15-F	15" D left side splash, BSA models
RS15-F	15" D right side splash, BSA models
LS15-D	15" D left side splash, DBSA models
RS15-D	15" D right side splash, DBSA models
LSA-D	19" deep left end splash, BSB & DBSB models
RSA-D	19" deep right end splash, BSB & DBSB models
BBS-8	Bolt-on blender shelf 8"
BBS-12	Bolt-on blender shelf 12"
BBS-14	Bolt-on blender shelf 14"
BBS-16	Bolt-on blender shelf 16"
BBS-18	Bolt-on blender shelf 18"
BBS-24	Bolt-on blender shelf 24"
BBS-30	Bolt-on blender shelf 30"
TR	Towel ring



Towel ring

## Underbar Drainboards

Glastender drainboards have an exclusive 1" deep sloped stainless steel drain pan with a separate removable perforated insert. The 1" high perforated insert allows air circulation beneath the glassware, and since the pan is sloped and not the insert, all glassware is stored on a level plane.

Drainboards are also available with a flat stainless steel fillerboard top in lieu of the drainboard top. Substitute an "F" for the "D" in the model number when ordering (same price). Fillerboards are manufactured to order and not returnable.

Recessed drainboards have the same drain pan with separate perforated insert, but the work surface has been lowered to allow glassware stacking. A perforated shelf is placed on top of the first level of glasses and a second layer is stacked on top (best if only one style of glassware is being stored).

More details available. Please visit [www.glastender.com](http://www.glastender.com)



DBA with  
single  
speed rail

DBA



RDBA

Part #	Length"	Depth"	Description
DBA-12	12	19	Drainboard
DBA-18	18	19	Drainboard
DBA-24	24	19	Drainboard
DBA-30	30	19	Drainboard
DBA-36	36	19	Drainboard
DBA-42	42	19	Drainboard
DBA-48	48	19	Drainboard
DBB-12	12	24	Drainboard
DBB-18	18	24	Drainboard
DBB-24	24	24	Drainboard
DBB-30	30	24	Drainboard
DBB-36	36	24	Drainboard
DBB-42	42	24	Drainboard
DBB-48	48	24	Drainboard
RDBA-12S	12	24	Recessed DB, aligns w 19" UB, single speed rail
RDBA-18S	18	24	Recessed DB, aligns w 19" UB, single speed rail
RDBA-24S	24	24	Recessed DB, aligns w 19" UB, single speed rail
RDBA-30S	30	24	Recessed DB, aligns w 19" UB, single speed rail
RDBB-12	12	24	Recessed DB, aligns w 24" UB w/o speed rail
RDBB-18	18	24	Recessed DB, aligns w 24" UB w/o speed rail
RDBB-24	24	24	Recessed DB, aligns w 24" UB w/o speed rail
RDBB-30	30	24	Recessed DB, aligns w 24" UB w/o speed rail
RDBA-12D	12	29	Recessed DB, aligns w 19" UB, dbl speed rail
RDBA-18D	18	29	Recessed DB, aligns w 19" UB, dbl speed rail
RDBA-24D	24	29	Recessed DB, aligns w 19" UB, dbl speed rail
RDBA-30D	30	29	Recessed DB, aligns w 19" UB, dbl speed rail
RDBB-12S	12	29	Recessed DB, aligns w 24" UB, single speed rail
RDBB-18S	18	29	Recessed DB, aligns w 24" UB, single speed rail
RDBB-24S	24	29	Recessed DB, aligns w 24" UB, single speed rail
RDBB-30S	30	29	Recessed DB, aligns w 24" UB, single speed rail

Part #	Description
SSR-12	12" single speed rail
SSR-18	18" single speed rail
SSR-24	24" single speed rail
SSR-30	30" single speed rail
SSR-36	36" single speed rail
SSR-42	42" single speed rail
SSR-48	48" single speed rail
DSR-12	12" double speed rail
DSR-18	18" double speed rail
DSR-24	24" double speed rail
DSR-30	30" double speed rail
DSR-36	36" double speed rail
DSR-42	42" double speed rail
DSR-48	48" double speed rail
TC*	4" x 4" x 6.5"H tubing chase

\*Units with tubing chase (TC) added are made to order and not returnable.

## Underbar Corner Drainboards

Corner drainboards are used when an underbar line-up turns 90° or less. The direction of the turn may be toward (inside corner) or away (outside corner) from the bartender. Corner drainboards have a removable perforated insert, align with 19" or 24" deep underbars, and come with a front rail to match adjacent equipment.

Dimensional full corner drainboards are for 90° inside turns only. If the dimensions of each side are not the same, the longest dimension is specified second along with its location.

Clip corner drainboards have a larger chamfer than full corner drainboards, and are designed for inside or outside turns 90° or less.

Corner drainboards are designed to mount between two pieces of underbar, however they can be mounted between any two stable vertical surfaces. If one side does not have a vertical surface on which to mount, then a side and leg set must be ordered.

More details available. Please visit [www.glastender.com](http://www.glastender.com)



Clip corner drainboard



Full corner drainboard with chase and perforated insert removed



Full corner drainboard without chase

Part #	Angle	Turn	Description
ICCA-90	90°	Inside	19" deep clip corner
OCCA-90	90°	Outside	19" deep clip corner
ICCA-75	75°	Inside	19" deep clip corner
OCCA-75	75°	Outside	19" deep clip corner
ICCA-60	60°	Inside	19" deep clip corner
OCCA-60	60°	Outside	19" deep clip corner
ICCA-45	45°	Inside	19" deep clip corner
OCCA-45	45°	Outside	19" deep clip corner
ICCA-30	30°	Inside	19" deep clip corner
OCCA-30	30°	Outside	19" deep clip corner
ICCA-15	15°	Inside	19" deep clip corner
OCCA-15	15°	Outside	19" deep clip corner
ICCB-90	90°	Inside	24" deep clip corner
OCCB-90	90°	Outside	24" deep clip corner
ICCB-75	75°	Inside	24" deep clip corner
OCCB-75	75°	Outside	24" deep clip corner
ICCB-60	60°	Inside	24" deep clip corner
OCCB-60	60°	Outside	24" deep clip corner
ICCB-45	45°	Inside	24" deep clip corner
OCCB-45	45°	Outside	24" deep clip corner
ICCB-30	30°	Inside	24" deep clip corner
OCCB-30	30°	Outside	24" deep clip corner
ICCB-15	15°	Inside	24" deep clip corner
OCCB-15	15°	Outside	24" deep clip corner

Part #	Angle	Left"	Right"	Turn	Description
IFCA-90	90°	19	19	Inside	90° full corner drainboard
OFCA-90	90°	19	19	Outside	90° full corner drainboard
IFCB-90	90°	24	24	Inside	90° full corner drainboard
OFCB-90	90°	24	24	Outside	90° full corner drainboard
IFC-19/19	90°	19	19	Inside	Dimensional full corner drainboard
IFC-19/24L	90°	24	19	Inside	Dimensional full corner drainboard
IFC-19/24R	90°	19	24	Inside	Dimensional full corner drainboard
IFC-19/30L	90°	30	19	Inside	Dimensional full corner drainboard
IFC-19/30R	90°	19	30	Inside	Dimensional full corner drainboard
IFC-24/24	90°	24	24	Inside	Dimensional full corner drainboard
IFC-24/30L	90°	30	24	Inside	Dimensional full corner drainboard
IFC-24/30R	90°	24	30	Inside	Dimensional full corner drainboard
CA-LEG	N/A	N/A	N/A	N/A	Full side and leg set, 19" deep
CB-LEG	N/A	N/A	N/A	N/A	Full side and leg set, 24" deep



## Underbar Drainboard Glassracks and Cabinets

More details available. Please visit [www.glastender.com](http://www.glastender.com)

Drainboard glassracks have a stationary or roll-out bottom shelf, adjustable or roll-out intermediate shelf, and drainboard work surface. All models are 24" deep. The 24" wide models hold 20" x 20" racks, and the 18" wide models hold the 16" round rack used with the Glastender GT18 glasswasher (racks not included). Since drainboard and glassrack shelves are solid, they can be used for non-glassrack storage. If a 19" deep drainboard glassrack is required, order a 19" deep drainboard glassrack less doors.

Drainboard cabinets are similar to glassracks, although the intermediate shelf is adjustable and available with or without doors. Models with doors come with a lock. The 12", 18" and 24" wide cabinets have one door, all others have two. Drainboard cabinets are also available with a flat stainless steel filler board in lieu of the drainboard top (substitute an "F" for the "D" in the model number), and made to order thus not returnable. Drainboard half cabinets are on 16" legs allowing cleaning underneath, and come with or without doors.



DBGR-24-RS



DBGR-24



DBCB-18



DBHA-18-LD

Part #	Length"	Depth"	Description
DBGR-18	18	24	Drainboard glassrack
DBGR-24	24	24	Drainboard glassrack
DBGR-24-RS	24	24	Drainboard glassrack
DBCA-12*	12	19	Drainboard cabinet, 1 door
DBCA-18*	18	19	Drainboard cabinet, 1 door
DBCA-24*	24	19	Drainboard cabinet, 1 door
DBCA-30*	30	19	Drainboard cabinet, 2 doors
DBCA-36*	36	19	Drainboard cabinet, 2 doors
DBCA-42*	42	19	Drainboard cabinet, 2 doors
DBCA-48*	48	19	Drainboard cabinet, 2 doors
DBCB-12	12	24	Drainboard cabinet, 1 door
DBCB-18	18	24	Drainboard cabinet, 1 door
DBCB-24	24	24	Drainboard cabinet, 1 door
DBCB-30	30	24	Drainboard cabinet, 2 doors
DBCB-36	36	24	Drainboard cabinet, 2 doors
DBCB-42	42	24	Drainboard cabinet, 2 doors
DBCB-48	48	24	Drainboard cabinet, 2 doors
DBCA-12-LD*	12	19	Drainboard cabinet
DBCA-18-LD*	18	19	Drainboard cabinet
DBCA-24-LD*	24	19	Drainboard cabinet
DBCA-30-LD*	30	19	Drainboard cabinet
DBCA-36-LD*	36	19	Drainboard cabinet
DBCA-42-LD*	42	19	Drainboard cabinet
DBCA-48-LD*	48	19	Drainboard cabinet
DBCB-12-LD	12	24	Drainboard cabinet
DBCB-18-LD	18	24	Drainboard cabinet
DBCB-24-LD	24	24	Drainboard cabinet
DBCB-30-LD	30	24	Drainboard cabinet
DBCB-36-LD	36	24	Drainboard cabinet
DBCB-42-LD	42	24	Drainboard cabinet
DBCB-48-LD	48	24	Drainboard cabinet
DBHA-12*	12	19	Drainboard 1/2 cabinet, 1 door
DBHA-18*	18	19	Drainboard 1/2 cabinet, 1 door
DBHA-24*	24	19	Drainboard 1/2 cabinet, 1 door
DBHA-12-LD*	12	19	Drainboard 1/2 cabinet
DBHA-18-LD*	18	19	Drainboard 1/2 cabinet
DBHA-24-LD*	24	19	Drainboard 1/2 cabinet
DBHB-12*	12	24	Drainboard 1/2 cabinet, 1 door
DBHB-18*	18	24	Drainboard 1/2 cabinet, 1 door
DBHB-24*	24	24	Drainboard 1/2 cabinet, 1 door
DBHB-12-LD*	12	24	Drainboard 1/2 cabinet
DBHB-18-LD*	18	24	Drainboard 1/2 cabinet
DBHB-24-LD*	24	24	Drainboard 1/2 cabinet

\*Made to order and not returnable.

## Underbar Glassracks, Drainboard Drawer Units, POS Cabinets, Add-On Cabinet Bases

More details available. Please visit [www.glastender.com](http://www.glastender.com)

Glassracks are designed to hold three racks of glassware; one on the bottom shelf and one on each of the two adjustable glass rack slides. The 24" wide models hold 20" x 20" racks (not included), and the 18" wide models hold the 16" round racks (not included) with the Glastender GT18 glasswasher.

Drainboard drawer units have a removable locking drawer and drainboard surface. This allows for more storage space without sacrificing the ability to have a speed rail. Special speed rails (listed below) are required with drawer units. 19" drainboard drawer units are made to order and not returnable.

The add-on cabinet base is installed beneath standard underbar equipment to provide additional storage and enhance the look of the bar by eliminating storage of loose items under the bar and makes plumbing less visible. The back of the cabinet provides access to plumbing. The removable stainless steel floor has radius corners for easy cleaning, and interior walls are dual panel for a smooth interior and cleaning ease.

POS cabinets have a 26" high work surface to accommodate a cash drawer and POS monitor. Left and right side splashes are standard, as well as a louvered door to ventilate the storage cabinet. The work surface has a grommeted cord access hole.



Part #	Length"	Depth"	Description
GRA-18	18	19	Glassrack
GRA-24	24	19	Glassrack
GRB-18	18	24	Glassrack
GRB-24	24	24	Glassrack
DBDA-18*	18	19	Drainboard drawer unit
DBDA-24*	24	19	Drainboard drawer unit
DBDA-30*	30	19	Drainboard drawer unit
DBDB-18*	18	24	Drainboard drawer unit
DBDB-24*	24	24	Drainboard drawer unit
DBDB-30*	30	24	Drainboard drawer unit
ACB-12*	12	24	Add-on cabinet base, 1 door
ACB-14*	14	24	Add-on cabinet base, 1 door
ACB-18*	18	24	Add-on cabinet base, 1 door
ACB-24*	24	24	Add-on cabinet base, 2 doors
ACB-30*	30	24	Add-on cabinet base, 2 doors
ACB-36*	36	24	Add-on cabinet base, 2 doors
ACB-42*	42	24	Add-on cabinet base, 2 doors
ACB-48*	48	24	Add-on cabinet base, 2 doors
PCB-18	18	24	Point of sale (POS) cabinet
PCB-24	24	24	Point of sale (POS) cabinet
SSR-18-D	N/A	18 long	Speed rail, drainboard drawer
SSR-24-D	N/A	24 long	Speed rail, drainboard drawer
SSR-30-D	N/A	30 long	Speed rail, drainboard drawer

\*Made to order and not returnable.

## Underbar Single Bowl Sinks

More details available. Please visit [www.glastender.com](http://www.glastender.com)

Single bowl sinks are available as hand sinks and wet waste sinks. Wet sinks include a lift-out perforated plastic strainer. All sinks come with a mounted hot and cold gooseneck faucet.

Hand sink models HSA12D, HSB12D and HSB12AD include a soap dispenser (refill from above) front-skirt-mounted and C-fold paper towel dispenser. Models DHSA18, DHSB12 and DHSB18 include a soap dispenser and hinged front-access door to conceal C-fold paper towel dispenser, which are easily accessed below the door. (The access door is only opened for re-loading the paper towel dispenser.)

Specialty Wet Waste Sinks:

Model SWB12C has a cabinet base with storage space for three 1-gallon chemical containers. Model SWB18DW has a cabinet base with work surface trash chute hole and front hinged access door (stainless steel trash container, model DWC, is available as an accessory). Model SWB18DB has a drainboard work surface with recessed wet waste sink below. Models SWB24LC and SWB24RC (L or R in the model number designates the sink location) include a 12" drain board section in the work surface and an open front cabinet base with center vertical divider.



Part #	Length"	Depth"	Description
HSA-12	12	19	Hand sink
HSA-18	18	19	Hand sink
HSA-12-D	12	19	Hand sink, soap & towel disp.
DHSA-18	18	19	Hand sink
HSB-12	12	24	Hand sink
HSB-18	18	24	Hand sink
HSB-12-D	12	24	Hand sink, soap & towel disp.
HSB-12-AD	12	24	Hand sink, soap & towel disp.
DHSB-12	12	24	Hand sink, soap & towel disp.
DHSB-18	18	24	Hand sink, soap & towel disp.
SWA-12	12	19	Wet waste sink
SWA-18	18	19	Wet waste sink
SWB-12	12	24	Wet waste sink
SWB-18	18	24	Wet waste sink
SWB-12-C	12	24	Wet waste sink, cabinet base
SWB-18-DW	18	24	Wet waste sink, cabinet, chute
SWB-18-DB	18	24	Wet waste sink, cabinet w door, drainboard
SWB-24L-C	24	24	Wet waste sink, cabinet, (or R-C)
DI-HS12	12	17	Drop-in sink
DI-HS14	14	15	Drop-in sink

Part #	Description
SSR-12	12" single speed rail
SSR-18	18" single speed rail
DSR-12	12" double speed rail
DSR-18	18" double speed rail
03000483	Wet waste sink strainer
TR	Towel ring
DWR-12	Dry waste rail
DWC	Dry waste container, stainless steel
LSA-D	19" deep left end splash
RSA-D	19" deep right end splash
LSB-D	24" deep left end splash
RSB-D	24" deep right end splash
TD-C	Paper towel dispenser, C-fold
03001873	Liquid soap dispenser, hand pump
03000511	Wrist handles, set of two
03000512	P-trap for sinks, 17 ga. chrome plated steel

Speed rails and dry waste rails cannot be mounted to models:  
HSA12D, DHSA18, HSB12D, HSB12AD, DHSB12, DHSB18,  
SWB12C, SWB18DW, SWB18DB, SWB24LC, SWB24RC

TDC paper towel dispenser cannot be mounted to models:  
SWB12C, SWB18DW, SWB18DB, SWB24LC, SWB24RC

## Underbar Multiple Bowl Sinks

Multiple sinks come in three different styles: two, three and four compartment. They feature an exclusive one-piece 18 gauge stainless steel top that is seamless from the front rail all the way through the backsplash.

Each style is available with or without built-in drainboards on one or both sides of the sink compartments. Drainboards, where included, are a seamless and integral part of the work surface and have a lift-out perforated insert. The seamless weld bowls are 16 gauge fabricated stainless steel. An "L" or "R" designates the location of the sink compartment as left or right when there is only one drainboard.

All sinks include one overflow tube per bowl. 19" deep models have a backsplash mounted faucet. Perforated stainless steel inserts are available to cover sinks when not in use.



Part #	Description
SSR-24	24" single speed rail
SSR-36	36" single speed rail
SSR-48	48" single speed rail
SSR-60	60" single speed rail
SSR-66	66" single speed rail
SSR-72	72" single speed rail
SSR-84	84" single speed rail
DSR-24	24" double speed rail
DSR-36	36" double speed rail
DSR-48	48" double speed rail
DSR-60	60" double speed rail
DSR-66	66" double speed rail
DSR-72	72" double speed rail
DSR-84	84" double speed rail
TR	Towel ring
LWS	Large wet waste strainer
DWR-12	Dry waste rail
03002552	Sink cover, perforated, DSA or DSB
03002553	Sink cover, perforated, TSA or TSB
03002554	Sink cover, perforated, FSA or FSB
03000512	P-trap for sinks, 17 ga. chrome plated steel

Part Number	Number Sinks	Overall Length"	Depth"	Sink Location	Drain-Board"
DSA-24-S*	2	24	19	Center	N/A
DSA-36L-S*	2	36	19	Left	12
DSA-36R-S*	2	36	19	Right	12
DSA-48-S*	2	48	19	Center	2@12
DSB-24-S*	2	24	24	Center	N/A
DSB-36L-S*	2	36	24	Left	12
DSB-36R-S*	2	36	24	Right	12
DSB-48-S*	2	48	24	Center	2@12
TSA-36-S	3	36	19	Center	N/A
TSA-48L-S*	3	48	19	Left	12
TSA-48R-S*	3	48	19	Right	12
TSA-60-S	3	60	19	Center	2@12
TSA-60L-S*	3	60	19	Left	24
TSA-60R-S*	3	60	19	Right	24
TSA-66L-S*	3	66	19	Left	30
TSA-66R-S*	3	66	19	Right	30
TSA-72-S	3	72	19	Center	2@18
TSA-84-S*	3	84	19	Center	2@24
TSA-96-S*	3	96	19	Center	2@30
TSB-36-S	3	36	24	Center	N/A
TSB-48L-S*	3	48	24	Left	12
TSB-48R-S*	3	48	24	Right	12
TSB-60-S	3	60	24	Center	2@12
TSB-60L-S*	3	60	24	Left	24
TSB-60R-S*	3	60	24	Right	24
TSB-66L-S*	3	66	24	Left	30
TSB-66R-S*	3	66	24	Right	30
TSB-72-S	3	72	24	Center	2@18
TSB-84-S*	3	84	24	Center	2@24
TSB-96-S*	3	96	24	Center	2@30
FSA-48-S	4	48	19	Center	N/A
FSA-60L-S*	4	60	19	Left	12
FSA-60R-S*	4	60	19	Right	12
FSA-66L-S*	4	66	19	Left	18
FSA-66R-S*	4	66	19	Right	18
FSA-72-S	4	72	19	Center	2@12
FSA-72L-S*	4	72	19	Left	24
FSA-72R-S*	4	72	19	Right	24
FSA-84-S*	4	84	19	Center	2@18
FSA-96-S*	4	96	19	Center	2@24
FSB-48-S	4	48	19	Center	N/A
FSB-60L-S*	4	60	19	Left	12
FSB-60R-S*	4	60	19	Right	12
FSB-66L-S*	4	66	19	Left	18
FSB-66R-S*	4	66	19	Right	18
FSB-72-S	4	72	19	Center	2@12
FSB-72L-S*	4	72	19	Left	24
FSB-72R-S*	4	72	19	Right	24
FSB-84-S*	4	84	19	Center	2@18
FSB-96-S*	4	96	19	Center	2@24

\*Made to order and not returnable.

## Underbar Beer Drainers and Liquor Displays

More details available. Please visit [www.glastender.com](http://www.glastender.com)

Beer drainers have a 26" high, lowered work surface designed for use with an undercounter beverage dispenser. The work surface includes a drain pan with perforated insert to serve as the drip pan for the dispenser with a tubing chase notched rear deck for beverage line installation and access.

Liquor displays provide tiered liquor bottle storage at a convenient height for bartenders. Each step and rail has sound deadening

covers, and each rail includes a clear lift-off liquor identification cover, and radius interior corners for easy cleaning. The 24" deep models provide four tiers, and 29" deep models provide five. Liquor displays cannot have a speed rail mounted to them but align with underbar with a speed rail, and appearance matches a speed rail for continuity. Locking speed rail covers can be used on each row.

Slanted liquor displays are used with 20" x 20" racks. Cabinet model has a locking door and 2" casters.



Beer drainer



LDA-18S



SLD-24



SLDC-24

Part #	Length"	Depth"	Description
BDA-18*	18	19	Beer drainer
BDA-24*	24	19	Beer drainer
BDA-30*	30	19	Beer drainer
BDA-36*	36	19	Beer drainer
BDB-18*	18	24	Beer drainer
BDB-24*	24	24	Beer drainer
BDB-30*	30	24	Beer drainer
BDB-36*	36	24	Beer drainer
LDA-12S	12	24	Liquor display, aligns w 19" UB w speed rail
LDA-18S	18	24	Liquor display, aligns w 19" UB w speed rail
LDA-24S	24	24	Liquor display, aligns w 19" UB w speed rail
LDA-30S*	30	24	Liquor display, aligns w 19" UB w speed rail
LDA-36S*	36	24	Liquor display, aligns w 19" UB w speed rail
LDA-42S*	42	24	Liquor display, aligns w 19" UB w speed rail
LDB-12	12	24	Liquor display, aligns w 24" UB w/o speed rail
LDB-18	18	24	Liquor display, aligns w 24" UB w/o speed rail
LDB-24	24	24	Liquor display, aligns w 24" UB w/o speed rail
LDB-30*	30	24	Liquor display, aligns w 24" UB w/o speed rail
LDB-36*	36	24	Liquor display, aligns w 24" UB w/o speed rail
LDB-42*	42	24	Liquor display, aligns w 24" UB w/o speed rail
LDA-12D	12	29	Liquor display, aligns w 19" UB w dbl speed rail
LDA-18D	18	29	Liquor display, aligns w 19" UB w dbl speed rail
LDA-24D	24	29	Liquor display, aligns w 19" UB w dbl speed rail
LDA-30D*	30	29	Liquor display, aligns w 19" UB w dbl speed rail
LDA-36D*	36	29	Liquor display, aligns w 19" UB w dbl speed rail
LDA-42D*	42	29	Liquor display, aligns w 19" UB w dbl speed rail
LDB-12S	12	29	Liquor display, aligns w 24" UB w sngl speed rail
LDB-18S	18	29	Liquor display, aligns w 24" UB w sngl speed rail
LDB-24S	24	29	Liquor display, aligns w 24" UB w sngl speed rail
LDB-30S*	30	29	Liquor display, aligns w 24" UB w sngl speed rail
LDB-36S*	36	29	Liquor display, aligns w 24" UB w sngl speed rail
LDB-42S*	42	29	Liquor display, aligns w 24" UB w sngl speed rail
SLD-24*	24	24	Slanted liquor display
SLDC-24*	24	24	Slanted liquor display with cabinet

\*Made to order and not returnable.

## Underbar Dry Waste and Wait Stations

More details available. Please visit [www.glastender.com](http://www.glastender.com)

The top lifts up on all dry waste chutes to empty the trash receptacle, and lifts off for cleaning. DWB12 mounts between two adjacent pieces of underbar. DWB15L and DWB15R include a left or right side and leg set, and mount to one side of the underbar. DWB18 is freestanding. All models are designed to house a Rubbermaid® Slim Jim™ trash receptacle.

Dry waste rail looks like a speed rail but is a chute for a 16"H (or less) trash receptacle. Dry waste rails cannot be used on cabinets, glassracks or ice cream freezers. Ice cream freezers are fully insulated, have dipper well and faucet, 6' grounded cord and plug, and 5 year compressor warranty. 24" unit holds one 3 gallon container of ice cream, 36" holds two.

Wait stations mount to the server side of the bar die for convenient storage of common server items. Cabinet includes menu holder, welded bowl with removable plastic wash basin, intermediate shelf, and special compartment for vertical 14" or 16" round server tray storage with a hole in the bottom to prevent trays from rolling out. No plumbing required. Includes wall mounting brackets.



DWB-15L



DWB-18



WS24



DWR-12



WS36-S with WPH

Part #	Length"	Depth"	Description
DWB-12	12	24	Dry waste chute
DWB-15L	15	24	Dry waste chute, L side & legs
DWB-15R	15	24	Dry waste chute, R side & legs
DWB-18*	18	24	Dry waste chute, freestanding
DWR-12	12	5	Dry waste rail
WS24	24	15	Wait station
WS36	36	15	Wait station
WS36-S	36	15	Wait station, SS bowl, removable plastic washrag basin

Part #	Description
DWC	SS dry waste container
03000497	Slim Jim plastic trash receptacle
SSR-24	Single speed rail for ice cream freezer
SSR-36	Single speed rail for ice cream freezer
DSR-24	Double speed rail for ice cream freezer
DSR-36	Double speed rail for ice cream freezer
WPH	Wall-mounted pan holder
WPH-LP	Wall-mounted pan holder, less pan
MH-L	Menu holder, mounts left
MH-R	Menu holder, mounts right
03003317	1/4th pan, SS, 6" deep
03003318	1/4th pan, plastic, 6" deep
03003294	Plastic washrag basin

\*Made to order and not returnable.

## Underbar All-In-One Stations

All-in-one stations combine different underbar components into one pre-assembled unit, and can be ordered with or without a cold plate. Stations are 29" deep. Sinks include goose neck faucet. All-in-one stations are made to order and are not returnable.

More details available. Please visit [www.glastender.com](http://www.glastender.com)



\*Made to order and not returnable.

Part Number w/o Cold Plate	Part Number with 10 Circuit Cold Plate	Width"	36" Combo Ice Bin	42" Combo Ice Bin	12" Single Wet Waste Sink	12" Single Wet Waste Sink, L Splash	12" Blender Shelf with Towel Ring	12" Liquor Display	18" Liquor Display	36" Double Speed Rail	42" Double Speed Rail	12" Dry Waste Rail	12" Recessed Drainboard	18" Recessed Drainboard	Condiment Dispenser
ALL-60A*	ALL-60A-CP10*	60	X		X	X	X			X		X			X
ALL-60B*	ALL-60B-CP10*	60	X		X	X				X		X	X		X
ALL-66A*	ALL-66A-CP10*	66		X	X	X	X				X	X			X
ALL-66B*	ALL-66B-CP10*	66		X	X	X					X	X	X		X
ALL-66C*	ALL-66C-CP10*	66	X		X	X				X		X		X	X
ALL-66D*	ALL-66D-CP10*	66	X		X	X		X	X	X		X			X
ALL-72*	ALL-72-CP10*	72	X		X	X	X			X		X	X		X
ALL-72A*	ALL-72A-CP10*	72		X	X	X		X			X	X			X
ALL-72B*	ALL-72B-CP10*	72		X	X	X					X	X		X	X

## Underbar Speed Rails

Standard features include:

- All stainless steel construction
- Open channel-and-rail design for easy cleaning and better view of bottles
- ABS sound deadening covers
- Locking covers for Single Speed Rails include built-in storage hangers when ordered with original equipment
- Each rail includes a clear lift-off liquor-identification cover
- Radius corners for easy cleaning



Part #	Size"	Description
SSR-12	12	Single speed rail
SSR-13T018	13 - 18	Single speed rail
SSR-18	18	Single speed rail
SSR-19T024	19 - 24	Single speed rail
SSR-24	24	Single speed rail
SSR-25T030	25 - 30	Single speed rail
SSR-30	30	Single speed rail
SSR-31T036	31 - 36	Single speed rail
SSR-36	36	Single speed rail
SSR-37T042	37 - 42	Single speed rail
SSR-42	42	Single speed rail
SSR-43T048	43 - 48	Single speed rail
SSR-48	48	Single speed rail
SSR-49T054	49 - 54	Single speed rail
SSR-54	54	Single speed rail
SSR-55T060	55 - 60	Single speed rail
SSR-60	60	Single speed rail
SSR-61T066	61 - 66	Single speed rail
SSR-66	66	Single speed rail
SSR-67T072	67 - 72	Single speed rail
SSR-72	72	Single speed rail
SSR-73T078	73 - 78	Single speed rail
SSR-79T084	79 - 84	Single speed rail
SSR-84	84	Single speed rail
SSRC-12	12	Single speed rail locking cover
SSRC-13T018	13 - 18	Single speed rail locking cover
SSRC-19T024	19 - 24	Single speed rail locking cover
SSRC-25T030	25 - 30	Single speed rail locking cover
SSRC-31T036	31 - 36	Single speed rail locking cover
SSRC-37T042	37 - 42	Single speed rail locking cover
SSRC-43T048	43 - 48	Single speed rail locking cover
SSRC-X	X	Single speed rail cover, replace X with length
CSR-12-SR	12	Clip-on single speed rail to existing single
CSR-18-SR	18	Clip-on single speed rail to existing single
CSR-24-SR	24	Clip-on single speed rail to existing single
CSR-30-SR	30	Clip-on single speed rail to existing single
CSR-36-SR	36	Clip-on single speed rail to existing single
CSR-42-SR	42	Clip-on single speed rail to existing single
CSR-48-SR	48	Clip-on single speed rail to existing single

Part #	Size"	Description
DSR-12	12	Single speed rail
DSR-13T018	13 - 18	Single speed rail
DSR-18	18	Single speed rail
DSR-19T024	19 - 24	Single speed rail
DSR-24	24	Single speed rail
DSR-25T030	25 - 30	Single speed rail
DSR-30	30	Single speed rail
DSR-31T036	31 - 36	Single speed rail
DSR-36	36	Single speed rail
DSR-37T042	37 - 42	Single speed rail
DSR-42	42	Single speed rail
DSR-43T048	43 - 48	Single speed rail
DSR-48	48	Single speed rail
DSR-49T054	49 - 54	Single speed rail
DSR-54	54	Double speed rail
DSR-55T060	55 - 60	Double speed rail
DSR-60	60	Double speed rail
DSR-61T066	61 - 66	Double speed rail
DSR-66	66	Double speed rail
DSR-67T072	67 - 72	Double speed rail
DSR-72	72	Double speed rail
DSR-73T078	73 - 78	Double speed rail
DSR-79T084	79 - 84	Double speed rail
DSR-84	84	Double speed rail
DSRC-12	12	Double speed rail locking cover
DSRC-13T018	13 - 18	Double speed rail locking cover
DSRC-19T024	19 - 24	Double speed rail locking cover
DSRC-25T030	25 - 30	Double speed rail locking cover
DSRC-31T036	31 - 36	Double speed rail locking cover
DSRC-37T042	37 - 42	Double speed rail locking cover
DSRC-43T048	43 - 48	Double speed rail locking cover
DSRC-X	X	Double speed rail cover, replace X with length



## Underbar Drink Rails, Drain Pans and Kick Rails

More details available. Please visit [www.glastender.com](http://www.glastender.com)

Drink rails mount to the underside of the bar top and have a removable perforated insert. 30" and 36" models have one gusset, 42" and 48" rails have two gussets for added strength. 1/2" welded tailpiece drain exits from the back. Installation kit includes: 10' of clear vinyl drain tube, one 4" Ty-wrap, three #10 SS wood screws, three cable clamps and one 1/2" x 1/2" x 1/2" plastic tee.

Drop-in drain pans fit into the countertop and self rimming edges fit tightly to the work surface. Comes with the same installation kit as drink rail except there are two 1/2" elbows rather than one tee. Standard lengths are from 24" to 48". Custom sizes also available.

Drink rails and drop-in drain pans are made to order and not returnable.



Part #	Size"	Description
DR12R	12	Drink rail, right side drain
DR18R	18	Drink rail, right side drain
DR24R	24	Drink rail, right side drain
DR30R	30	Drink rail, right side drain
DR36R	36	Drink rail, right side drain
DR42R	42	Drink rail, right side drain
DR48R	48	Drink rail, right side drain
DR12L	12	Drink rail, left side drain
DR18L	18	Drink rail, left side drain
DR24L	24	Drink rail, left side drain
DR30L	30	Drink rail, left side drain
DR36L	36	Drink rail, left side drain
DR42L	42	Drink rail, left side drain
DR48L	48	Drink rail, left side drain
DRIC45	N/A	45° inside corner filler
DRIC90	N/A	90° inside corner filler
DROC45	N/A	45° outside corner filler
DROC90	N/A	90° outside corner filler
DIDP12X24	12 x 24	Drop-in drain pan
DIDP12X30	12 x 30	Drop-in drain pan
DIDP12X36	12 x 36	Drop-in drain pan
DIDP12X42	12 x 42	Drop-in drain pan
DIDP12X48	12 x 48	Drop-in drain pan
DI-DP18X24	18 x 24	Drop-in drain pan
DI-DP18X30	18 x 30	Drop-in drain pan
DI-DP18X36	18 x 36	Drop-in drain pan
DI-DP18X42	18 x 42	Drop-in drain pan
DI-DP18X48	18 x 48	Drop-in drain pan
CKR-18	18	Kick rail
CKR-24	24	Kick rail
CKR-30	30	Kick rail
CKR-36	36	Kick rail
CKR-42	42	Kick rail
CKR-48	48	Kick rail

**Underbar Modular Bar Die**

More details available. Please visit [www.glastender.com](http://www.glastender.com)

Underbar equipment is mounted to and supported on the bar die. All underbar equipment is pre-assembled and mounted to the bar die at the factory, then broken down into shippable sections. Installation of the bar die is simpler than a conventional millwork bar die and has many advantages...

**Benefits:**

- Stainless steel from floor to the bar top on bartender side
- Floor can be sealed to the bar die to prevent moisture from seeping from the bartender side to the customer side
- Galvanized steel will not rot
- Eliminates all underbar legs for easy cleaning
- Built-in chaseways for beer, soda, plumbing and electrical lines provide a cleaner, more attractive bar
- Can be used in conjunction with removable front millwork finishing panels to provide easy access to beer, soda, plumbing and electrical lines for future modification, maintenance or repair
- Pre-engineered to exact dimensions to ensure a precise fit
- Pre-assembly from the factory lowers installation costs
- Millwork bar top and front panels can be pre-fabricated and easily attached

The total number of feet required is calculated by determining the overall outside dimension of the bar die wall. Please round to the nearest whole foot.



Underbar with modular bar die

Part #	Description
MD	Modular bar die, priced per foot



Underbar without modular bar die

## Pass-Thru Cocktail Stations

Designed to eliminate wasted steps and save time, the pass-thru cocktail station allows the bartender and cocktail servers to work more efficiently, and able to serve more drinks per hour.

Front and end finish panels to match the existing decor are provided, which hold up the tray shelf and optional single or double overshelves. Laminated panels are available in stainless steel, or any standard laminate color (please specify the manufacturer, color and catalog number when ordering). If you prefer to make your own finish panels, Glastender's specification guide has the drawings and details necessary for fabrication.

More details available. Please visit [www.glastender.com](http://www.glastender.com)

Orientation determines the work flow, and is usually dictated by the position of the glasswasher. Counterclockwise: the work flow is right to left with the glasswasher on the left. Clockwise: the work flow is left to right with the glasswasher on the bartender's right.

\*Cocktail stations are made to order and not returnable.



72" cocktail station, server side



42" cocktail station, bartender side



42" cocktail station, server side

Part Number	Size"	Rotation	Pass-Thru Ice Bin	Tubing Chase	Wet Waste Sink, Gooseneck Faucet, Strainer	Blender Shelf	Double Speed Rail	12" Wide SS Draining Tray Shelf	15" Wide SS Draining Tray Shelf	8 Bottle Insulated Storage Well	Laminated Front and End Panels
<b>Assembly Style</b>											
CS-42X26-CW*	42 x 26	CW	X	X	X	X	X	X			X
CS-42X26-CCW*	42 x 26	CCW	X	X	X	X	X	X			X
CS-42X26-CW-S*	42 x 26	CW	X	X	X	X	X	X			
CS-42X26-CCW-S*	42 x 26	CCW	X	X	X	X	X	X			
CS-42X32-CW*	42 x 32	CW	X	X	2	X	X		X		X
CS-42X32-CCW*	42 x 32	CCW	X	X	2	X	X		X		X
CS-42X32-CW-S*	42 x 32	CW	X	X	2	X	X		X		
CS-42X32-CCW-S*	42 x 32	CCW	X	X	2	X	X		X		
CS-54X32-CW*	54 x 32	CW	X	X	2	X	X		X	X	X
CS-54X32-CCW*	54 x 32	CCW	X	X	2	X	X		X	X	X
CS-54X32-CW-S*	54 x 32	CW	X	X	2	X	X		X	X	
CS-54X32-CCW-S*	54 x 32	CCW	X	X	2	X	X		X	X	
CS-60X32-CW*	60 x 32	CW	2	X	2	X	X		X		X
CS-60X32-CCW*	60 x 32	CCW	2	X	2	X	X		X		X
CS-60X32-CW-S	60 x 32	CW	2	X	2	X	X		X		
CS-60X32-CCW-S	60 x 32	CCW	2	X	2	X	X		X		

## Pass-Thru Cocktail Stations

More details available. Please visit [www.glastender.com](http://www.glastender.com)



CS-72-CCW with optional  
SOS/SS-72 single overshelf



\*Cocktail stations are made to  
order and are not returnable.

Part Number	Size"	Rotation	GT24 Auto Conveyor Glasswasher	GT30 Auto Conveyor Glasswasher	Wet Waste Sink, Gooseneck Faucet, Strainer	SS Removable Dry Waste Receptacle	Pass-Thru Ice Bin	Tubing Chase	Blender Shelf	Double Speed Rail	12" Wide SS Draining Tray Shelf	15" Wide SS Draining Tray Shelf	8 Bottle Insulated Storage Well	Laminated Front and End Panels	
<b>Disassembly Style</b>															
CS-42X26G-CW*	42 x 26	CW	X		X						X			X	
CS-42X26G-CCW*	42 x 26	CCW	X		X						X			X	
CS-42X26G-CW-S*	42 x 26	CW	X		X						X				
CS-42X26G-CCW-S*	42 x 26	CCW	X		X						X				
CS-42X32G-CW*	42 x 32	CW	X		2	X					X			X	
CS-42X32G-CCW*	42 x 32	CCW	X		2	X					X			X	
CS-42X32G-CW-S*	42 x 32	CW	X		2	X					X				
CS-42X32G-CCW-S*	42 x 32	CCW	X		2	X					X				
CS-48X32G-CW*	48 x 32	CW		X	2							X		X	
CS-48X32G-CCW*	48 x 32	CCW		X	2							X		X	
CS-48X32G-CW-S*	48 x 32	CW		X	2							X			
CS-48X32G-CCW-S*	48 x 32	CCW		X	2							X			
<b>Complete Style</b>															
CS-66X26-CW*	66 x 26	CW	X		X		X	X	X	X	X	X		X	
CS-66X26-CCW*	66 x 26	CCW	X		X		X	X	X	X	X	X		X	
CS-66X26-CW-S*	66 x 26	CW	X		X		X	X	X	X	X	X			
CS-66X26-CCW-S*	66 x 26	CCW	X		X		X	X	X	X	X	X			
CS-66X32-CW*	66 x 32	CW	X		2	X	X	X	X	X	X	X		X	
CS-66X32-CCW*	66 x 32	CCW	X		2	X	X	X	X	X	X	X		X	
CS-66X32-CW-S*	66 x 32	CW	X		2	X	X	X	X	X	X	X			
CS-66X32-CCW-S*	66 x 32	CCW	X		2	X	X	X	X	X	X	X			
CS-72-CW*	72 x 32	CW		X	2		X	X	X	X	X	X		X	
CS-72-CCW*	72 x 32	CCW		X	2		X	X	X	X	X	X		X	
CS-72-CW-S*	72 x 32	CW		X	2		X	X	X	X	X	X			
CS-72-CCW-S*	72 x 32	CCW		X	2		X	X	X	X	X	X			
CS-84-CW*	84 x 32	CW		X	2		X	X	X	X	X	X	X	X	
CS-84-CCW*	84 x 32	CCW		X	2		X	X	X	X	X	X	X	X	
CS-84-CW-S	84 x 32	CW		X	2		X	X	X	X	X	X	X		
CS-84-CCW-S	84 x 32	CCW		X	2		X	X	X	X	X	X	X		

## Cocktail Station Accessories

“SS, not laminate panels” converts laminated front and end panels to stainless steel panels at the factory, and includes foamed-in-place insulation.

Cold plates are built-in to pass-thru ice bin liner at the factory.

Clip-on condiment dispenser clips to either side of station. Clip-on single and double speed rails clip to bartender side. Clip-on dry waste receptacle clips to server side.

Overshelves mount to the end panels, brackets included.

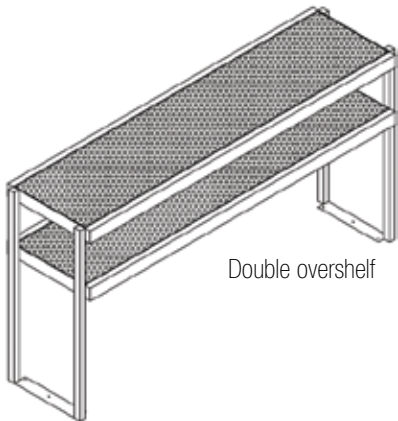

More details available. Please visit [www.glastender.com](http://www.glastender.com)

Part Number	Description	CS-42X26	CS-42X32	CS-54X32	CS-60X32	CS-42X26G	CS-42X32G	CS-48X32G	CS-66X26	CS-66X32	CS-72	CS-84
CPS-42X26	SS, not laminate panels	X				X						
CPS-42X32	SS, not laminate panels		X				X					
CPS-48X32	SS, not laminate panels							X				
CPS-54X32	SS, not laminate panels			X								
CPS-60X32	SS, not laminate panels				X							
CPS-66X26	SS, not laminate panels								X			
CPS-66X32	SS, not laminate panels									X		
CPS-72X32	SS, not laminate panels										X	
CPS-84X32	SS, not laminate panels											X
02000624	10 circuit cold plate	X				X			X			
02000626	10 circuit cold plate		X	X	X		X	X		X	X	X
SOS/SS-42	42" SS single overshelf	X	X			X	X					
SOS/SS-48	48" SS single overshelf							X				
SOS/SS-54	54" SS single overshelf			X								
SOS/SS-60	60" SS single overshelf				X							
SOS/SS-66	66" SS single overshelf								X	X		
SOS/SS-72	72" SS single overshelf										X	
SOS/SS-84	84" SS single overshelf											X
DOS/SS-42	42" SS double overshelf	X	X			X	X					
DOS/SS-48	48" SS double overshelf							X				
DOS/SS-54	54" SS double overshelf			X								
DOS/SS-60	60" SS double overshelf				X							
DOS/SS-66	66" SS double overshelf								X	X		
DOS/SS-72	72" SS double overshelf										X	
DOS/SS-84	84" SS double overshelf											X
IBD-H-CS26	26"D ice bin divider, half	X				X			X			
IBD-H-CS32	32"D ice bin divider, half		X	X	X		X	X		X	X	X
CCD/T	Condiment disp, clip-on	X	X	X	X	X	X	X	X	X	X	X
03000508	26"D sneeze guard	X				X			X			
03000509	32"D sneeze guard		X	X	X		X	X		X	X	X
SSR-16	16" single speed rail					X	X	X				
CSR-16	16" clipon singl speedrail					X	X		X	X		
CSR-22	22" clipon singl speedrail							X			X	X
DSR-16	16" double speed rail					X	X	X				
CDSR-16	16" clip-on dbl speed rail					X	X		X	X		
CDSR-22	22" clip-on dbl speed rail							X			X	X
CDRY	SS clip-on dry waste	X	X	X	X	X	X	X	X	X	X	X
BBS-16	16" bolt-on blender shelf					X	X	X				
UMRF	Undercounter mount rinsers											

## Cocktail Station Accessories

More details available. Please visit [www.glastender.com](http://www.glastender.com)

Part #	Description
EP-24	Laminated panel, 26" deep station end panel
EP-30	Laminated panel, 32" deep station end panel
FP-26	Laminated panel, 54" station front panel (2 required)
FP-29	Laminated panel, 60" station front panel (2 required)
FP-32	Laminated panel, 66" station front panel (2 required)
FP-35	Laminated panel, 72" station front panel (2 required)
FP-40	Laminated panel, 42" station front panel
FP-41	Laminated panel, 84" station front panel (2 required)
FP-46	Laminated panel, 48" station front panel
EP-24-SS	Stainless steel panel, 26" deep station end panel
EP-32-SS	Stainless steel panel, 32" deep station end panel
FP-26-SS	Stainless steel panel, 54" station front panel (2 required)
FP-29-SS	Stainless steel panel, 60" station front panel (2 required)
FP-32-SS	Stainless steel panel, 66" station front panel (2 required)
FP-35-SS	Stainless steel panel, 72" station front panel (2 required)
FP-40-SS	Stainless steel panel, 42" station front panel
FP-41-SS	Stainless steel panel, 84" station front panel (2 required)
FP-46-SS	Stainless steel panel, 48" station front panel
TSC__	12" wide tray shelf, sold in 12" lengths, __ specify length in inches
TSD__	15" wide tray shelf, sold in 12" lengths, __ specify length in inches
TS20X__	20" wide tray shelf, sold in 12" lengths, __ specify length in inches

Cocktail stations are made to order and not returnable.



## GW24 Rotary Glasswashers

New design features include a side notch space for three 1-gallon chemical containers (and optional slide-out rack), a drainboard top for glasses, a 75°F rinse providing clean glasses that are cool to the touch, and it uses less water than traditional rotary glasswashers!

2 minute 15 second cycle. Capacity: 41 glasses 2.75" diameter per cycle. Maximum glass height = 10". Minimum 120°F wash temp, and rinse temp adjustable down to 75°F. 120V/1/60Hz.

### Features:

- 30" work height to align with adjacent underbar for an attractive installation
- Sliding cover and cold water rinse prevent steam from escaping during and after the cycle
- Side notch provides space for three 1-gallon chemical containers within the 24" by 24" foot print
- Conveyor advance switch rotates conveyor one-half turn for easy glassware loading and unloading
- Covers and drainboard top are easily removable for cleaning
- Pumped wash and rinse ensures water line pressure variances do not affect wash results
- Pre-programmed de-liming cycle for easy removal of mineral deposits during maintenance (de-liming agent must be added)
- Conveyor and stationary spray box are easily removed for cleaning and visual inspection
- Removable side panels for easy service access
- Automatic peristaltic metering pumps accurately dispense detergent, sanitizer, and rinse aid
- Includes priming switches for easy chemical pump priming

More details available. Please visit [www.glastender.com](http://www.glastender.com)

The GWS66 includes a GW24 glasswasher with slide-out chemical bottle rack, SWB-18-DW wet waste sink cabinet with 03005491 trash receptacle, and DBGR-24-RS drainboard glassrack with roll-out shelves.

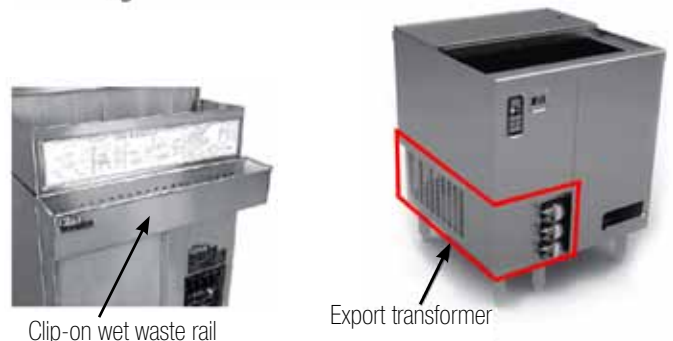

Part #	Description
GW24	Rotary glasswasher 24"L x 24"D
GWS66	Glasswasher station: GW24, SWB-18-DW, DBGR-24-RS
01001500	Slide-out chemical bottle rack for GW24
01001541	Export transformer converts to 220V/50 Hz (eliminates side notch)
CWET-GW	Clip-on wet waste for GW24
03005491	Trash receptacle, 28- 1/2 qt, gray plastic

## GT-24 and GT-30 Rotary Glasswashers

More details available. Please visit [www.glastender.com](http://www.glastender.com)

A rotary glasswasher is a mechanized three-compartment sink that washes, rinses, and sanitizes glassware up to 11" high automatically. During operation 5 GPM of hot soapy water (130°-150° F) is sprayed in a thorough spray pattern across the moving glassware removing lipstick, dried-on fruit pulp and cream. The wash water is recirculated to conserve water and detergent, consuming only 1/4 GPM of hot water during operation. 3 minute cycle: 60 seconds wash and rinse.

### Features:

- 90 day labor warranty
- Removable top, front and conveyor for easy cleaning
- Set of 3 curtains included
- Switch panel can be relocated in the field
- Removable side panels for easy service
- Automatic peristaltic metering pumps accurately dispense detergent, sanitizer, and rinse aid
- Heater is encased in sheath to resist caustic detergents
- Digital temperature gauge built into switch panel
- Thermostat controlled wash tank
- Sensor activated low water cut off protects heater
- Sensor alerts operator when detergent or sanitizer are low

GT-24 washes up to 13 glasses per minute (800 per hour), and GT-30 washes 21 glasses per minute (1,260 per hour).

2 GPM of 75° F fresh rinse water with sanitizer is pumped in the rinse tank in a thorough spray pattern across the moving glassware. Cool rinse water means no waiting for a glass to cool. The rotary conveyor automatically stops when the clean glass touches the glass stop arm. Removing the glass starts the conveyor. Or, if extremely busy, the glass stop arm can be put aside so starting and stopping is controlled by the conveyor switch.

Rotation selection is based on work flow. If a side mounted switch panel is required, it must be specified when ordering. Please refer to spec sheets for details.

Part #	Length"	Depth"	Rotation	Volts
GT-24-CW-208	24	24	Clockwise	208V
GT-24-CW-240	24	24	Clockwise	240V
GT-24-CCW-208	24	24	Counterclockwise	208V
GT-24-CCW-240	24	24	Counterclockwise	240V
GT-30-CW-208	30	30	Clockwise	208V
GT-30-CW-240	30	30	Clockwise	240V
GT-30-CCW-208	30	30	Counterclockwise	208V
GT-30-CCW-240	30	30	Counterclockwise	240V



Part #	Description
01000557	Export transformer, converts to 220V, 1 phase, 50 Hz
01000828	Mixing valve, mixes hot and cold water to 75° F
CWET-24	Clip-on wet waste for GT-24
CWET-30	Clip-on wet waste for GT-30
01000534	Stemware rack for GT-24
01000535	Stemware rack for GT-30



## GT-18 Rotary Glasswashers

More details available. Please visit [www.glastender.com](http://www.glastender.com)

There are 10 different GT18 models to select from to optimize your glasswasher throughput. 10 glasses per minute (600 per hour) capacity. Maximum glass height is 10", including pitchers and wine carafes.

### Features:

- 90 day labor warranty
- Drive wheel and glass rack lift out for easy cleaning
- Two 16" diameter polypropylene racks are included
- 15 spray nozzles for maximum soil removal
- Automatic peristaltic metering pumps accurately dispense detergent, sanitizer, and rinse aid
- Digital temperature gauge built into switch panel
- Intelligent microprocessor control delays cycle start if incoming water is below 120° F
- Prime switch for quick chemical priming
- Recirculation pump for wash and rinse water
- 2 minute cycle, 70 second wash and 22 second rinse

Extended GT18+2 models have the drain table extended on one side of the glasswasher to hold more than one rack. This increases overall glasswasher throughput by allowing multiple racks of glassware to be pre-loaded for washing.

78" models come with three racks, and 90" models come with four. A leg set is included under the extended drain table.

Part #	Description
01000532	Glass rack
01000533	Dish rack
01000536	Glass rack insert for stemware
01000710	Clip-on chemical rail
01000706	Glass rack holder for GT18+1 only
01000708	Glass rack holder for GT18+2, +1L or 1R models
01000709	Glass rack holder w shelf, GT18+2, +1L or 1R models
01000557	Export transformer, converts to 220V, 1 phase, 50 Hz



GT-18+2 with SWA-12 wet waste sink and 01000709 glass rack holder

Part #	Description	Length"	Drain Table
GT-18	Front load door type	18	N/A
GT-18+1	Front-to-back pass thru	18	Back
GT-18+1L	Front-to-side pass thru	36	Left
GT-18+1R	Front-to-side pass thru	36	Right
GT-18+2	Side-to-side pass thru	60	Left & right
GT-18+2-IC*	Side-to-side corner pass thru	42 x 42	Left & right
GT-18+2-78L*	Side-to-side pass thru, left extended	78	Left & right
GT-18+2-78R*	Side-to-side pass thru, right extended	78	Left & right
GT-18+2-90L*	Side-to-side pass thru, left extended	90	Left & right
GT-18+2-90R*	Side-to-side pass thru, right extended	90	Left & right

\*Made to order and not returnable.

## Bottle Disintegration System

The Bottle Disintegration System reduces the volume of glass bottle waste by as much as 85%, lowering your disposal fees and paying for itself over time. The BDS unit is easy to use and crushes a bottle in mere seconds, while being no louder than a standard blender.

### Features:

- Disintegrates beer, wine, and liquor bottles up to 4" in diameter and 14" in height
- The 4-gallon bucket holds approximately 43 lbs when full and is accessible for emptying by opening the front door (two buckets included)
- Compact design fits easily under the bar or in a service station
- Stainless steel interior and exterior resists corrosion and is easy to keep clean
- Includes safety interlock switches to ensure safe operation
- Bucket stop bar ensures bucket is fully seated when door is closed, bucket seating safety sensor prevents operation when the bucket is not in place
- The unit shuts down and a red indicator light is illuminated if the front access door is open or the bucket is not in place
- Multi-level baffle system on feed chute and gasket seal to maximize glass containment
- Green indicator light identifies when unit is running
- Easy operation - simply turn it on and push a bottle down the feed chute
- Includes locking casters so unit can be easily moved for cleaning



Part #	Description
BDS	Bottle disintegration system
CE-BDS	Convert to 220V/50Hz or 220V/60Hz electrical, *upgrade, not sold separately
14000053	Bucket for bottle disintegration system, 4 gallon



## Mug Frosters

Reach-in mug froster allows diverse glass storage and easy rotation of inventory while matching the look of the back bar coolers. Choose from black vinyl-clad, stainless front and sides, or all stainless. Matching backsplashes are available for a complete, consistent underbar design. All models have stainless steel top, sliding doors and interior, including evaporator housing and evaporator pan. 24" and 36" models have one door, 48" have two doors. Bottom rack is included on all models.

More details available. Please visit [www.glastender.com](http://www.glastender.com)

There are two defrost cycles: *automatic* occurs every six hours without affecting normal operation, *manual* is user selected six hour defrost with automatic restart.

Integrated toe kick and curb base mounts flat on all sides to seal to the floor. Condensate drains to an automatic evaporator so no drain connection is required. Condensing unit pulls out, and evaporator housing unplugs and lifts out for easy service. 5 year compressor warranty.

Capacity (based on 10 oz. mugs and 2 layers of shelves):  
24" = 105, 36" = 175, 48" = 252.



24" wide



48" wide



36" wide

Part #	Description
C-4X4	4 casters, 3-3/4"
MFLS	4 legs, 6"
MFKR-24	24" kick rail
MFKR-36	36" kick rail
MFKR-48	48" kick rail
SSR-24	24" single speed rail
SSR-36	36" single speed rail
SSR-48	48" single speed rail
MFBS-24	24" backsplash
MFBS-36	36" backsplash
MFBS-48	48" backsplash
CE-220/50S	Convert self contained unit to 220V/50Hz electrical

Dimensions"	Black Vinyl-Clad	Stainless Front & Sides	All Stainless	# of Shelves
24W x 24D x 34.5H	MF24-B	MF24-SF	MF24-S	0
24W x 24D x 34.5H	MF24-B1	MF24-SF1	MF24-S1	1
24W x 24D x 34.5H	MF24-B2	MF24-SF2	MF24-S2	2
36W x 24D x 34.5H	MF36-B	MF36-SF	MF36-S	0
36W x 24D x 34.5H	MF36-B1	MF36-SF1	MF36-S1	1
36W x 24D x 34.5H	MF36-B2	MF36-SF2	MF36-S2	2
48W x 24D x 34.5H	MF48-B	MF48-SF	MF48-S	0
48W x 24D x 34.5H	MF48-B1	MF48-SF1	MF48-S1	1
48W x 24D x 34.5H	MF48-B2	MF48-SF2	MF48-S2	2

## Back Bar Refrigeration

More details available. Please visit [www.glastender.com](http://www.glastender.com)

Glastender back bar coolers are available with up to four doors, and as self-contained or remote refrigerated. Coolers have black vinyl-clad steel exterior front and sides, and 180° swinging door. Nine door styles are available to satisfy diverse needs and decor. Edge cap on the laminated doors and compressor compartment covers protect laminate from chipping. Coolers are available without a finished top for integrated installation below a customer supplied bar top. 2008 Energy Star approved (except glass door units).

Unique end wall refrigeration design with evaporator located above the compressor compartment frees up interior space for maximum storage capacity. Recessed compressor compartment back and 90° electrical plug enables flush wall placement. Easy to remove condenser filter can be regularly cleaned to maintain condenser coil efficiency. Automatic and manual defrost cycles prevent ice build-up from impacting operation.

Leg sockets are recessed into the base, and 1/2" thick plastic threshold scuff plate protects lower door sill. Optional leg sets employ a unique recessed cup design to enhance durability. 16 gauge galvanized steel interlocking multi-bend base provides incredible strength and rigidity.

The all stainless steel interior with radius corners is easy to keep clean and meets NSF Standard 7 for open food containers on BB and ND models. Adjustable shelves have radius corners.

Glass ice displays and lighted liquor displays add functionality as well as visual appeal to the back bar. When mounted on a cooler at the factory, the 16" glass display units (GDU) have a rear deck that raises the lighted liquor display (LLD) above the back of the GDU, and the LLD has a front light channel to help illuminate the GDU (shown below).

The following units are made to order and not returnable: remote narrow door coolers, self-contained and remote low profile coolers, self-contained and remote pass-thru coolers, and front venting coolers.

Model	Long Neck Bottles, Cases	Wine Bottles, 750 ml
BB24	4.6	56
BB36	7	66
BB48	13.83	120
BB60	14	138
BB72	22.5	198
BB84	21.9	216
BB96	30.25	276
BB108	29.8	294
ND40	10.8	102
ND52	12.3	120
ND60	16.9	174
ND72	18.4	192
ND80	22.3	246
ND92	24.5	264



**Self-Contained Back Bar Coolers**

More details available. Please visit [www.glastender.com](http://www.glastender.com)



BB24-N1GSN(L)

One door self-contained back bar cooler. Available in remote version.

**Create a model number by selecting from the options below:**

**BB24N** - - - - - **( )**

- Base Height:**  
1 = 1"  
6 = 6" legs
- Door Style:**  
B = Black vinyl-clad  
U = Unlaminated  
L = Laminated  
S = Stainless  
G = Glass  
X = Stainless glass  
Y = Laminated glass
- Top Style:**  
N = Not finished  
L = Laminated  
S = Stainless
- Refrigeration:**  
N = Self-contained  
R = Remote
- Door Hinge:**  
L = Left  
R = Right  
*left to right*



BB36L1BNH(L)

One door self-contained back bar cooler

**BB36** - - - - - **H( )**

- Refrigeration Compartment:**  
L = Left  
R = Right
- Base Height:**  
1 = 1"  
6 = 6" legs
- Door Style:**  
B = Black vinyl-clad  
U = Unlaminated  
L = Laminated  
S = Stainless  
G = Glass  
X = Stainless glass  
Y = Laminated glass
- Top Style:**  
N = Not finished  
L = Laminated  
S = Stainless
- Door Hinge:**  
L = Left  
R = Right  
*left to right*



BB60L1SSHRLR

Two door self-contained back bar cooler

**BB60** - - - - - **H( )**

- Refrigeration Compartment:**  
L = Left  
R = Right
- Base Height:**  
1 = 1"  
6 = 6" legs
- Door Style:**  
B = Black vinyl-clad  
U = Unlaminated  
L = Laminated  
S = Stainless  
G = Glass  
X = Stainless glass  
Y = Laminated glass
- Top Style:**  
N = Not finished  
L = Laminated  
S = Stainless
- Door Hinge:**  
L = Left  
R = Right  
*left to right*

**Self-Contained Back Bar Coolers**

More details available. Please visit [www.glastender.com](http://www.glastender.com)



BR60L1XS(LR)

**Create a model number by selecting from the options below:**

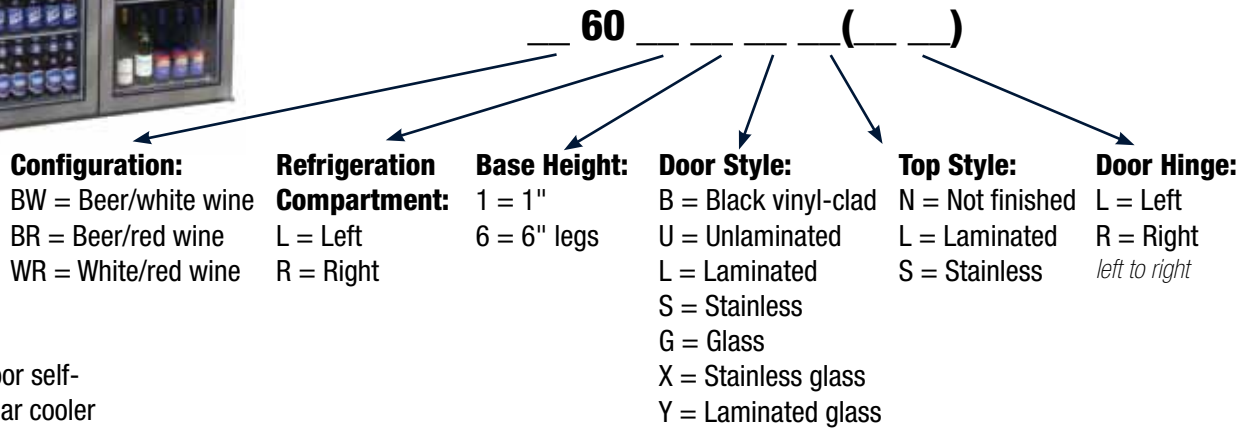

Dual zone two door self-contained back bar cooler



BB84R1LNH(LRR)

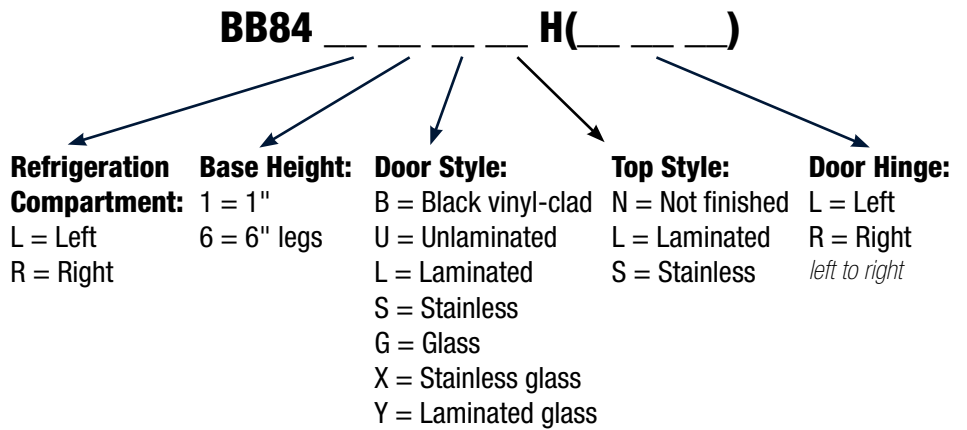

Three door self-contained back bar cooler



BB108L1BNH(LRLR)

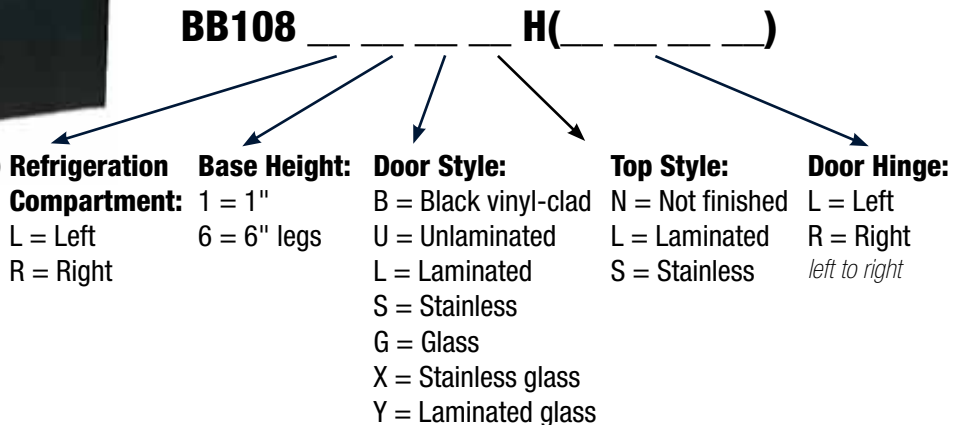

Four door self-contained back bar cooler

**Self-Contained Narrow Door Back Bar Coolers**

More details available. Please visit [www.glastender.com](http://www.glastender.com)

**Create a model number by selecting from the options below:**



ND52BRL1GS(RL)

Two door self-contained narrow door back bar cooler

**ND52** \_\_\_\_\_ ( \_\_\_\_\_ )

- Refrigeration Compartment:**  
L = Left  
R = Right
- Base Height:**  
1 = 1"  
6 = 6" legs
- Door Style:**  
B = Black vinyl-clad  
U = Unlaminated  
L = Laminated  
S = Stainless  
G = Glass  
X = Stainless glass  
Y = Laminated glass
- Top Style:**  
N = Not finished  
L = Laminated  
S = Stainless
- Door Hinge:**  
L = Left  
R = Right  
*left to right*



ND72R1GS(LRL)

Three door self-contained narrow door back bar cooler

**ND72** \_\_\_\_\_ ( \_\_\_\_\_ )

- Refrigeration Compartment:**  
L = Left  
R = Right
- Base Height:**  
1 = 1"  
6 = 6" legs
- Door Style:**  
B = Black vinyl-clad  
U = Unlaminated  
L = Laminated  
S = Stainless  
G = Glass  
X = Stainless glass  
Y = Laminated glass
- Top Style:**  
N = Not finished  
L = Laminated  
S = Stainless
- Door Hinge:**  
L = Left  
R = Right  
*left to right*

Four door self-contained narrow door back bar cooler

**ND92** \_\_\_\_\_ ( \_\_\_\_\_ )

- Refrigeration Compartment:**  
L = Left  
R = Right
- Base Height:**  
1 = 1"  
6 = 6" legs
- Door Style:**  
B = Black vinyl-clad  
U = Unlaminated  
L = Laminated  
S = Stainless  
G = Glass  
X = Stainless glass  
Y = Laminated glass
- Top Style:**  
N = Not finished  
L = Laminated  
S = Stainless
- Door Hinge:**  
L = Left  
R = Right  
*left to right*

Narrow door coolers are made to order and not returnable.

**Remote Back Bar Coolers**

More details available. Please visit [www.glastender.com](http://www.glastender.com)

**Create a model number by selecting from the options below:**

**BB48** \_\_\_\_\_ **N**( \_\_\_\_\_ )

Two door remote  
back bar cooler

- Remote Hook-Up Side:**  
L = Left  
R = Right
- Base Height:**  
1 = 1"  
6 = 6" legs
- Door Style:**  
B = Black vinyl-clad  
U = Unlaminated  
L = Laminated  
S = Stainless  
G = Glass  
X = Stainless glass  
Y = Laminated glass
- Top Style:**  
N = Not finished  
L = Laminated  
S = Stainless
- Door Hinge:**  
L = Left  
R = Right  
*left to right*

**BB72** \_\_\_\_\_ **N**( \_\_\_\_\_ )



BB72R1LNN(LRR)

Three door remote  
back bar cooler

- Remote Hook-Up Side:**  
L = Left  
R = Right
- Base Height:**  
1 = 1"  
6 = 6" legs
- Door Style:**  
B = Black vinyl-clad  
U = Unlaminated  
L = Laminated  
S = Stainless  
G = Glass  
X = Stainless glass  
Y = Laminated glass
- Top Style:**  
N = Not finished  
L = Laminated  
S = Stainless
- Door Hinge:**  
L = Left  
R = Right  
*left to right*



BB961LNN(LRLR)

Four door remote  
back bar cooler

**BB96** \_\_\_\_\_ **N**( \_\_\_\_\_ )

- Remote Hook-Up Side:**  
L = Left  
R = Right
- Base Height:**  
1 = 1"  
6 = 6" legs
- Door Style:**  
B = Black vinyl-clad  
U = Unlaminated  
L = Laminated  
S = Stainless  
G = Glass  
X = Stainless glass  
Y = Laminated glass
- Top Style:**  
N = Not finished  
L = Laminated  
S = Stainless
- Door Hinge:**  
L = Left  
R = Right  
*left to right*



**Remote Narrow Door Back Bar Coolers**

More details available. Please visit [www.glastender.com](http://www.glastender.com)

**Create a model number by selecting from the options below:**



ND40R1SSRR

Two door remote narrow door back bar cooler

**ND40** ( )

- Remote Hook-Up Side:**  
L = Left  
R = Right
- Base Height:**  
1 = 1"  
6 = 6" legs
- Door Style:**  
B = Black vinyl-clad  
U = Unlaminated  
L = Laminated  
S = Stainless  
G = Glass  
X = Stainless glass  
Y = Laminated glass
- Top Style:**  
N = Not finished  
L = Laminated  
S = Stainless
- Door Hinge:**  
L = Left  
R = Right  
*left to right*



ND60R1SSRRR

Three door remote narrow door back bar cooler

**ND60** ( )

- Remote Hook-Up Side:**  
L = Left  
R = Right
- Base Height:**  
1 = 1"  
6 = 6" legs
- Door Style:**  
B = Black vinyl-clad  
U = Unlaminated  
L = Laminated  
S = Stainless  
G = Glass  
X = Stainless glass  
Y = Laminated glass
- Top Style:**  
N = Not finished  
L = Laminated  
S = Stainless
- Door Hinge:**  
L = Left  
R = Right  
*left to right*

Four door remote narrow door back bar cooler

**ND80** ( )

- Remote Hook-Up Side:**  
L = Left  
R = Right
- Base Height:**  
1 = 1"  
6 = 6" legs
- Door Style:**  
B = Black vinyl-clad  
U = Unlaminated  
L = Laminated  
S = Stainless  
G = Glass  
X = Stainless glass  
Y = Laminated glass
- Top Style:**  
N = Not finished  
L = Laminated  
S = Stainless
- Door Hinge:**  
L = Left  
R = Right  
*left to right*

Narrow door coolers are made to order and not returnable.

## Self-Contained Low Profile Back Bar Coolers

More details available. Please visit [www.glastender.com](http://www.glastender.com)



LP60-R1-XS(LR)

Two door self-contained low profile back bar cooler

Create a model number by selecting from the options below:

**LP60** \_\_\_\_\_ ( \_\_\_\_\_ )

- Refrigeration Compartment:**  
L = Left  
R = Right
- Base Height:**  
1 = 1"  
6 = 6" legs
- Door Style:**  
B = Black vinyl-clad  
U = Unlaminated  
L = Laminated  
S = Stainless  
G = Glass  
X = Stainless glass  
Y = Laminated glass
- Top Style:**  
N = Not finished  
L = Laminated  
S = Stainless
- Door Hinge:**  
L = Left  
R = Right  
*left to right*

Three door self-contained low profile back bar cooler

**LP84** \_\_\_\_\_ ( \_\_\_\_\_ )

- Refrigeration Compartment:**  
L = Left  
R = Right
- Base Height:**  
1 = 1"  
6 = 6" legs
- Door Style:**  
B = Black vinyl-clad  
U = Unlaminated  
L = Laminated  
S = Stainless  
G = Glass  
X = Stainless glass  
Y = Laminated glass
- Top Style:**  
N = Not finished  
L = Laminated  
S = Stainless
- Door Hinge:**  
L = Left  
R = Right  
*left to right*

Four door self-contained narrow door back bar cooler

**LP108** \_\_\_\_\_ ( \_\_\_\_\_ )

- Refrigeration Compartment:**  
L = Left  
R = Right
- Base Height:**  
1 = 1"  
6 = 6" legs
- Door Style:**  
B = Black vinyl-clad  
U = Unlaminated  
L = Laminated  
S = Stainless  
G = Glass  
X = Stainless glass  
Y = Laminated glass
- Top Style:**  
N = Not finished  
L = Laminated  
S = Stainless
- Door Hinge:**  
L = Left  
R = Right  
*left to right*

Low profile coolers are made to order and not returnable.

## Remote Low Profile Back Bar Coolers

More details available. Please visit [www.glastender.com](http://www.glastender.com)



LP48L1BL(LR)

Two door remote low profile back bar cooler

Create a model number by selecting from the options below:

**LP48** \_\_\_\_\_ ( \_\_\_\_\_ )

**Remote Hook-Up Side:**  
L = Left  
R = Right

**Base Height:**  
1 = 1"  
6 = 6" legs

**Door Style:**  
B = Black vinyl-clad  
U = Unlaminated  
L = Laminated  
S = Stainless  
G = Glass  
X = Stainless glass  
Y = Laminated glass

**Top Style:**  
N = Not finished  
L = Laminated  
S = Stainless

**Door Hinge:**  
L = Left  
R = Right  
*left to right*

**LP72** \_\_\_\_\_ ( \_\_\_\_\_ )

**Remote Hook-Up Side:**  
L = Left  
R = Right

**Base Height:**  
1 = 1"  
6 = 6" legs

**Door Style:**  
B = Black vinyl-clad  
U = Unlaminated  
L = Laminated  
S = Stainless  
G = Glass  
X = Stainless glass  
Y = Laminated glass

**Top Style:**  
N = Not finished  
L = Laminated  
S = Stainless

**Door Hinge:**  
L = Left  
R = Right  
*left to right*

Three door remote low profile back bar cooler

**LP96** \_\_\_\_\_ ( \_\_\_\_\_ )

**Remote Hook-Up Side:**  
L = Left  
R = Right

**Base Height:**  
1 = 1"  
6 = 6" legs

**Door Style:**  
B = Black vinyl-clad  
U = Unlaminated  
L = Laminated  
S = Stainless  
G = Glass  
X = Stainless glass  
Y = Laminated glass

**Top Style:**  
N = Not finished  
L = Laminated  
S = Stainless

**Door Hinge:**  
L = Left  
R = Right  
*left to right*

Four door remote low profile back bar cooler

Low profile coolers are made to order and not returnable.

## Self-Contained Pass-Thru Coolers

More details available. Please visit [www.glastender.com](http://www.glastender.com)



PT60L1LLH(LR/RL)

Four door self-contained pass-thru cooler

Create a model number by selecting from the options below:

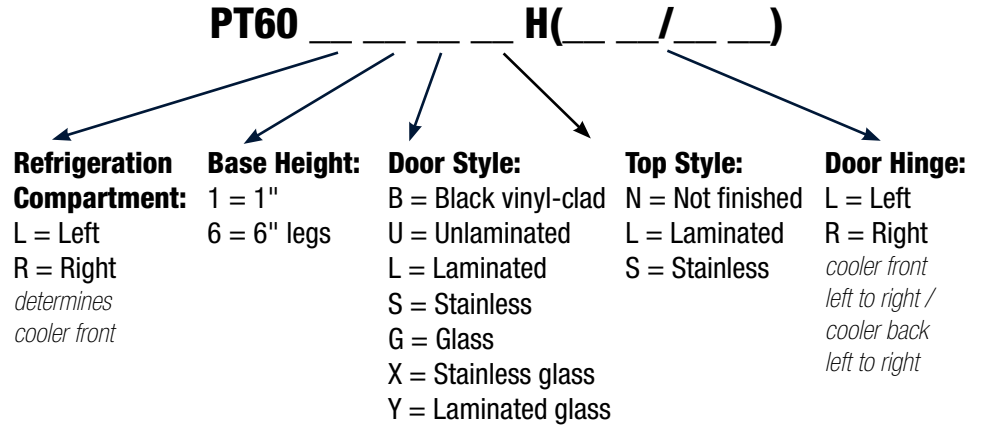

Six door self-contained pass-thru cooler

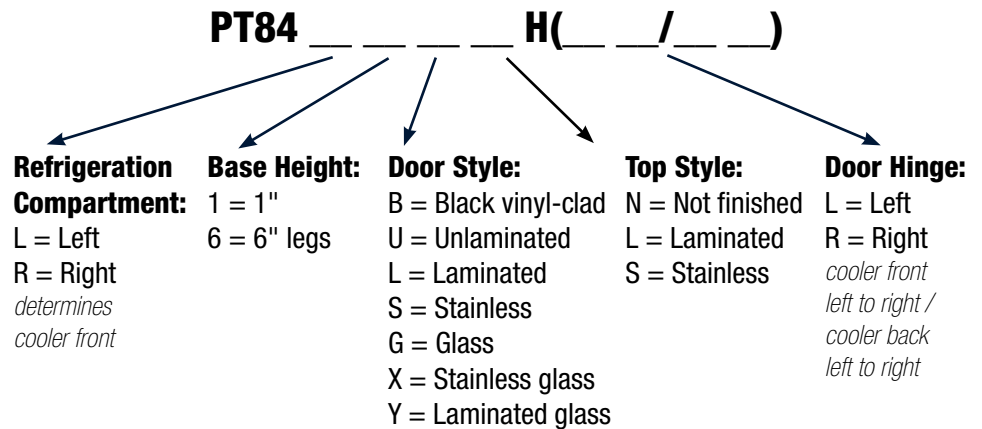

Eight door self-contained pass-thru cooler

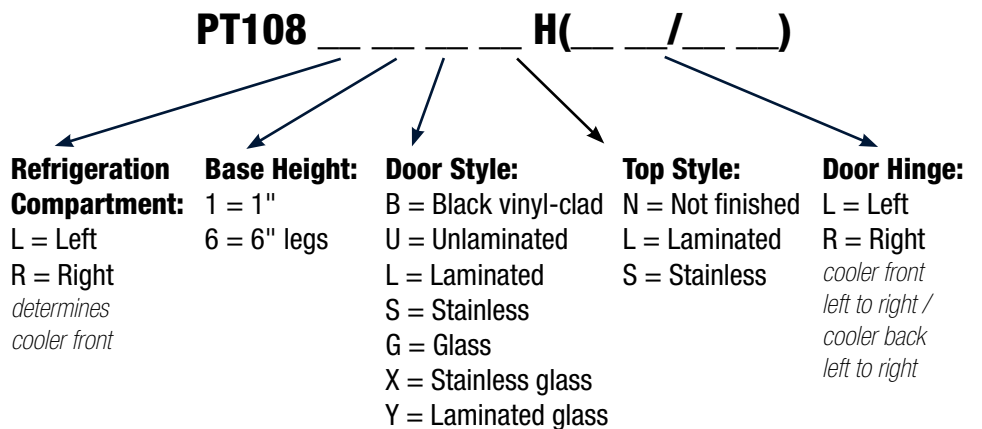

Pass-thru coolers are made to order and not returnable.

## Remote Pass-Thru Coolers

More details available. Please visit [www.glastender.com](http://www.glastender.com)



Four door remote pass-thru cooler

Create a model number by selecting from the options below:

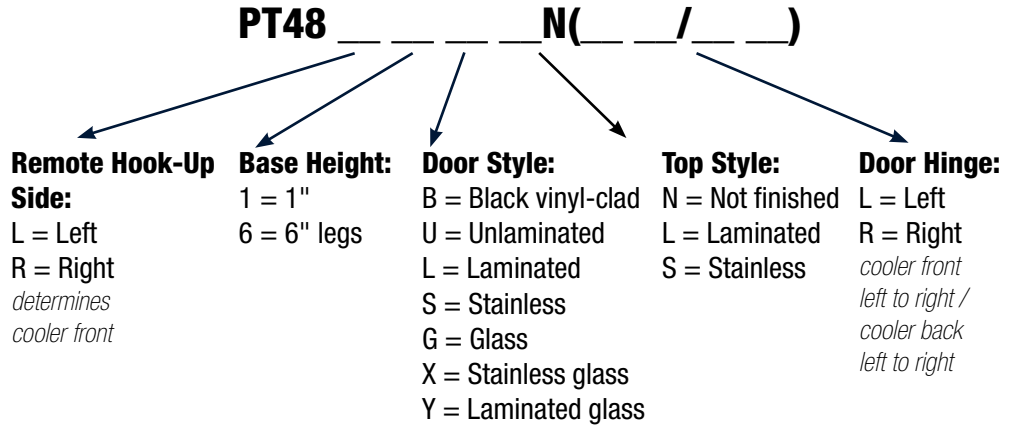

Six door remote pass-thru cooler

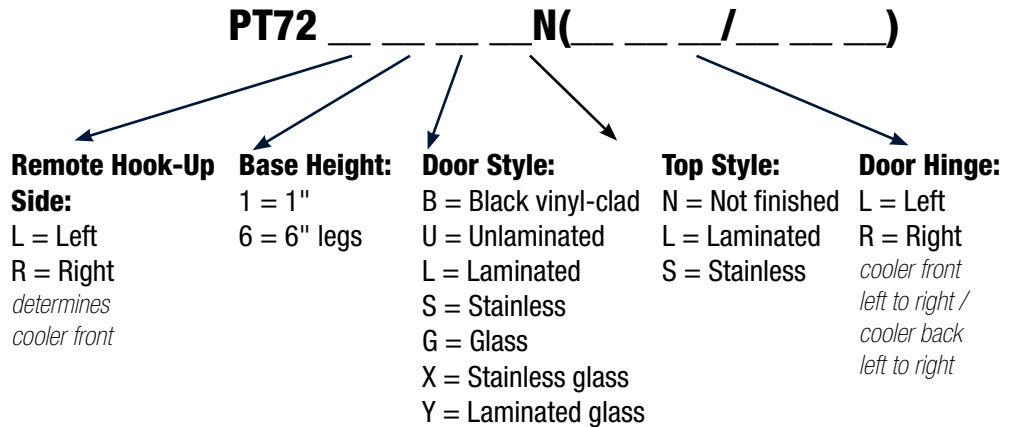

Six door remote pass-thru cooler

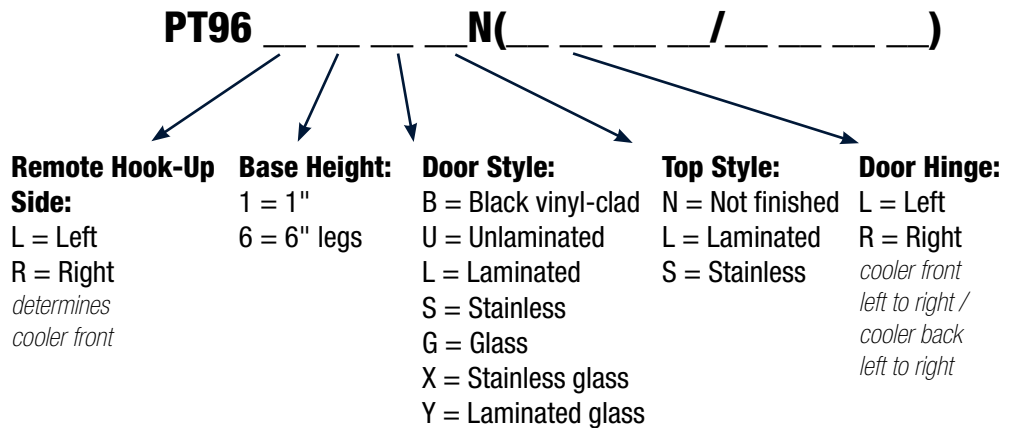

Pass-thru coolers are made to order and not returnable.

## Front Venting Coolers

More details available. Please visit [www.glastender.com](http://www.glastender.com)

Create a model number by selecting from the options below:



FV24SS(L)

One door self-contained front venting cooler

**FV24** — ( )

- |                      |                   |                    |
|----------------------|-------------------|--------------------|
| <b>Door Style:</b>   | <b>Top Style:</b> | <b>Door Hinge:</b> |
| B = Black vinyl-clad | N = Not finished  | L = Left           |
| U = Unlaminated      | L = Laminated     | R = Right          |
| L = Laminated        | S = Stainless     |                    |
| S = Stainless        |                   |                    |
| G = Glass            |                   |                    |
| X = Stainless glass  |                   |                    |
| Y = Laminated glass  |                   |                    |



Two door self-contained front venting cooler

**FV48** — (LR)

- |                      |                   |  |
|----------------------|-------------------|--|
| <b>Door Style:</b>   | <b>Top Style:</b> |  |
| B = Black vinyl-clad | N = Not finished  |  |
| U = Unlaminated      | L = Laminated     |  |
| L = Laminated        | S = Stainless     |  |
| S = Stainless        |                   |  |
| G = Glass            |                   |  |
| X = Stainless glass  |                   |  |
| Y = Laminated glass  |                   |  |

*Door hinging is only available left-right*

## Self-Contained Reach-In Mug Chiller



MFV24SS(L)

One door self-contained front venting cooler

**MFV24** — ( )

- |                      |                   |                    |
|----------------------|-------------------|--------------------|
| <b>Door Style:</b>   | <b>Top Style:</b> | <b>Door Hinge:</b> |
| B = Black vinyl-clad | N = Not finished  | L = Left           |
| U = Unlaminated      | L = Laminated     | R = Right          |
| L = Laminated        | S = Stainless     |                    |
| S = Stainless        |                   |                    |
| G = Glass            |                   |                    |
| X = Stainless glass  |                   |                    |
| Y = Laminated glass  |                   |                    |

## Self-Contained Keg Coolers

More details available. Please visit [www.glastender.com](http://www.glastender.com)



Note: faucet handles are not included

KC24NCBS2R  
Shown with optional 2-faucet column tower for use with 1/6 barrel mini kegs



KC60L1BS(LR)



KC72L1BS(LR)

Create a model number by selecting from the options below:

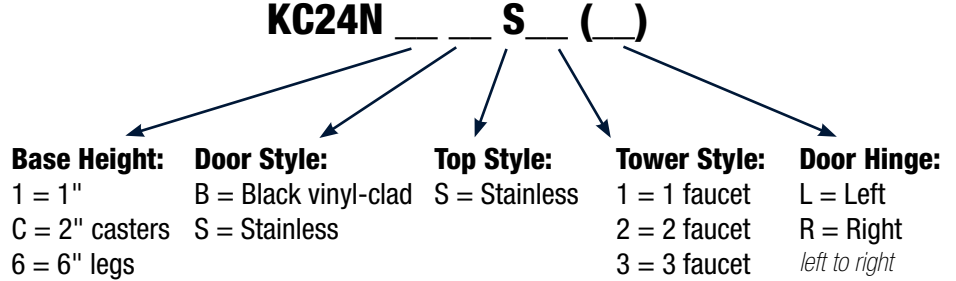

*Stainless steel top has full length recessed drainer*

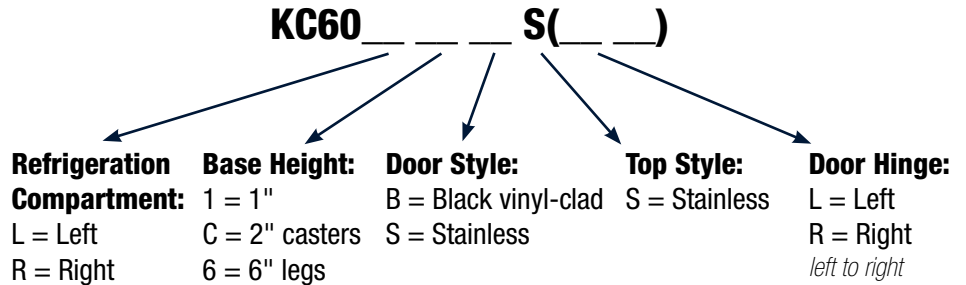

*Stainless steel top has full length recessed drainer*

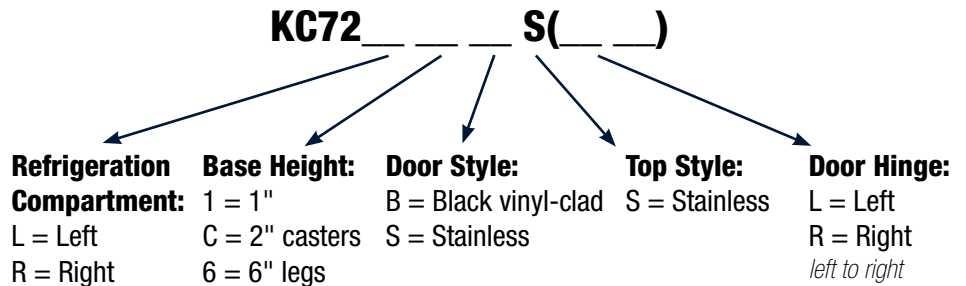

*Stainless steel top has full length recessed drainer*

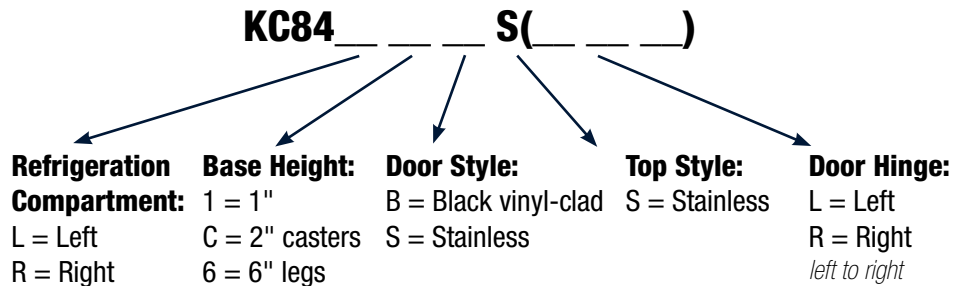

*Stainless steel top has full length recessed drainer*

## Slide Top Coolers

More details available. Please visit [www.glastender.com](http://www.glastender.com)



Part #	Description
C-4X4	3-3/4" casters, set of four
C-6X4	3-3/4" casters, set of six
STLS-4	6" leg set, set of four
STLS-6	6" leg set, set of six
BO/CC	Bottle opener/cap catcher
STKR-24	24" kick rail
STKR-36	36" kick rail
STKR-48	48" kick rail
STKR-60	60" kick rail
STKR-72	72" kick rail
STKR-96	96" kick rail
STBS-24	24" slide top backsplash
STBS-36	36" slide top backsplash
STBS-48	48" slide top backsplash
STBS-60	60" slide top backsplash
STBS-72	72" slide top backsplash
STBS-96	96" slide top backsplash
08000082	Chrome divider rack (extra)
CE-220/50S	Convert self contained unit to 220V/50Hz electrical

## Galvanized Steel Interior with Stainless Steel Floor

Dimensions"	Black Vinyl-Clad	Stainless Front & Sides	All Stainless	Divider Racks	Case Capacity Bottles
24W x 24D x 34.5H	ST24-BG	ST24-SFG	ST24-SG*	1	4.83
36W x 24D x 34.5H	ST36-BG	ST36-SFG	ST36-SG*	2	7.25
48W x 24D x 34.5H	ST48-BG	ST48-SFG	ST48-SG*	3	13.63
60W x 24D x 34.5H	ST60-BG	ST60-SFG	ST60-SG*	4	19.82
72W x 24D x 34.5H	ST72-BG	ST72-SFG	ST72-SG*	4	24.75
96W x 24D x 34.5H			ST96-SG*	5	32.17

\*Made to order and not returnable.

## Stainless Steel Interior

Dimensions"	Black Vinyl-Clad	Stainless Front & Sides	All Stainless	Divider Racks	Case Capacity Bottles
24W x 24D x 34.5H	ST24-B	ST24-SF	ST24-S	1	4.83
36W x 24D x 34.5H	ST36-B	ST36-SF	ST36-S	2	7.25
48W x 24D x 34.5H	ST48-B	ST48-SF	ST48-S	3	13.63
60W x 24D x 34.5H	ST60-B	ST60-SF	ST60-S*	4	19.82
72W x 24D x 34.5H	ST72-B	ST72-SF	ST72-S*	4	24.75
96W x 24D x 34.5H	ST96-B	ST96-SF*	ST96-S*	5	32.17



## Cooler Parts and Accessories

More details available. Please visit [www.glastender.com](http://www.glastender.com)



Back bar coolers can be converted to draft beer dispensing and are available with many accessories.

The BB84 model shown has two doors converted to draft beer dispensing and a two-faucet column tower. Other accessories include raised panel wood doors, laminated finished top, ice display unit, and lighted liquor display.

Part #	Description
DH-PBU	Upgrade to brass handle
CKR-24	24" kick rail
CKR-36	36" kick rail
CKR-40	40" kick rail
CKR-48	48" kick rail
CKR-52	52" kick rail
CKR-60	60" kick rail
CKR-72	72" kick rail
CKR-80	80" kick rail
CKR-84	84" kick rail
CKR-92	92" kick rail
CKR-96	96" kick rail
CKR-108	108" kick rail
CKR-L	Left side kick rail
CKR-R	Right side kick rail

Part #	Description
SL-L	Left side lamination
SL-R	Right side lamination
SS-L	Left side stainless steel
SS-R	Right side stainless steel
C-4X4	4" casters, set of four, BB24, BB60, ND52, LP60, PT60, KC60
C-5X4	4" casters, set of five, BB36
C-6X4	4" casters, set of six, BB84, BB108, ND72, ND92, LP84, LP108, PT84, PT108, KC72, KC84
CBS/SS-48	48" stainless backsplash for low profile cooler
CBS/SS-60	60" stainless backsplash for low profile cooler
CBS/SS-72	72" stainless backsplash for low profile cooler
CBS/SS-84	84" stainless backsplash for low profile cooler
CBS/SS-96	96" stainless backsplash for low profile cooler
CBS/SS-108	108" stainless backsplash for low profile cooler
CE-220/50S	Convert self contained unit to 220V/50Hz electrical

## Cooler Parts and Accessories

More details available. Please visit [www.glastender.com](http://www.glastender.com)



06003690



BO/CC

Part #	Description
CROSS-RR	Crossover tube assy w 100 CFM blower motor from one refrigerator to another, 30"
CROSS-WR	Crossover tube assy w 100 CFM blower motor from a walk-in cooler to refrigerator, 30"
CROSS-WT	Crossover tube assy w 100 CFM blower motor from a walk-in cooler to wall mount tower, 30"
SHAFT-RT	Air shaft assy w 100 CFM blower motor from refrigerator to beer tower, 72"
SHAFT-WT	Air shaft assy w 100 CFM blower motor from walk-in cooler to beer tower, 72"
06001446	Blower motor, 15 CFM
06001447	Blower motor, 60 CFM
06001450	Blower motor, 100 CFM
BB800005	15CFM blower, converts back bar refrigerator into direct draw system
BB800007	12CFM blower, converts back bar refrigerator into direct draw system

Part #	Description
CBS/SS_	SS backsplash, _ specify needed length in inches
CBS/SS-L	SS side splash, left, 4"
CBS/SS-R	SS side splash, right, 4"
SB-24	SS back upgrade for 24" cooler
SB-36	SS back upgrade for 36" cooler
SB-48	SS back upgrade for 48" cooler
SB-52	SS back upgrade for 52" cooler
SB-60	SS back upgrade for 60" cooler
SB-72	SS back upgrade for 72" cooler
SB-84	SS back upgrade for 84" cooler
SB-96	SS back upgrade for 96" cooler
SB-108	SS back upgrade for 108" cooler
06003690	Wine rack shelf, SS, slots for 9 bottles for 24" door
06003938	Wine rack shelf, SS, slots for 7 bottles for 20" door
06006264	Wine rack shelf SS slots for 7 bottles for BB & LP with 2" thick walls, 20" door opening
06006265	Wine rack shelf SS slots for 5 bottles for ND with 2" thick walls, 16" door opening
BO/CC	Bottle opener & cap catcher

## 24" Deep Back Bar Storage Units

Storage units have stainless steel interiors with black vinyl-clad or stainless steel exteriors. Stainless steel or laminated tops are sold separately. Bar liquor display (BLD) features a built-in light for illuminating bottles, radius step edges for easy cleaning, and step covers to reduce bottle noise. Bar glass storage (BGS) has four shelves for maximum storage capacity and radius shelf corners for easy cleaning.

More details available. Please visit [www.glastender.com](http://www.glastender.com)



BGS



BLD



BLD

Description	Black	Stainless	Length"
Bar glass storage	BGS-18	BGS-18-S	18
Bar glass storage	BGS-24	BGS-24-S	24
Bar glass storage	BGS-30	BGS-30-S	30
Bar liquor display	BLD-18	BLD-18-S	18
Bar liquor display	BLD-24	BLD-24-S	24
Bar liquor display	BLD-30	BLD-30-S	30
Bar liquor display	BLD-36	BLD-36-S	36
Bar liquor display	BLD-42	BLD-42-S	42
Bar liquor display	BLD-48	BLD-48-S	48
BLD locking cover	BLC-18	BLC-18-S	18
BLD locking cover	BLC-24	BLC-24-S	24
BLD locking cover	BLC-30	BLC-30-S	30
BLD locking cover	BLC-36	BLC-36-S	36
BLD locking cover	BLC-42	BLC-42-S	42
BLD locking cover	BLC-48	BLC-48-S	48

Description	Laminate	Stainless	Length"
Finished top	TOP-18-L	TOP-18-S	18
Finished top	TOP-24-L	TOP-24-S	24
Finished top	TOP-30-L	TOP-30-S	30
Finished top	TOP-36-L	TOP-36-S	36
Finished top	TOP-42-L	TOP-42-S	42
Finished top	TOP-48-L	TOP-48-S	48
SS kick rail		CKR-18	18
SS kick rail		CKR-24	24
SS kick rail		CKR-30	30
SS kick rail		CKR-36	36
SS kick rail		CKR-42	42
SS kick rail		CKR-48	48
6" legs, set of 4		CLS-4	6

## Margarita Machine Stand

Interior is galvanized steel with insulation for extra sturdiness. Stainless steel pull handle, and 180° door swing. Top is stainless with 1" high back and side splashes.

Replace the blank ( ) in the part number with R or L for door hinge.



MS20SS

Description	Black	Stainless	Length"
1 door margarita stand	MS20-BS( )	MS20-SS( )	20
1 door margarita stand	MS24-BS( )	MS24-SS( )	24
2 door margarita stand	MS44-BS	MS44-SS	44
2 door margarita stand	MS48-BS	MS48-SS	48

## Condensing Unit Storage Cabinet



Create a model number:  
**CS18-N \_ \_ N**

**Base Height:**  
1 = 1"  
6 = 6" legs

**Front Finish:**  
B = Black vinyl-clad  
S = Stainless

**Top Style:**  
N = Not finished  
L = Laminated  
S = Stainless

## Dry Storage Cabinets

More details available. Please visit [www.glastender.com](http://www.glastender.com)



LPDS241BLR  
Low profile dry storage cabinet



DS241BSR  
One door dry storage cabinet

Create a model number by selecting from the options below:

**LPDS24-** \_\_\_\_\_ **( )**

<b>Base Height:</b> 1 = 1" 6 = 6" legs	<b>Door Style:</b> B = Black vinyl-clad U = Unlaminated L = Laminated S = Stainless	<b>Top Style:</b> N = No finish L = Laminate S = Stainless	<b>Door Hinge:</b> L = Left R = Right <i>left to right</i>
--	---	---	---

**DS24-N** \_\_\_\_\_ **( )**

<b>Base Height:</b> 1 = 1" 6 = 6" legs	<b>Door Style:</b> B = Black vinyl-clad U = Unlaminated L = Laminated S = Stainless	<b>Top Style:</b> N = No finish L = Laminate S = Stainless	<b>Door Hinge:</b> L = Left R = Right <i>left to right</i>
--	---	---	---

Two door dry storage cabinet

**DS48-N** \_\_\_\_\_ **N( )**

<b>Base Height:</b> 1 = 1" 6 = 6" legs	<b>Door Style:</b> B = Black vinyl-clad U = Unlaminated L = Laminated S = Stainless	<b>Top Style:</b> N = No finish L = Laminate S = Stainless	<b>Door Hinge:</b> L = Left R = Right <i>left to right</i>
--	---	---	---

Three door dry storage cabinet

**DS72-N** \_\_\_\_\_ **N( )**

<b>Base Height:</b> 1 = 1" 6 = 6" legs	<b>Door Style:</b> B = Black vinyl-clad U = Unlaminated L = Laminated S = Stainless	<b>Top Style:</b> N = No finish L = Laminate S = Stainless	<b>Door Hinge:</b> L = Left R = Right <i>left to right</i>
--	---	---	---

Part #	Description
DH-PBU	Upgrade to brass handle
CKR-24	24" kick rail
CKR-48	48" kick rail
CKR-72	72" kick rail
CKR-L	Left side kick rail
CKR-R	Right side kick rail
SL/LP-L	Left side lamination, LPDS24
SL/LP-R	Right side lamination, LPDS24
SS/LP-L	Left side stainless steel, LPDS24
SS/LP-R	Right side stainless steel, LPDS24
SL-L	Left side lamination, DS
SL-R	Right side lamination, DS
SS-L	Left side stainless steel, DS
SS-R	Right side stainless steel, DS
C-4X4	4" casters, set of four, LPDS24
C-6X4	4" casters, set of six, DS

## Ice Display Units

Ice display units (IDU) can be factory mounted to the top of Back Bar, Narrow Door, Low Profile, Pass-Thru, Front Venting, and Rear Feed Coolers and Dry Storage Cabinets. IDUs are 7" high with 6" deep liner, 1/2" tall perforated bottom insert, and all stainless steel construction. Insulation and a breaker strip around the ice bin provide a thermal barrier. Stainless steel front, back and sides are standard; black vinyl-clad is optional.

Glass ice display units (GDU) have double pane glass front and back with stainless steel trim, perforated insert and insulated end panels. Units larger than 54" include a center partition. Factory installed ice displays include a special stainless steel 1.5" high (not the standard 1" high) insulated cooler top with a built-in drain pan. Field installed units include a stainless steel insulated drain pan to mount to an existing countertop.

All ice displays are made to order and not returnable.

Part #	Dimensions"	Part #	Dimensions"
GDU-12X24	12D x 24L x 7H	GDU-18X24	18D x 24L x 7H
GDU-12X30	12D x 30L x 7H	GDU-18X30	18D x 30L x 7H
GDU-12X36	12D x 36L x 7H	GDU-18X36	18D x 36L x 7H
GDU-12X42	12D x 42L x 7H	GDU-18X42	18D x 42L x 7H
GDU-12X48	12D x 48L x 7H	GDU-18X48	18D x 48L x 7H
GDU-12X54	12D x 54L x 7H	GDU-18X54	18D x 54L x 7H
GDU-12X60	12D x 60L x 7H	GDU-18X60	18D x 60L x 7H
GDU-12X66	12D x 66L x 7H	GDU-18X66	18D x 66L x 7H
GDU-12X72	12D x 72L x 7H	GDU-18X72	18D x 72L x 7H
GDU-12X78	12D x 78L x 7H	GDU-18X78	18D x 78L x 7H
GDU-12X84	12D x 84L x 7H	GDU-18X84	18D x 84L x 7H
GDU-12X90	12D x 90L x 7H	GDU-18X90	18D x 90L x 7H
GDU-12X96	12D x 96L x 7H	GDU-18X96	18D x 96L x 7H
GDU-12X102	12D x 102L x 7H	GDU-18X102	18D x 102L x 7H
GDU-12X108	12D x 108L x 7H	GDU-18X108	18D x 108L x 7H
GDU-16X102	16D x 102L x 7H	GDU-24X24	24D x 24L x 7H
GDU-16X108	16D x 108L x 7H	GDU-24X30	24D x 30L x 7H
GDU-16X24	16D x 24L x 7H	GDU-24X36	24D x 36L x 7H
GDU-16X30	16D x 30L x 7H	GDU-24X42	24D x 42L x 7H
GDU-16X36	16D x 36L x 7H	GDU-24X48	24D x 48L x 7H
GDU-16X42	16D x 42L x 7H	GDU-24X54	24D x 54L x 7H
GDU-16X48	16D x 48L x 7H	GDU-24X60	24D x 60L x 7H
GDU-16X54	16D x 54L x 7H	GDU-24X66	24D x 66L x 7H
GDU-16X60	16D x 60L x 7H	GDU-24X72	24D x 72L x 7H
GDU-16X66	16D x 66L x 7H	GDU-24X78	24D x 78L x 7H
GDU-16X72	16D x 72L x 7H	GDU-24X84	24D x 84L x 7H
GDU-16X78	16D x 78L x 7H	GDU-24X90	24D x 90L x 7H
GDU-16X84	16D x 84L x 7H	GDU-24X96	24D x 96L x 7H
GDU-16X90	16D x 90L x 7H	GDU-24X102	24D x 102L x 7H
GDU-16X96	16D x 96L x 7H	GDU-24X108	24D x 108L x 7H

More details available. Please visit [www.glastender.com](http://www.glastender.com)

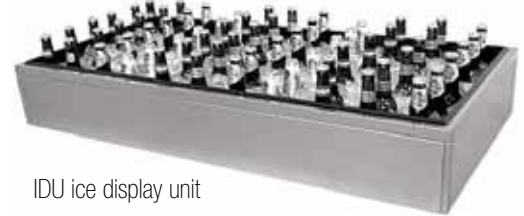

IDU ice display unit



Factory installed GDU on 1.5" high insulated cooler top (not std 1" high) with built-in drain pan

Part #	Dimensions"	Part #	Dimensions"
IDU-12X24	12D x 24L x 7H	IDU-18X72	18D x 72L x 7H
IDU-12X30	12D x 30L x 7H	IDU-18X78	18D x 78L x 7H
IDU-12X36	12D x 36L x 7H	IDU-18X84	18D x 84L x 7H
IDU-12X42	12D x 42L x 7H	IDU-18X90	18D x 90L x 7H
IDU-12X48	12D x 48L x 7H	IDU-18X96	18D x 96L x 7H
IDU-12X54	12D x 54L x 7H	IDU-18X102	18D x 102L x 7H
IDU-12X60	12D x 60L x 7H	IDU-18X108	18D x 108L x 7H
IDU-12X66	12D x 66L x 7H	IDU-24X24	24D x 24L x 7H
IDU-12X72	12D x 72L x 7H	IDU-24X30	24D x 30L x 7H
IDU-12X78	12D x 78L x 7H	IDU-24X36	24D x 36L x 7H
IDU-12X84	12D x 84L x 7H	IDU-24X42	24D x 42L x 7H
IDU-12X90	12D x 90L x 7H	IDU-24X48	24D x 48L x 7H
IDU-12X96	12D x 96L x 7H	IDU-24X54	24D x 54L x 7H
IDU-12X102	12D x 102L x 7H	IDU-24X60	24D x 60L x 7H
IDU-12X108	12D x 108L x 7H	IDU-24X66	24D x 66L x 7H
IDU-18X24	18D x 24L x 7H	IDU-24X72	24D x 72L x 7H
IDU-18X30	18D x 30L x 7H	IDU-24X78	24D x 78L x 7H
IDU-18X36	18D x 36L x 7H	IDU-24X84	24D x 84L x 7H
IDU-18X42	18D x 42L x 7H	IDU-24X90	24D x 90L x 7H
IDU-18X48	18D x 48L x 7H	IDU-24X96	24D x 96L x 7H
IDU-18X54	18D x 54L x 7H	IDU-24X102	24D x 102L x 7H
IDU-18X60	18D x 60L x 7H	IDU-24X108	24D x 108L x 7H
IDU-18X66	18D x 66L x 7H		

## Lighted Liquor Displays

Lighted liquor displays (LLD) have illuminated 4" high and 4" deep steps with black vinyl-clad exterior, clear acrylic step cover, on/off switch, grounded cord and plug, and removable top for easy access to fluorescent light bulbs (included).

All ice displays are made to order and not returnable.

*R or L part number suffix designates power cord position.*

More details available. Please visit [www.glastender.com](http://www.glastender.com)

Glass display unit lighted liquor displays are taller than standard lighted liquor displays. The first step is 9.25" high to raise the bottles above the glass display unit, and it has a front light channel to help illuminate the GDU to add visual appeal. When mounted on a cooler at the factory, the 16" deep GDU models have a 8.25" rear deck space designed to fit the 8" deep LLD.

Factory mounted LLD behind glass display unit (GDU)



LLDS



LLD3



LLD

## Two Tier Displays

Part #	Part #	Dimensions"
LLDS-24L	LLDS-24R	24L x 8D x 8H
LLDS-30L	LLDS-30R	30L x 8D x 8H
LLDS-36L	LLDS-36R	36L x 8D x 8H
LLDS-42L	LLDS-42R	42L x 8D x 8H
LLDS-48L	LLDS-48R	48L x 8D x 8H
LLDS-54L	LLDS-54R	54L x 8D x 8H
LLDS-60L	LLDS-60R	60L x 8D x 8H
LLDS-66L	LLDS-66R	66L x 8D x 8H
LLDS-72L	LLDS-72R	72L x 8D x 8H
LLDS-78L	LLDS-78R	78L x 8D x 8H
LLDS-84L	LLDS-84R	84L x 8D x 8H
LLDS-90L	LLDS-90R	90L x 8D x 8H
LLDS-96L	LLDS-96R	96L x 8D x 8H
LLDS-102L	LLDS-102R	102L x 8D x 8H
LLDS-108L	LLDS-108R	108L x 8D x 8H

## Three Tier Displays

Part #	Part #	Dimensions"
LLD3-24L	LLD3-24R	24L x 8D x 12H
LLD3-30L	LLD3-30R	30L x 8D x 12H
LLD3-36L	LLD3-36R	36L x 8D x 12H
LLD3-42L	LLD3-42R	42L x 8D x 12H
LLD3-48L	LLD3-48R	48L x 8D x 12H
LLD3-54L	LLD3-54R	54L x 8D x 12H
LLD3-60L	LLD3-60R	60L x 8D x 12H
LLD3-66L	LLD3-66R	66L x 8D x 12H
LLD3-72L	LLD3-72R	72L x 8D x 12H
LLD3-78L	LLD3-78R	78L x 8D x 12H
LLD3-84L	LLD3-84R	84L x 8D x 12H
LLD3-90L	LLD3-90R	90L x 8D x 12H
LLD3-96L	LLD3-96R	96L x 8D x 12H
LLD3-102L	LLD3-102R	102L x 8D x 12H
LLD3-108L	LLD3-108R	108L x 8D x 12H

## GDU Two Tier Displays

Part #	Part #	Dimensions"
LLD-24L	LLD-24R	24L x 8D x 13H
LLD-30L	LLD-30R	30L x 8D x 13H
LLD-36L	LLD-36R	36L x 8D x 13H
LLD-42L	LLD-42R	42L x 8D x 13H
LLD-48L	LLD-48R	48L x 8D x 13H
LLD-54L	LLD-54R	54L x 8D x 13H
LLD-60L	LLD-60R	60L x 8D x 13H
LLD-66L	LLD-66R	66L x 8D x 13H
LLD-72L	LLD-72R	72L x 8D x 13H
LLD-78L	LLD-78R	78L x 8D x 13H
LLD-84L	LLD-84R	84L x 8D x 13H
LLD-90L	LLD-90R	90L x 8D x 13H
LLD-96L	LLD-96R	96L x 8D x 13H
LLD-102L	LLD-102R	102L x 8D x 13H
LLD-108L	LLD-108R	108L x 8D x 13H

The diagrams on pages 1-4 are courtesy of Micro Matic USA, Inc., Brooksville, Florida.

Lancer, Highlight, Fatlock, Siberian Elite, Polaris Beer Superchiller, Multifill, Breeze, BreezeR and Unicorn are trademarks or registered trademarks of Hoshizaki Lancer Corporation, San Antonio, Texas.

Vin Service and QUIX tap are trademarks of Vin Service Srl, Zanica, Italy.

Perlick is a registered trademark of Perlick Corporation, Milwaukee, Wisconsin.

Procon is a registered trademark of Procon Products, Standex International Corporation, Murfreesboro, Tennessee.

Bev-Seal, Bev-Steel, Bevlex, Bev-Flex, Clearbraid and Glas-Flex are registered trademarks of Accuflex Industrial Hose, Ltd., Guelph, ON, Canada, a subsidiary of Kuriyama of America, Inc. Bev-Seal Ultra, Polyspring, Klearon, Tigerflex and Sani-Clean AM are registered trademarks of Kuriyama of America, Inc., Schaumburg, Illinois.

Armiflex is a registered trademark of Armacell LLC, Mebane, North Carolina.

Kwik Block is a trademark of Kwik Block Fastening Systems, Rogue River, Oregon.

Tru-Gap is a trademark of Tru-Gap LLC, St. Paul, Minnesota.

Omega is a registered trademark of Omega Products, Inc., Harrisburg, Pennsylvania.

Wunder-Bar and Mark 4 are registered trademarks of Automatic Bar Controls, Inc., Vacaville, California.

McCann's and TruPour are registered trademarks of The Manitowoc Company, Manitowoc, Wisconsin.

Exactap is a registered trademark of DigitalDispense, London, United Kingdom.

Tecflo is a registered trademark of Tecflo Energy Services Ltd, Norfolk, United Kingdom.

Flojet is a registered trademark of ITT Industries, Foothill Ranch, California.

SHURflo is a registered trademark of SHURflo, LLC, Cypress, California.

Taprite is a registered trademark of Taprite-Fassco Mfg., Inc., San Antonio, Texas.

Catalina is a registered trademark of Catalina Cylinders, Inc., Garden Grove, California.

DraftMore is a registered trademark of DraftMore APS, Nordborgvej, Denmark.

Senco is a registered trademark of Senco Brands Inc., Cincinnati, Ohio.

Nitro-Blend is a trademark of Green CO2 Systems, Fort Collins, Colorado.

Trumix is a registered trademark of McDantim Gas Blending Technologies, Helena, Montana.

Oetiker is a registered trademark of Oetiker International, Marlette, Michigan.

John Guest and Speedfit are registered trademarks of John Guest International Ltd., Fairfield, New Jersey.

Colder is a registered trademark of Colder Products Company, St. Paul, Minnesota.

Stow 'N Go, ProLatch, StowAway and Lockjaw are trademarks of Plano Molding Company, Plano, Illinois.

BevClean and WinterBev are trademarks of Beverage Cleaning Solutions, LLC Dayton, Ohio.

Draftec is a trademark of Applied Cleaning Technologies, Inc., Scottsdale, Arizona.

ScaleKleen is a registered trademark of Everpure, Inc., Hanover Park, Illinois.

Clear1 is a trademark of Scotsman Ice Systems, Vernon Hills, Illinois.

Nu-Brite, Foam-Brite, Alka-Brite, Evap Foam No Rinse, Nu-Blast, Cal-Blast, Cal-Green, Evap-Green, Evap Fresh No Rinse, and CalClean are trademarks or registered trademarks of NuCalgon, St. Louis, Missouri.

Glastender is a registered trademark of Glastender, Inc., Saginaw, Michigan.

INFINITY is a trademark of Sterling Pressure Systems, San Antonio, Texas.

LogiCO2, MK7, MK9 and MK10 are trademarks of LogiCO2 International AB, Västra Frölunda, Sweden.

PourMyBeer is a trademark of Innovative Tap Solutions Company, Wheeling, Illinois.

By The Glass is a registered trademark of By The Glass International, Haarlem, Neherlands.

Blendtec is a registered trademark of Blendtec Inc., Orem, Utah.

**Bar Equipment Shopping List**

Qty	Description	Part Number	Comments
	Tower 1		
	Tower 2		
	Tower 3		
	Faucets & locks		
	Faucet handles		
	Medallions		
	Shanks & grommets		
	Drip tray 1		
	Drip tray 2		
	Drip tray 3		
	Glycol chiller		
	Chiller plate		
	Glycol		
	Glycol manifold		
	Insulated trunk line		
	Single line barrier tubing		
	PVC hose		
	Drain tubing		
	Thickened water assembly		
	Beer hose assemblies		
	PVC tubing raceway		
	Tubing chase		
	Conduit straps		
	Kwik blocks		
	Tru-gap backflow preventer		
	Metal tubing		
	Tubing cutter & pincer		
	Hose clamps		
	Tape		
	Lubricants		
	Armaflex pipe insulation		
	Cable ties		
	Line labels and clips		
	Blenders & accessories		
	Liquor chiller		
	Unicorn soda tower		
	Bar guns & button caps		
	Ice chest		
	Cold plate and ice shield		



**Bar Equipment Shopping List**

Qty	Description	Part Number	Comments
	Conversion stand/leg kit		
	Couplers/taps		
	FOB stops/empty keg detectors		
	Beer and wine pumps		
	Flow reversal valve		
	Flow meter		
	Pump panels		
	Equipment mounting boards		
	CO <sub>2</sub> Primary regulators		
	CO <sub>2</sub> Secondary regulators		
	CO <sub>2</sub> regulators/reg panels		
	Nitrogen regulators		
	Gov Reg and tester/adjuster		
	DraftMore beer regulators		
	High pressure hose assy		
	Gauge guards		
	Regulator wrench		
	CO <sub>2</sub> pressure tester		
	Carbonation tester/refractometer		
	CO <sub>2</sub> shutoff valves		
	Ceiling mt, self-store gas hose		
	CO <sub>2</sub> tank outdoor storage cabinet		
	CO <sub>2</sub> tanks, handles & brackets		
	CO <sub>2</sub> purifier		
	Changeovers valves		
	CO <sub>2</sub> tank auto changeover		
	CO <sub>2</sub> and O <sub>2</sub> detector/alarm		
	Air distributors		
	Air compressor		
	Gas blender		
	Gas leak detector		
	Beer gas analyzer		
	Stepless ear clamps		
	Swivel nuts & wing nuts		
	Stems/nipples		
	Splicers		
	Plugs		
	Elbows		
	Y fittings		

**Bar Equipment Shopping List**

Qty	Description	Part Number	Comments
	U-bends/90° bends		
	Tees		
	Crosses		
	Forks		
	Manifolds		
	Compression fittings		
	Hose clamps		
	Hex nuts		
	Unions		
	Adapters		
	Inlet/outlet fittings		
	Washers		
	Fittings kit		
	SS needle valves		
	Wall brackets		
	Beer shut-off valves		
	Beer line saddles		
	Fatlock valves & adapters		
	Fatlock transfer lead		
	John Guest fittings		
	Colder quick couplings		
	Plastic fittings & shutoffs		
	Cleaning bottle/can & adapters		
	Washout pump		
	Clean-in-place (CIP) system		
	CIP chemical dosing board		
	Faucet brush & wrench		
	Hose brush		
	Cleaning/flusher adapters		
	Keg coupler check ball lifter		
	Cleaners		
	Underbar ice chest		
	Underbar bin/bottle well		
	Seamless top station		
	Underbar blender station		
	Underbar drainboard		
	Underbar glass rack		
	Underbar glass cabinet		

